

Technical Specification 150

Warning signs and lights for school buses – Applies to buses first registered on or after 08 February 2019

Version 1 - issued 08 August 2018

Supersedes - nil

1. Purpose

To inform bus owners, operators and manufacturers of the requirements for the safety warning system that must be fitted to buses used for the conveyance of school children. These requirements apply in all areas across New South Wales.

2. Application

This technical specification is approved under clause 25 of the *Road Transport (General) Regulation 2013* and applies to any bus that seats over 12 persons including the driver, which:

- Has been first registered on or after 08 February 2019
- Conveys school children to or from school on weekdays between the hours of 7.00am and 9.30am or 2.30pm and 5.00pm
- Is used solely for the purpose of conveying children to or from school.

For buses first registered before 08 February 2019 the applicable requirements are described in Technical Specification No. 142 'Warning signs and lights for school buses', available from [Roads and Maritime Services](#).

The requirements of this technical specification do not apply to a bus:

- Operating on charter for a school excursion or being used for community service activities, and
- Where no individual fares are being directly collected or school passes including OPAL used.

Buses are exempt from the front sign requirement described in 4.1 if operating as a regular public passenger service.

A passenger service means carrying passengers for a fare or other consideration, according to regular routes and timetables, **but excluding a tourist service or a long-distance service.**

In this context, a tourist service is a pre-booked service, carrying passengers for a fare or other consideration, designed for the carriage of tourists to destinations listed on a publicly available tour itinerary, or where all tourists' journeys have a common origin or a common destination, or both. A long-distance service for this purpose is a public passenger service where passengers are carried for a fare or other consideration according to one or more regular routes, in which each passenger is carried for a distance of no less than 40 kilometres.

3. Introduction

The safety warning system comprises of signs, flashing headlights and flashing warning lights (commonly referred to as 'wigwag' lights) which, when activated, warn approaching motorists that school children are boarding or disembarking from the bus. It is an offence for a driver to pass a bus at a speed more than 40 km/h if it displays signs as shown in Figure 2 below and when the flashing wigwag lights of the safety warning system are activated.

4. Location of signs and wigwag lights

4.1. The words 'SCHOOL SPECIAL' or 'SCHOOL BUS' must be displayed at the front of the bus as described below. Digital displays must not contain any moving signs containing text or graphics that scroll, fade or transition.

- The standard destination sign displays the words 'SCHOOL SPECIAL' or 'SCHOOL BUS' at the front of the bus, or
- A suitable high mounted 'SCHOOL BUS' sign displayed as shown in Figure 1 below. That sign must be mounted no lower than 1800mm above the ground when the bus is loaded and must not interfere with the driver's vision.

Figure 1: Signs and wigwag lights – front

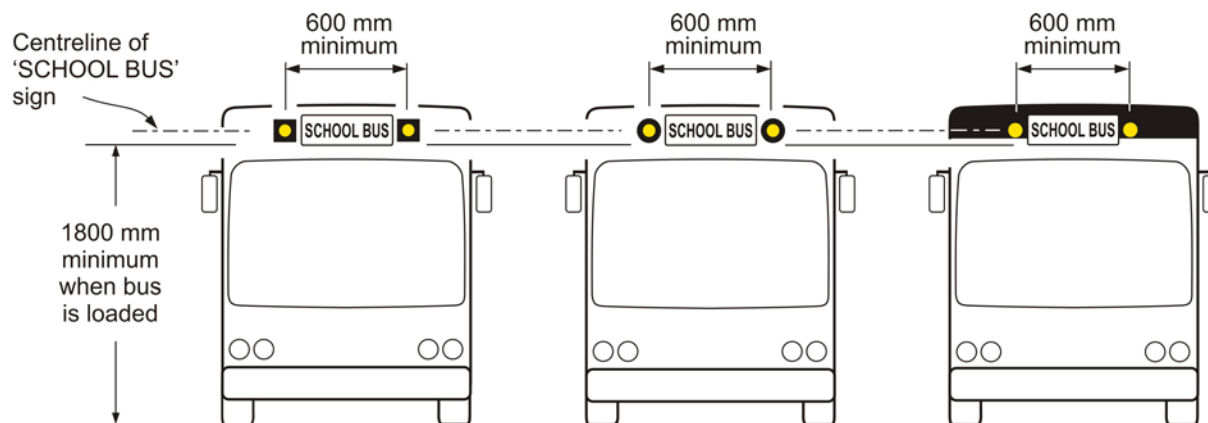

4.2. Signs indicating '40 km/h' and 'WHEN LIGHTS FLASH' must be mounted high on the rear of the bus, evenly displayed on the vertical centreline as shown in Figure 2

Figure 2: Signs and wigwag lights – rear

The signs and wigwag lights must be positioned in one of the configurations shown in the following Figures 2 (i) to 2 (ix):

- The wigwag lights must be spaced evenly about the vertical centreline of the bus (C), and not less than 600mm apart (A)
- For single deck buses the horizontal centreline of the wigwag lights must not be more than 300mm from the top of the bus's rear bodywork (B). See [clause 8.7](#) for double deck buses.

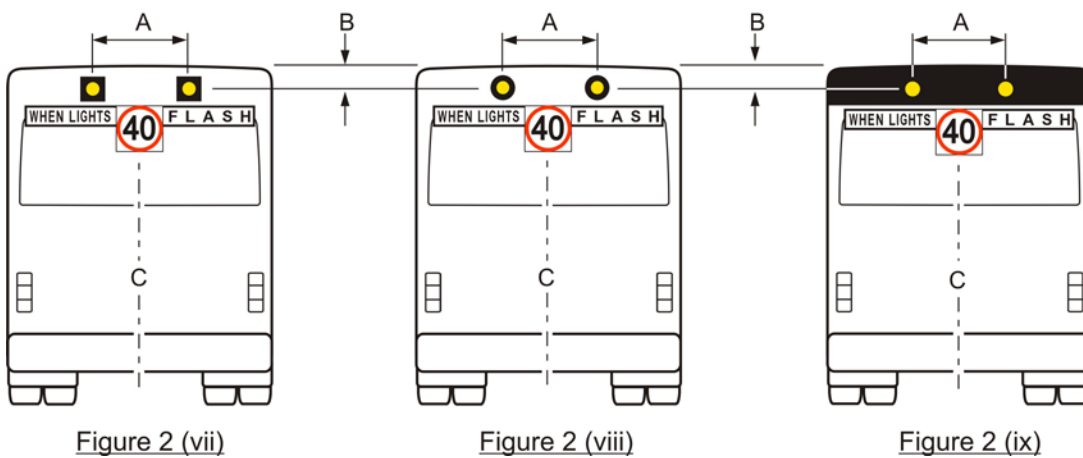
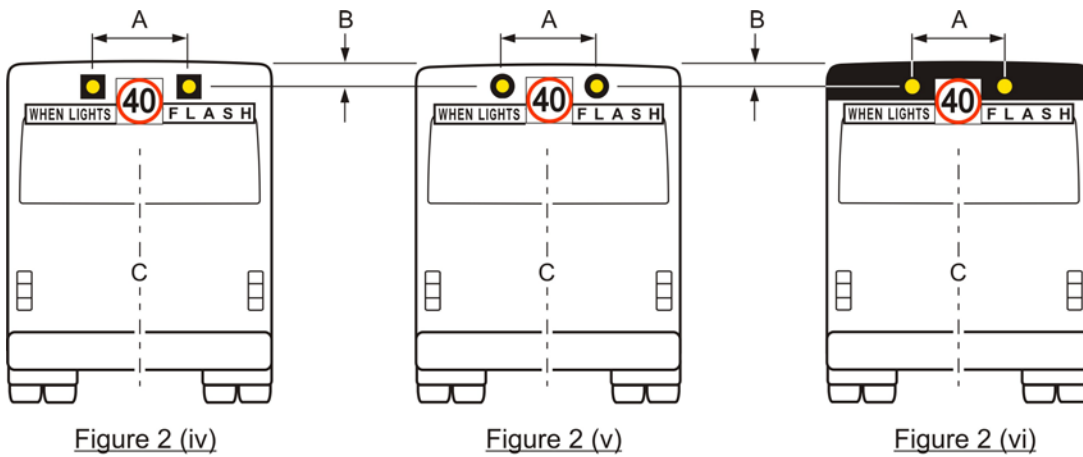
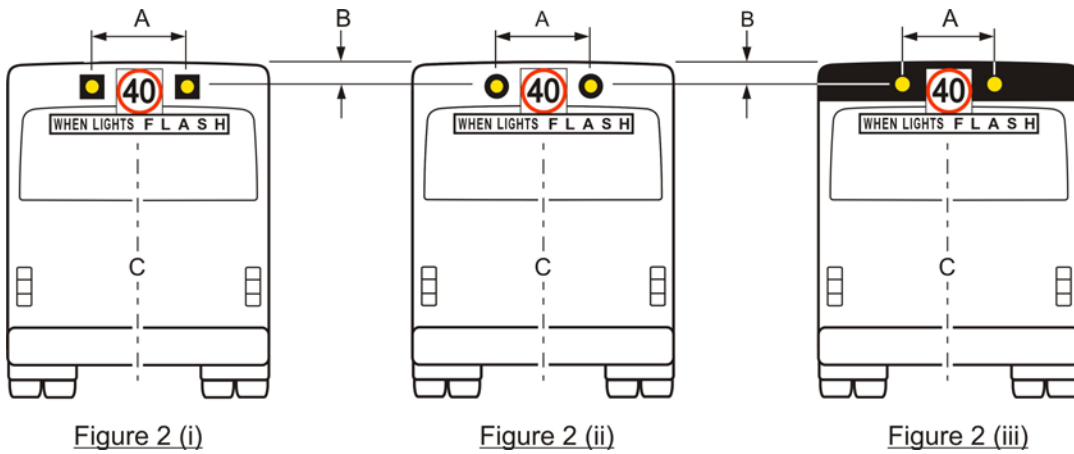

5. '40 km/h' sign

- 5.1. Buses must display a rear '40 km/h' sign that complies with Australian Standard AS 1743 'Road signs - Specifications' ie black numerals on a white reflective background. The annulus around the '40' must be a red reflective symbol
- 5.2. The '40 km/h' sign must meet the dimensions shown in Figure 3 unless otherwise allowed under 5.3

Figure 3: Details of '40 km/h' sign

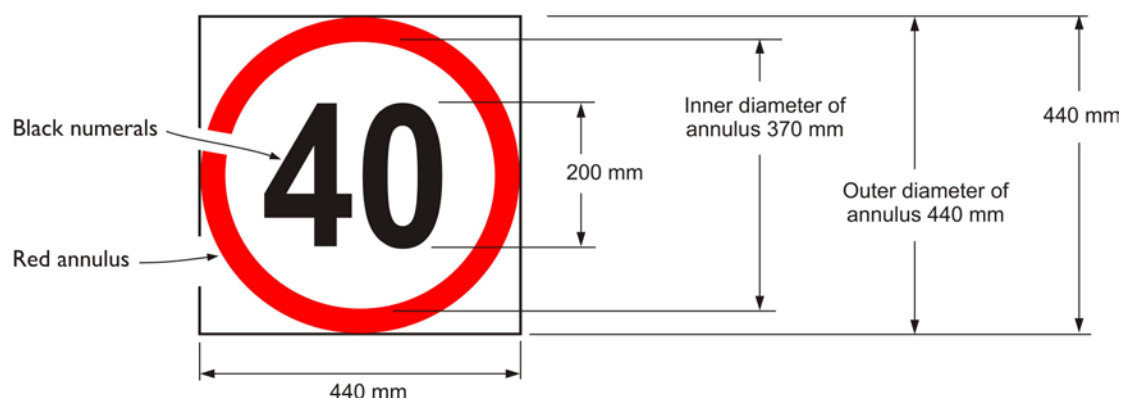

- 5.3. If the physical size of the bus or the space available means the '40 km/h' sign cannot meet the dimensions shown in Figure 3 it may be reduced proportionally to fit the available space, provided the outer diameter of the annulus is not reduced to less than 240mm
- 5.4. The reflective material used must comply with the requirements of AS/NZ 1906 'Retroreflective materials and devices for road traffic control purposes - Retroreflective materials', as amended
- 5.5. The '40 km/h' sign must be fitted in such a manner that the whole sign is displayed perpendicular to the road. The '40 km/h' sign must not be fitted on a curved surface as this may distort its appearance when sighted by a person driving a vehicle approaching directly from the rear of the bus – see Figure 4.

Figure 4: Display of '40 km/h' sign

✓ Acceptable - 40 km/h sign mounted flat ie below curved area of roof

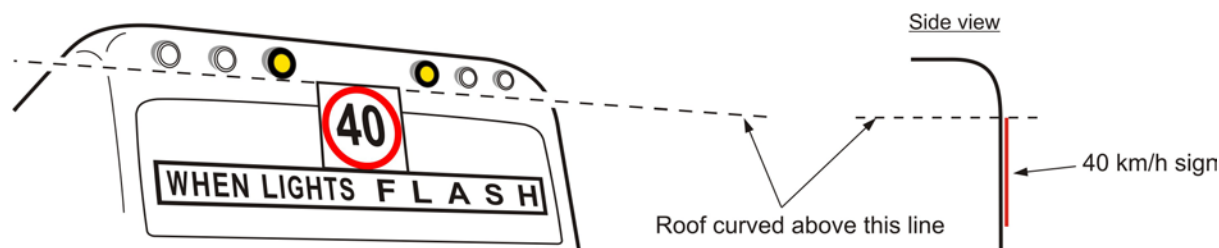

✗ Unacceptable - 40 km/h sign partially mounted on curved area of roof

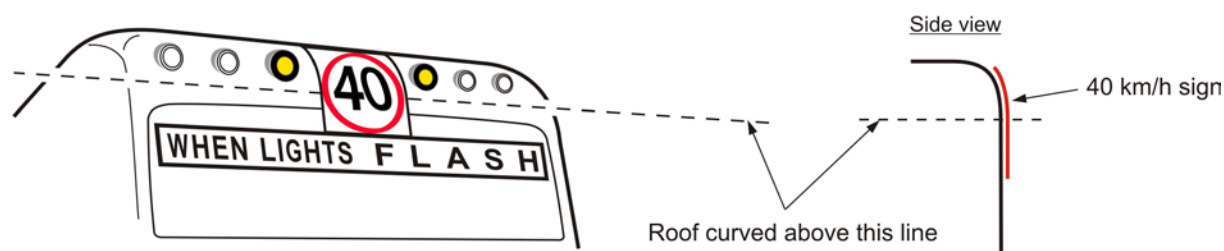

- 5.6. Where a vehicle's design does not allow a symmetrical / central placement of the sign (eg for 2017 Toyota Coaster and all similarly designed buses which have a central brake light taking up the preferred position for the rear mounted '40km/h' sign) the sign should be placed in an off-set position, as near to the vehicle's central vertical line as practicable. An example of suitable placement is indicated in Figure 5. Otherwise, the signage must be consistent with section 5.1 to 5.5 above.

Figure 5 – Example of 40km/h sign for Toyota Coaster buses and all similarly designed buses

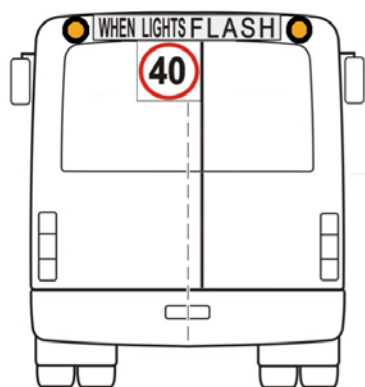

6. 'WHEN LIGHTS FLASH' sign

- 6.1. Buses must display a 'WHEN LIGHTS FLASH' sign that meets the dimension requirements shown in Figure 6 below, unless otherwise allowed under clause 6.2
- 6.2. If the physical size of the bus or the space available means the sign cannot meet the dimensions shown in Figure 6, a smaller sign may be fitted providing the characters are not less than 60mm in height – see Figure 7 below
- 6.3. The sign must use characters as described in AS 1744 'Forms of letters and numerals for road signs' as follows:
 - The words 'WHEN' and 'LIGHTS' must use series C characters with narrow letter spacing
 - The word 'FLASH' must use series E characters with the letters spaced evenly.
- 6.4. The 'WHEN LIGHTS FLASH' sign may be separated into two signs; 'WHEN LIGHTS' and 'FLASH', and attached as shown in Figure 2. The dimensions of the individual signs must at least meet the requirements shown in Figure 6 below.

Figure 6: details of 'WHEN LIGHTS FLASH' SIGN/S

(All dimensions in millimetres)

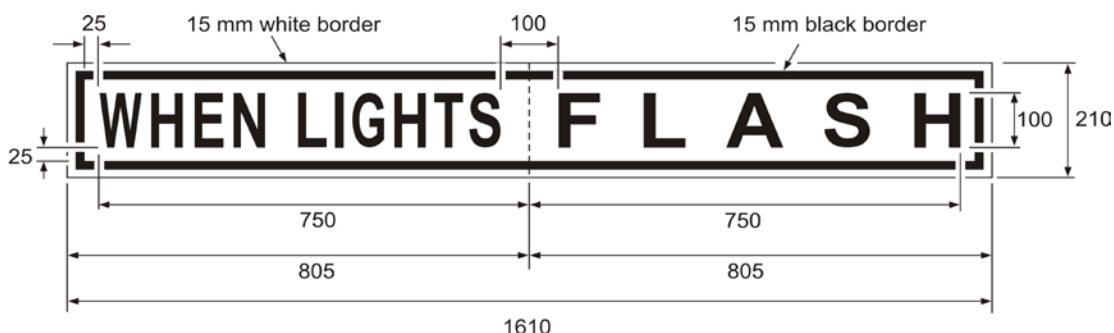
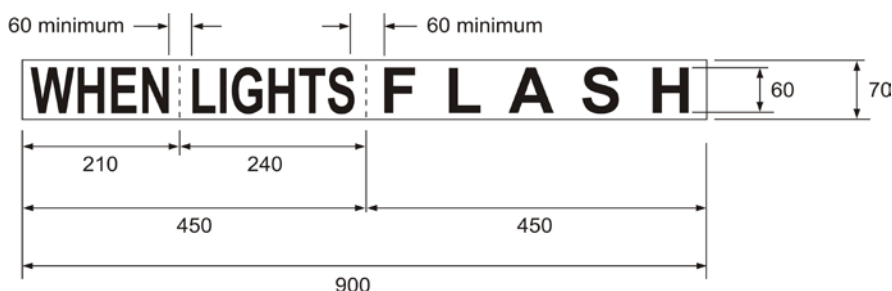

Figure 7: details of 'WHEN LIGHTS FLASH' sign (if 6.2 applies)

(All dimensions in millimetres)



7. Visibility of signs

- 7.1. All signs must be placed on the bus so that their appearance (as shown in Figure 1 and Figure 2), is not distorted when sighted by a person driving a vehicle approaching directly from the front or rear of the bus
- 7.2. To ensure the warning signs are clearly visible to drivers of following vehicles, the area around the signs must be free of advertising material. To achieve this, the rear of the bus is divided into two zones as shown in Figure 8 below.

Zone 1 is the area across the whole width of the rear of the bus above a horizontal line which is 100mm from the lowest edge of the '40 km/h' or 'WHEN LIGHTS FLASH' sign, whichever is in the lower position.

Zone 1 must be free of any advertising text and image, any material in zone 1 must be either in a monochromatic colour scheme or transparent and clear without any colour. Additional mandatory signs may be placed in zone 1 providing they do not obscure the safety sign.

Zone 2 is the area across the whole width of the rear of the bus below a horizontal line which is 100mm from the lowest edge of the '40 km/h' or 'WHEN LIGHTS FLASH' sign, whichever is in the lower position.

Zone 2 is the area where advertising material is permitted.

Figure 8: Advertising zones

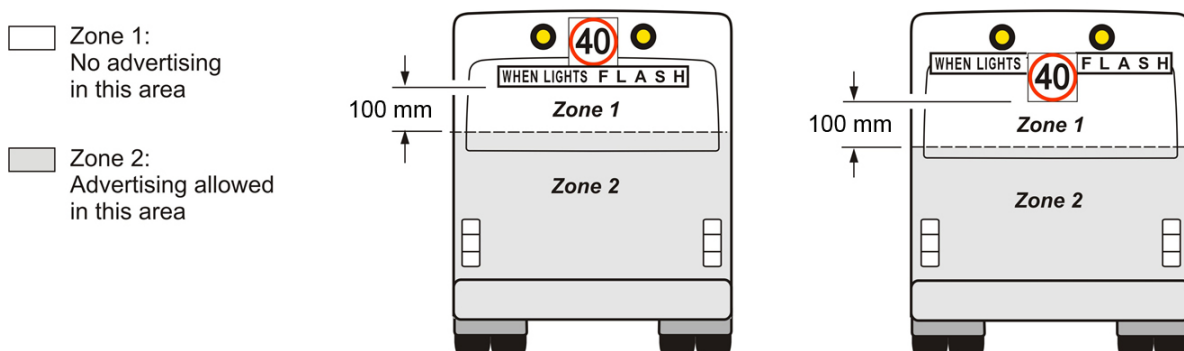

8. Wigwag light requirements and operation

- 8.1. Wigwag lights must be installed on the front of the bus as shown in [Figure 1](#)
- 8.2. Wigwag lights must be installed on the rear of a single deck bus as shown in [Figure 2](#)
- 8.3. The front wigwag lights must be mounted symmetrically about the vertical centreline of the bus
- 8.4. The front wigwag lights should be mounted along the horizontal centreline of the SCHOOL BUS sign and not less than 600mm apart as shown in [Figure 1](#), unless otherwise allowed under clause 8.5
- 8.5. If it is not practical to mount the wigwag lights along the horizontal centreline of the SCHOOL BUS sign, they may be located immediately above or below the horizontal centreline of the sign, provided that both lights are mounted at the same vertical height
- 8.6. For a single deck bus the rear wigwag lights must be mounted symmetrically about the vertical centreline of the bus and no lower than 300mm below the top of the bus as shown in [Figure 2](#)

- 8.7. For a double deck bus the rear wigwag lights must be mounted symmetrically about the vertical centreline of the bus in zone 1. Their location should be as high up on the bus as reasonably practicable given the design of the bus, providing the best possible visibility to approaching drivers
- 8.8. The lens of each wigwag light must have an effective lit lens area of at least 60cm²
- 8.9. The area of the bus immediately surrounding each wigwag light and extending outwards must be black for at least 70mm. This requirement applies to wigwag lights fitted at the front and rear of the bus. If the wigwag lights are fitted on a black background of at least a comparable size to the black border, this requirement is considered as being met
- 8.10. The wigwag lights must emit a flashing yellow (or amber) coloured light
- 8.11. The luminous intensity (in candela) of the light emitted by a wigwag light must comply with the values shown in Table 1 when measured at the specified angles

Table 1: Luminous intensity (in candela) of a wigwag light

Vertical angle from centre of light	Horizontal angle from centre of light								
	- 30 ⁰	- 20 ⁰	- 10 ⁰	- 5 ⁰	0 ⁰	5	10 ⁰	20 ⁰	30 ⁰
10 ⁰				50	80	50			
5 ⁰		180	320	350	450	350	320	180	
0 ⁰	75	450	1000	1250	1500	1250	1000	450	75
-5 ⁰	40	270	450	570	600	570	450	270	40
-10 ⁰				75	75	75			

- 8.12. The luminous intensity of a light is to be measured using the test method mentioned in third edition ADR 6/00 'Direction Indicators'
- 8.13. Each light in the pair of wigwag lights must flash alternately with a frequency of 90 to 180 times per minute
- 8.14. When the wigwag lights are required to operate, they must activate automatically and within one second of any passenger door opening. The wigwag lights must then continue to operate while any passenger door is open and must continue to operate for at least 10 seconds, and not more than 20 seconds, after all the doors on the bus have closed.

9. Headlight requirements and operation

- 9.1. The bus's mandatory dipped-beam (ie low-beam) headlights, or an optional pair of dipped-beam headlights, must flash alternately, ie between the right and left headlights, whenever the wigwag lights are activated. They must:
- Flash only while a passenger door is open and the bus is stationary
 - Cease flashing immediately when all passenger doors are closed.
- 9.2. In addition to the requirements of clause 9.1 above, any optional pair of dipped-beam headlights fitted to the bus and used as flashing lights must:
- Be the same wattage as the bus's mandatory dipped-beam headlights
 - Be fitted to the front of the bus as shown in Figure 9
 - Not dazzle other road users either directly (oncoming vehicles) or indirectly through rear view mirror/s etc
 - Not be strobe lighting.

9.3. Main-beam (ie high-beam) headlights must not be used as flashing headlights.

Figure 9: Location of optional dipped-beam headlights

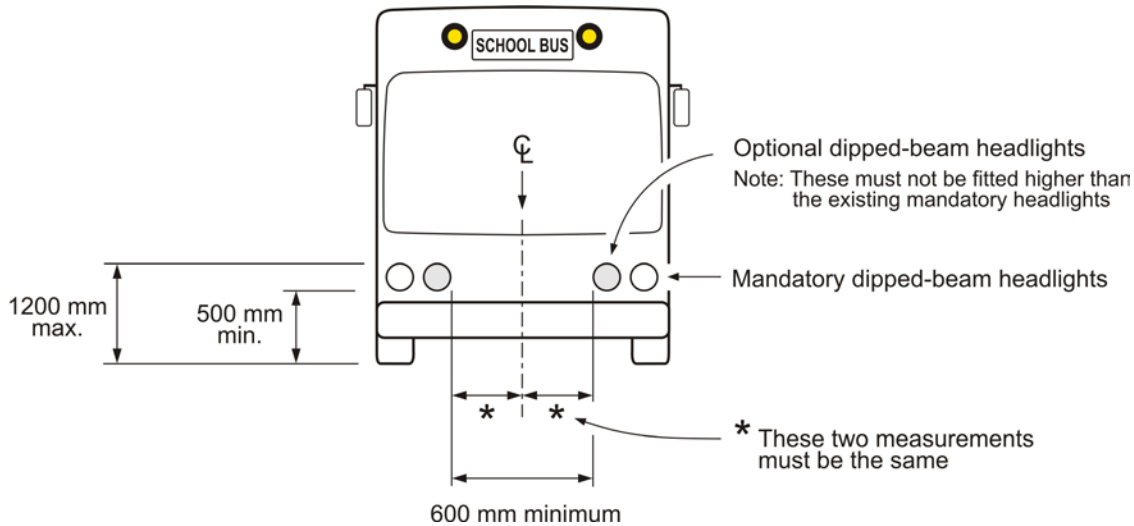

10. General requirements

- 10.1. An isolating switch must be installed that controls the operation of the flashing lights (headlights and wigwag lights)
- 10.2. The location of the signs or wigwag lights must not interfere with the operation of any passenger emergency exit. This may be achieved by cutting or scoring the sign such that it will tear if any force is applied to it. If the sign is cut the parts must be butted together without any gap between the pieces.

Further information

Roads and Maritime Technical Enquiries

Telephone: 1300 137 302

Fax: 02 8837 0037

Email: Technical.Enquiries@rms.nsw.gov.au

PO Box 1120, Parramatta NSW 2124

New South Wales Legislation

www.legislation.nsw.gov.au

Telephone: 02 9321 3333