



Special Commission of Inquiry

Acute Care Services in NSW Public Hospitals

Final Report of the Special Commission of Inquiry Acute Care Services in NSW Public Hospitals

Volume 1

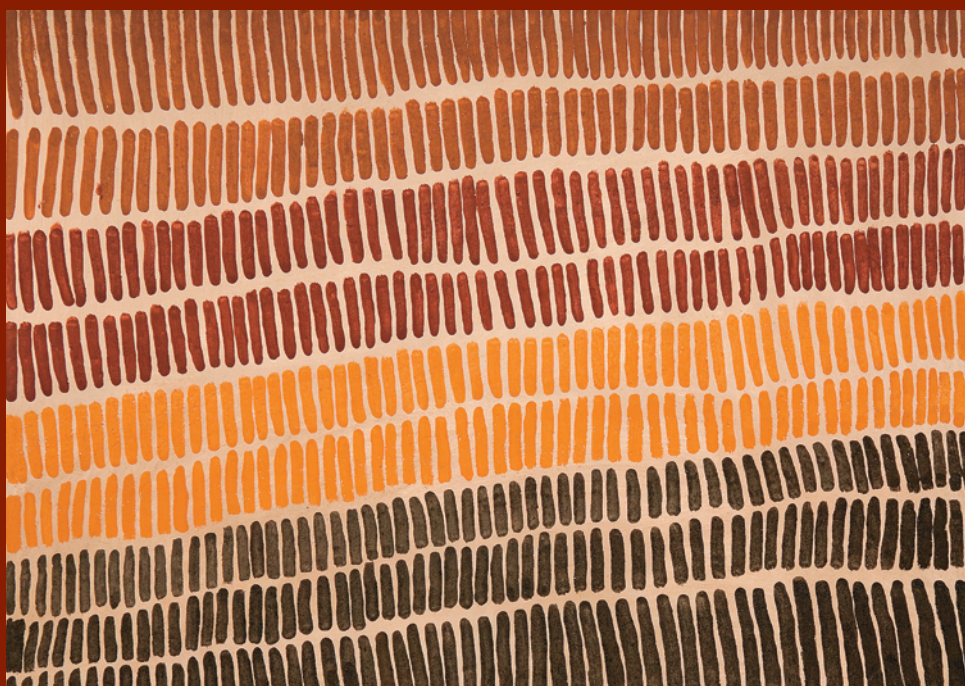

Peter Garling SC
27 November 2008

© State of NSW through the Special Commission of Inquiry:
Acute Care Services in New South Wales Public Hospitals

ISBN 978-1-921301-81-0

Final Report of the Special Commission of Inquiry:
Acute Care in NSW Public Hospitals, 2008 - Volume 1 (print)

(<http://www.lawlink.nsw.gov.au/acsinquiry>)

Published 27 November 2008

The painting on the report's cover is
'Jimbala Ngarrangkarni', 2001 by the renowned artist Lena Nyadbi.
It is reproduced here with her kind permission.



Special Commission of Inquiry

Acute Care Services in NSW Public Hospitals

**Final Report of the
Special Commission of Inquiry
Acute Care Services in
NSW Public Hospitals**

Volume 1

Peter Garling SC
27 November 2008



Special Commission of Inquiry
Acute Care Services in NSW Public Hospitals

Level 6, 299 Elizabeth Street, Sydney 2000
PO Box A4, Sydney South NSW 1235
Tel 02 9374 4200 | Fax 02 9374 4222
acutecare.inquiry@agd.nsw.gov.au

27 November 2008

Her Excellency Professor Marie Bashir AC CVO
Governor of the State of New South Wales
Office of the Governor
Macquarie Street
SYDNEY NSW 2000

Your Excellency,

I was appointed by Letters Patent issued on 29 January 2008 under the *Special Commissions of Inquiry Act 1983* (NSW) to inquire into and report to Your Excellency on matters concerning the delivery of acute care services in public hospitals in New South Wales.

As part of the Inquiry, I presented an initial report investigating the circumstances surrounding the appointment in 2002 of former registered medical practitioner Graeme Stephen Reeves on 31 July 2008.

I have completed my report and I am now in a position to present my final report, which consists of three volumes. I have also prepared a single volume overview of my report.

I have the honour to present my Report of the Special Commission of Inquiry for Your Excellency's consideration.

Yours faithfully,

Peter Garling SC
Commissioner

Table of contents

Volume 1

Table of contents.....	i
Preface	iii
List of recommendations	v
1 What led to this Inquiry and how it was done.....	1
PART A PATIENTS	
2 Patients	19
3 Chronic, complex & elderly patients.....	39
4 Mothers.....	77
5 Babies, children and young people.....	97
6 Rural patients.....	127
PART B WORKFORCE	
7 Doctors.....	187
8 Nurses	241
9 Allied health & pharmacy	289
10 Education & training	321
11 Workforce reforms	363
12 Bullying & workplace culture	399

Volume 2

PART C COMMUNICATION	
13 Supervision of junior clinical staff.....	427
14 Clinical records & Information Technology	459
15 Communication	517
PART D PATIENT SAFETY	
16 Safety & quality	581
17 Key performance indicators	653
18 Hospital acquired infection.....	669
19 Deteriorating patients.....	703
PART E AREAS OF MEDICAL TREATMENT	
20 Emergency Department	715
21 Community health	773
22 Mental health	793
23 Surgery	827
24 Pathology & medical imaging	849

Volume 3

PART F PRACTICAL COMPONENTS

25	Funding	877
26	Hospitals	921
27	Transport.....	957
28	Beds	985
29	Food	1011
30	Equipment.....	1025
31	Administration & management.....	1047

PART G ENSURING CHANGE

32	Ensuring change	1107
----	-----------------------	------

APPENDICES

Appendix 1	Terms of reference	1113
Appendix 2	Submissions received.....	1119
Appendix 3	Hospitals visited.....	1135
Appendix 4	Hearings and public witnesses	1137
Appendix 5	Meetings	1151
Appendix 6	Expert panels.....	1161
Appendix 7	Feedback forums.....	1165
Appendix 8	Shellharbour	1169

Preface

- 1.1 This report is voluminous and detailed. It follows a lengthy Inquiry.
- 1.2 As I explain in Chapter 1, the process, which I followed, attempted to engage as many of those involved in providing health care in the public hospitals of NSW as was possible.
- 1.3 I was, and remain, as an outsider privileged to have been taken into the confidence of those who have spent their professional lives working for the good of their patients and the public of NSW.
- 1.4 I am grateful to all those clinicians, health care workers, managers, administrators and patients who took the time to provide submissions and assistance to my Inquiry. Some gave evidence to me. Others patiently showed me their facilities and answered my questions. Without their input, this Inquiry and Report would not have been possible.
- 1.5 I had the benefit of an outstanding staff.
- 1.6 Terence Tobin QC, Senior Counsel Assisting, provided me with the benefit of his considerable wisdom and guidance throughout the Inquiry.
- 1.7 The work of Ms Kelly Rees as Counsel Assisting in marshalling the Inquiry's activities, in overseeing the preparation of the Report and providing sound, direct and fearless advice has been outstanding. Without her contribution, this report could not have been produced within the time given to me.
- 1.8 Ms Georgina Wright was the Junior Counsel Assisting the Inquiry. Her contribution has been of the highest order. Her thoughtfulness, eye for detail and intellectual rigour made a significant contribution to my work.
- 1.9 I have been assisted by solicitors, para-legals and administrative staff provided to me by the Crown Solicitors Office. Without the prompt and full cooperation of the NSW Crown Solicitor, the establishment of this Inquiry and its work would not have been possible.
- 1.10 Ms Catherine Follent has been the Principal Solicitor for the Inquiry. She has been a pillar of strength. I have come to rely upon her and Ms Clare Miller, the Senior Solicitor for the Inquiry with complete confidence throughout my Inquiry. Their work has been highly professional, careful and sensitive. It is they who have had the task of dealing with many of those who interacted with the Inquiry. My reliance upon Ms Follent and Ms Miller was very great. They bore that burden with equanimity and good humour. For that I am most grateful.
- 1.11 All members of my staff have contributed and assisted in the preparation of the report in one way or another. If the report has any redeeming qualities that is due entirely to the hard work of my staff. The errors, mistakes, misjudgements and inadequacies in it are entirely mine.
- 1.12 Finally, I wish to commend the work of Mr Bob Young, the Executive Officer of the Inquiry. It is he whose work has ensured the processes necessary to support an Inquiry of this kind. It is he who has borne that unenviable burden with professionalism, efficiency and cheerfulness. Nothing was too difficult for him to attend to. He has my gratitude.



List of recommendations

	page
Chapter 2 Patients recommendations	
Recommendation 1: <i>NSW Health should consider whether in the interests of public education and information it would be feasible to provide to patients upon discharge from public hospitals either an itemised listing of the cost of their care based on the relevant case-mix formula or else to make publicly available the average cost of typical interventions and treatments.</i>	30
Recommendation 2: <i>In order to improve the availability of interpreting services in public hospitals for non-English speaking patients, each Area Health Service must investigate the sufficiency of, and ensure the adequacy of, the hands free communication equipment available in each hospital to maximise the opportunities for the use of the telephone interpreter service.</i>	35
Chapter 3 Chronic complex and elderly recommendations	
Recommendation 3: <i>NSW Health’s Severe Chronic Disease Management Program should be implemented and expanded to include all “very high risk” and “high risk patients” over the age of 18.</i>	50
Recommendation 4: <i>NSW Health should consider and develop a comprehensive plan for the expansion of Hospital in the Home programs of care for chronic and complex patients. The program should be implemented throughout NSW hospitals within 18 months.</i>	54
Recommendation 5: <i>NSW Health should liaise with the Guardianship Tribunal to ensure that patients within acute care services in NSW public hospitals who are medically fit for discharge be given the appropriate priority for a hearing by the Tribunal.</i>	60
Recommendation 6: <i>Aged Care Assessment Team assessments of inpatients should be planned to commence as early in a patient’s stay in hospital as is possible so that they are completed at the time the patient is medically ready for discharge.</i>	61
Recommendation 7: <i>The Clinical Innovation and Enhancement Agency should as a matter of priority develop a model of care (a) that allows identification of those elderly patients for whom a hospital stay in the event of deterioration would be likely to result in adverse health outcomes; and (b) which outlines the appropriate treatment modalities for such patients out of hospital.</i>	65

Chapter 4 Mothers recommendations

Recommendation 8: *NSW Health should address the following matters with respect to its maternity services:* 90

- (a) *Within 12 months, NSW Health consider and determine whether area health services be permitted to enter into “fee for service” contracts with midwives, including determining what arrangements with NSW Treasury are necessary in relation to the extension of current indemnity to cover such midwives;*
- (b) *NSW Health, through the area health services, identify which hospitals would be appropriate for the introduction of a caseload model of maternity care in addition to, or in lieu of full-time maternity services. Following the review, NSW Health is to plan for the introduction of that model of care, where viable on a clinical needs basis and subject to available funding;*
- (c) *In the interests of patient safety, NSW Health only offer birthing facilities for low risk mothers in hospitals which satisfy the following criteria:*
 - (i) *the hospital has an adequate number of health professionals qualified and trained to assist with the birth, such as midwives or VMOs with the necessary credentials; and*
 - (ii) *the hospital has, on-site, or else has the ability to transfer the mother within 30 minutes travel time to a hospital which has on-site, the workforce and facilities to perform an emergency caesarean section.*

Chapter 5 Babies, children and young people recommendations

Recommendation 9: *Within 6 months, NSW Health should establish, as a chief-executive governed statutory health corporation pursuant to s.41 of the Health Services Act 1997, a Children and Young Peoples’ Health Authority (“NSW Kids”).* 120

The function and role of NSW Kids will be to provide all health care for children and young people, throughout NSW, whether in the community, or in a public hospital, commencing with neo-nates who require tertiary or higher level services and concluding with young people at the end of their sixteenth year of life.

The guiding principle of NSW Kids is that the paramount consideration in the provision of health care is the promotion of the health and well-being of the population and the prevention, diagnosis, treatment and cure of the illnesses of the population in a manner which best promotes the wellbeing of children and young people.

The principal purposes of NSW Kids are to include, at least:

- (a) The striking of, and the maintenance of, a proper funding balance between the provision of community based services, including inter-agency co-operation and prevention measures, and the provision of acute care and related services in public hospitals;*
- (b) Ensuring that the standard of all health care provided to children and young people throughout public hospitals in NSW is consistent and is undertaken, so far as possible, in facilities or parts of facilities which are designated and set aside for such care and which do not include the provision of care for adults; and*
- (c) Ensuring that there are adequate services and facilities for the provision of mental health care to children and young people.*

The secondary purposes of NSW Kids are to include, at least:

- (a) the provision of education and training to all clinicians about the health and well-being of children and young people;*
- (b) the provision, either alone or in conjunction with NSW Health and the Area Health Services, of public education, including preventative health and wellness campaigns, which promotes the health and well-being of children and young people throughout NSW; and*
- (c) the commissioning, conducting, supporting and supervision of research into the health and well-being of children and young people.*

Recommendation 10: *Within 12 months, NSW Kids should publish and implement, a strategic service delivery plan for the health care of children and young persons so as to ensure that appropriate treatment is delivered by appropriately skilled clinicians in the appropriate facility or else as a community based service. Such plan is to delineate clearly which health service is to be provided in which facility or class of facilities, including the criteria for transfer between facilities, and should, so far as clinically appropriate, avoid the duplication of services between facilities. In the development of the strategic service delivery plan, NSW Kids, determine whether it is in the best interests of the health of children and young people that all Sydney metropolitan area based intensive care units (providing tertiary and quaternary care for neo-natal and paediatric patients) should be combined into a single unit at a single facility and whether there should be established a similar facility at the John Hunter Children's Hospital.*

120

Recommendation 11: *Within 18 months, NSW Kids should investigate and report to NSW Health and the Minister for Health on the need for, the desirability of, and the possible locations of a new NSW Kids hospital providing quaternary and tertiary facilities. Any such report needs to include preliminary costings for and a business case which analyse the best options for a new NSW Kids hospital.*

121

Chapter 6 Rural recommendations

Recommendation 12: *NSW Health should take immediate steps to enhance the supply of a skilled workforce of clinicians to rural areas by ways which include, at least:* 139

- (a) *Giving consideration to whether there is an available process by which there ought be made compulsory a rural training term for employed junior medical officers in their second and third year of employment with NSW Health, including reviewing which hospitals have the capacity to accept such trainees and what other steps are necessary to ensure the adequacy of the training of such junior medical officers undertaking a rural term;*
- (b) *Reviewing the existence of and developing, as required, employment packages with features which would attract and retain skilled staff to work in rural communities. This may include developing formalised partnership structures between metropolitan hospitals and rural hospitals which facilitate the transition of clinicians between the hospitals.*
- (c) *Developing education facilities and programs which ensure that clinicians working in the rural and remote areas of NSW are provided with adequate education and training.*

Recommendation 13: *NSW Health should seek an amendment to the Mental Health Act 2007 to permit suitable remote facilities, specified in regulations to the Act, to operate safe assessment rooms for mental health patients on the basis that 3 hourly review of the patient may be undertaken by a senior nurse or psychiatrist over a video link.* 166

Recommendation 14: *NSW Health should address the transport problems associated with providing care for rural patients including:* 169

- (a) *Abolishing the personal contribution and administration charge for all qualifying IPTAAS claims;*
- (b) *that there is a need to create a non urgent transport service to be responsible for the return transport of patients from metropolitan or rural hospitals to either their hospital of origin or alternatively to their homes, depending upon their clinical condition.*

Chapter 7 Doctors recommendations

Recommendation 15: *NSW Health design and implement a business information system that records current medical workforce according to specialty if any, qualifications, location and stage of training, to enable workforce planning to be undertaken in a coordinated manner. This system should be available within 18 months.* 199

Recommendation 16: *NSW Health ought review its policies and practices with respect to the recruitment of medical staff (other than junior medical officers) so as to require clear identification of the available senior medical officer positions by number and description which are unfilled and the date such positions became vacant, and which ensures that the recruitment of such medical officers occurs without any unnecessary or unintended delays. Each area health service should display, updated monthly, a complete list of all vacancies on the NSW Health intranet, together with the date when the position first became vacant.* 202

Recommendation 17: *NSW Health ought consider the enhancement of its medical workforce by:* 206

- (a) *Reviewing the number and adequacy of prevocational and vocational places in rural regional and outer metropolitan areas so as to ensure a secure career path for medical officers who wish to work in these areas;*
- (b) *Identifying the extent of the current shortage of general physicians and taking steps to ensure that there are created appropriate number of training places so as to enable the current shortage of general physicians to be addressed;*
- (c) *Creating the role of a clinical support officer for doctors, designed to be able to assist in the undertaking of their roles and ensuring that their time is dedicated to clinical tasks rather than non-clinical workload.*

Recommendation 18: *The NSW Minister for Health should consider, having regard to any advice from the NSW Medical Board, whether it would be appropriate to impose on all registered medical practitioners a mandatory obligation to undertake continuing professional education in each year of practice, and, if so, whether any amendments are necessary to the Medical Practice Act 1992 (NSW).* 216

Recommendation 19: *Within 12 months, NSW Health should create a casual medical workforce:* 221

- (a) *By instituting and maintaining a centralised register recording the details of all doctors, including their credentials and experience, who are available to fill casual shifts or to act as locums for specified periods;*
- (b) *By including on the centralised register the details of any currently employed or contracted specialists who are available to fill shifts on a casual basis;*
- (c) *Which is subject to appropriate performance reporting and performance management systems which are designed to ensure the continued competency of those on the list; and*
- (d) *Which has access to and is encouraged to undertake education and training so as to ensure the maintenance of and improvements in their skills and competence.*

Recommendation 20: *NSW Health should review the current induction program which is undertaken for overseas trained doctors prior to them commencing employment in the NSW public hospital system, and enhance it so as to make more efficient and effective the employment of overseas trained doctors.* 224

Recommendation 21: *NSW Health should implement within 12 months a program which ensures that an annual performance review for each employed or contracted doctor, other than a doctor in training, is undertaken jointly by a senior clinician and a management representative.* 228

In order to enable an annual performance review program to occur, NSW Health should ensure there exists for each position to be reviewed a job description identifying:

- (a) roles and responsibilities for each designation and position held by a doctor;*
- (b) performance criteria for inclusion in contracts with respect to each position held by a doctor.*

Chapter 8 Nurses recommendations

Recommendation 22: *NSW Health should review the current induction program which is undertaken for overseas trained nurses prior to them commencing employment in the NSW public hospital system, and enhance it so as to make more efficient and effective the employment of overseas trained nurses.* 253

Recommendation 23: *NSW Health should, as a matter of priority, review and redesign the role of the nurse unit manager (“NUM”) so as to enable the NUM to undertake clinical leadership in the supervision of patients and the enforcement of appropriate standards of safety and quality in treatment and care of patients in the unit or ward for which they are responsible. This redesign needs to encompass either the transfer of a range of duties from the NUM to other existing staff members or alternatively the creation of a role of clinical assistant to the NUM to undertake those tasks. . The aim of the redesign is to ensure that at least 70% of the NUM’s time is applied to clinical duties and no more than 30% of the time is applied to administration, management and transactional duties.* 262

Recommendation 24: *All hospitals employing nurse unit managers report within 6 months to the Chief Nurse of NSW Health how they will re-allocate the duties currently being undertaken by the NUM in line with my earlier recommendation and all hospitals employing NUMs should complete the implementation of the redesigned role within 2 years.* 262

Recommendation 25: *I recommend that NSW Health, in order to address the current shortages in the nursing workforce, consider and implement, if appropriate, the following:* 277

- (a) The creation of a new clinical designation for registered nurses with over 10 years experience who continue to carry out patient clinical care, entitled “Senior Registered Nurse” with appropriate competency based increments.*

- (b) *The allocation of funding for more nurse practitioner positions across NSW, particularly in rural and remote areas, and in hospitals where it is hard to employ doctors.*
- (c) *A redesign of the General Workload Calculation Tool to take into account nurses' designation (clinical nurse specialist, registered nurse, enrolled nurse, trainee enrolled nurse, assistant-in-nursing) and years of nursing experience, together with the capacities created by a team-based nursing medical of care.*

Chapter 9 Allied Health & Pharmacy recommendations

Recommendation 26: *I recommend that NSW Health address deficiencies in the workforce of and delivery of services by allied health professionals in public hospitals by considering and implementing a program which addresses the following matters:*

301

- (a) *The institution of policies which mandate timely action for dealing with vacancies of allied health professionals so as to ensure that replacements occur when allied health staff are on annual leave, maternity leave or long service leave or any other period of leave which exceeds 5 working days;*
- (b) *Enhancing allied health services in hospitals by providing for allied health staff either to be rostered for at least two shifts a day and to be on call for a third shift or else taking other steps to ensure that there is available an adequate supply of allied health services to inpatients on all 7 days of the week;*
- (c) *Ensuring that when new models of care are introduced which require input by allied health professionals that the appropriate contribution by those allied health professionals is sought, recognised and incorporated into the model of care. It will be necessary to ensure adequate funding for such allied health participation;*
- (d) *Determining the appropriate means by which allied health professionals should receive adequate ongoing education and providing such education and training.*

Page xi

Recommendation 27: *A director or co-ordinator of allied health services be appointed in each hospital or hospital facility. That person should be a senior allied health practitioner with knowledge of the range of all allied health roles.*

303

Recommendation 28: *NSW Health should ensure that there is developed standard guidelines which involve consultation by and the participation of clinical pharmacists in the care of patients at the earliest appropriate opportunity so as to enable a clinical pharmacist to take a patient's medication history, participate in ward rounds, review the patient's medical chart during their inpatient stay and review medications on discharge.*

306

Recommendation 29: <i>NSW Health consider the enhancement of the clinical pharmacists' work force in public hospitals by:</i>	308
(a) <i>encouraging the obtaining of higher qualifications by clinical pharmacy staff;</i>	
(b) <i>incorporating for clinical pharmacists a component relating to training time both of pre-registration pharmacists (or trainees), new graduates in the hospital, and by the provision of clinical pharmacy educator;</i>	
(c) <i>fostering arrangements with community pharmacists so as to encourage a better exchange of pharmacists between the community and the hospital; and</i>	
(d) <i>identifying the tasks which may be performed by a pharmacists assistant and designing a position for such an assistant in order to free up a clinical pharmacist to spend more time engaged in patient care.</i>	

Chapter 10 Education & Training recommendations

Recommendation 30: <i>Benchmarks which adequately measure the extent of the delivery of postgraduate clinical education and training should be included in performance agreements between NSW Health and area health services and statutory health corporations.</i>	324
Recommendation 31: <i>NSW Health should review, develop if required and implement such policies as will clearly specify the roles and responsibilities of the Institute of Clinical Education and Training and the roles and responsibilities of area health services and relevant statutory health corporations in the delivery of training and education relevant to health services.</i>	333
Recommendation 32: <i>NSW Health should ensure that all hospital directors and supervisors of training for prevocational doctors are provided with protected time each week to carry out their duties in relation to training and formal teaching within the hospital. This time should be protected as part of the terms of employment and through the employment performance management process.</i>	339
Recommendation 33: <i>NSW Health should require all clinicians who are engaged in the teaching and/or supervision of postgraduate clinical staff to satisfactorily complete courses provided by the Institute of Clinical Education and Training directed to enhancing their skills as teachers, trainers and supervisors.</i>	339
Recommendation 34: <i>NSW Health should explore the opportunities for and develop programs which attract senior clinicians to become involved in or else increase their involvement in, the teaching and supervision of junior clinical staff, including by developing appropriate positions and career streams for such senior clinicians.</i>	339

Recommendation 35: *NSW Health should consider the enhancement of the training and education provided for allied health professionals, by, at least:* 348

- (a) *Considering the provision of funding directly, or else indirectly through payment of allowances for attendance at, and participation in external education and training courses relevant to the particular allied health specialty; and*
- (b) *Considering whether it would be appropriate and cost effective to create specific positions for the provision of education to the particular allied health specialties.*

Recommendation 36: *Within sixth months, NSW Health is to establish a chief executive governed statutory health corporation pursuant to s.41 of the Health Services Act 1997 to fulfil the role of a NSW Institute for Clinical Education and Training. The Institute is to have, at least, the following principal purposes and functions:* 353

- (a) *to design, institute, conduct and evaluate a program for the postgraduate clinical education and training for all new postgraduate professional clinical staff employed in NSW public hospitals;*
- (b) *to design, institute, conduct and evaluate leadership training for clinicians to enable clinicians to become clinical leaders and also health system leaders;*
- (c) *to design, institute, conduct and evaluate training for clinicians to enable clinicians to become skilled teachers and trainers for the trainees in all of the programs conducted by the Institute;*
- (d) *to design, implement and oversee an appropriate performance evaluation program for professional clinical staff whilst undergoing postgraduate clinical training; and*
- (e) *to design, implement, conduct and evaluate clinical education and training to enable medical practitioners to be qualified, competent and capable of practising as hospitalists in NSW public hospitals.*

The Institute is to have at least, the following secondary purposes and functions:

- (a) *to liaise with the College of Nursing so as to ensure that the postgraduate education and training programs are appropriately designed and delivered; and*
- (b) *to liaise with the Deans of tertiary education institutions which provide undergraduate education in the various Health Science disciplines at, or with the assistance of, NSW public hospitals in order to identify all synergies between the clinical education and training of undergraduates and post-graduate trainees and to seek to make more efficient the respective education and training regimes, including the delivery of the education and training; and*
- (c) *to liaise with the various medical colleges which provide vocational education and training for medical practitioners in order to ensure that:*
 - (i) *the most efficient and effective means of education and training are provided for vocational trainees in the employment of NSW Health; and*

- (ii) *the most appropriate placement program for vocational trainees in the employment of NSW Health having regard to both the health service delivery requirements of NSW Health and the training requirements of the respective Medical College.*

Recommendation 37: *The Institute in the provision of its programs adopt the following guiding principles:*

354

- (a) *that clinical education and training should be undertaken in a multi-disciplinary environment which emphasises inter disciplinary team based patient centred care;*
- (b) *that the education and training be delivered by the most appropriate and suitable person regardless of the profession or specialty of the individual, and including, where appropriate, non-clinically trained personnel;*
- (c) *that all prevocational clinical staff enrolled in the Institute's programs be required to spend a minimum of 20% of their ordinary rostered time in Year One and a minimum of 10% of their time in Year Two participating in the training programs; and*
- (d) *that the clinical education and training program for prevocational clinical staff include at least four different components, namely:*
 - (i) *Formal teaching to which currently employed and contracted senior clinical staff would contribute;*
 - (ii) *E-learning by self-completed modules;*
 - (iii) *Simulation training conducted by senior clinical staff at simulation centres and facilities;*
 - (iv) *and Clinical skill modelling where postgraduate clinical staff are supernumerary for the relevant mandatory time to enable observation of, and modelling of, clinical skills being demonstrated by senior clinicians.*

Chapter 11 Workplace Reform recommendations

Recommendation 38: *The Chief Nurse of NSW Health should supervise the preparation within 6 months of and ensure over a 2 year period the implementation of a program across all public hospitals in NSW which is designed to achieve an improvement in the efficiency and design of nursing work practices in each ward or unit having regard to the principles of shared care and team-based work practices. The NSW program should take into account the improvements made by the Productive Ward Program in the United Kingdom and the Essentials of Care Program.*

369

Recommendation 39: *The workforce at large of NSW Health be re-aligned so as to recognise the following principles:*

378

- (a) *each member of the clinical workforce should be prepared to work within a multi-disciplinary environment as a member of, or as a contributor to an inter-disciplinary team responsible for the delivery of patient centred care;*
- (b) *patient centred care is to be provided by a team, which allocates in accordance with the principles of "shared care", a component or*

components of care to a member of the team according to their qualifications and experience;

- (c) *where a component or components of care can be provided, without adversely affecting patient care as measured by the patient care performance criteria, by*
- (i) *IT based remote support; or*
 - (ii) *by a less well, but nevertheless suitably qualified member of the team; or*
 - (iii) *by a private provider of health services,*
- then NSW Health is free to designate one of these alternatives for the provision of care.*
- (d) *a real need exists in times of a national health workforce shortage for clinical support staff to be employed to undertake tasks for which they are suitably qualified so as to allow senior clinicians, in particular, to be freed up to attend to those components of patient care which require their other skills*

Recommendation 40: *Within 12 months, NSW Health should create a position called clinical support officer within public hospitals in NSW to be filled on a needs and activity basis to undertake roles presently fulfilled by senior and junior clinical staff which can be undertaken by less, but nevertheless suitably, qualified or experienced individuals. The position will include being rostered for after hours work and on a 24 hour a day 7 days a week basis where the need is identified and where the ward activity requires, and would encompass those roles previously performed by communications clerks, ward clerks and wardsmen.*

383

Recommendation 41: *NSW Health, within 6 months, is to implement a project, the aim of which is to redesign rostering systems and practice for senior and junior doctors and senior nurses in a way which promotes safety and good quality patient care. The aim of the project must be:*

383

- (a) *To ensure the presence of an appropriate number and range of skills of these clinicians in all hospitals down to and including Peer Hospital Group Category C1 for 16 hours a day;*
- (b) *To ensure the availability of the services of these clinicians for 7 days per week; and*
- (c) *To ensure adequate coverage, whether by an on-call service or otherwise for the remaining 8 hour shift for each day.*

Chapter 12 Bullying recommendations

Recommendation 42: *In order to implement meaningful and long-lasting improvement to its workplace culture, NSW Health, as a key priority, embark immediately on a workplace culture improvement program based on "Just Culture" principles, that clearly identifies acceptable behaviours in the workplace and that is linked to NSW Health corporate values.*

421

- Recommendation 43:** *NSW Health should:* 421
- (a) *engage external expertise to develop the "Just Culture" program;*
 - (b) *ensure that all of its senior management personally champion "Just Culture" principles and regard the program as a key priority area for reform;*
 - (c) *implement a comprehensive training program for all staff and managers in "Just Culture" principles, to be completed within 3 years;*
 - (d) *introduce new procedures for the management of bullying complaints, characterised by fair and reasonable treatment of complainants and respondents, the introduction of timeframes within which complaints need to be resolved and reporting to senior management on the progress of conflict resolution processes;*
 - (e) *review existing resources for the management of bullying complaints and implement steps to ensure sufficient numbers of staff are able to handle and resolve complaints in a timely manner;*
 - (f) *formulate protocols for, and mechanisms to protect, confidentiality during investigations of bullying complaints, clearly identifying where confidentiality will not be kept (eg if a person discloses self-harm or a criminal offence); and*
 - (g) *establish a grievance advisory service to provide independent, objective advice to complainants and respondents in relation to bullying complaints.*

- Recommendation 44:** *In order to ensure the successful implementation of the "Just Culture" program, I recommend that NSW Health:* 421
- (a) *implement annual audits to monitor the performance of complaint management systems and compliance with agreed targets; and*
 - (b) *measure its success in implementation by reporting on its progress in its annual report.*

Chapter 13 Supervision of junior clinical staff recommendations

- Recommendation 45:** *NSW Health should ensure within 12 months there is developed and implemented State wide policies setting out a best practice model for the supervision of junior clinicians which:* 438
- (a) *defines supervision,*
 - (b) *defines the objectives and content of supervision,*
 - (c) *defines the supervisory relationship, including the roles and responsibilities of clinical supervisors (including consultants, registrars and nurse educators) and trainees,*
 - (d) *sets out mechanisms for resolving difficulties relating to inadequate supervision,*
 - (e) *recognises the importance of the supervisor's role;*
 - (f) *requires area health services to stipulate the roles and responsibilities of supervisors (including consultants, registrars and nurse educators) in their job descriptions (whether as employee or independent*

contractor), including the time required to be allocated to supervision duties;

- (g) requires that supervisors (consultants, registrars and nurse educators) be allocated protected time each week for carrying out active supervision of junior medical officers and nurses.

Recommendation 46: *The Institute of Clinical Education and Training, if it becomes aware of any circumstances which it considers give rise to a significant risk to patient safety or a significant risk to the provision of good quality patient care arising from any inadequacy in the supervision and training being provided at any NSW public hospital for junior clinicians, must forthwith:*

439

- (a) Notify the chief executive of the area health service or statutory health corporation together with its recommendations for the appropriate remedial actions to be taken; and
- (b) If it considers that the remedial actions, if any, which have been taken are inappropriate or inadequate to remedy the identified significant risks within an appropriate timeframe, deliver a report to the Director General of NSW Health together with recommendations for action by the Director General.

Page xvii

Recommendation 47: *Within 24 months, NSW Health should undertake a review of, and examine the improvement options for the supervision of registrars undertaking surgery, including but not limited to:*

442

- (a) Whether it is appropriate, and if so how, to separate by facility or operating list or otherwise planned surgery from emergency and urgent unplanned surgery;
- (b) Whether any change in workplace rostering or practices is necessary to maximise supervision of surgeons in training and minimise risk to patient care from surgery being conducted after hours without supervisors present;
- (c) Developing systems for monitoring the extent of and adequacy of supervision of surgery being undertaken by registrars.

Chapter 14 Clinical Records and IT recommendations

Recommendation 48: *Within 6 months, NSW Health should design and implement a system of auditing the performance of all hospitals in the compilation of patient clinical records, for compliance with NSW Health policies regarding legibility and completeness of those records.*

463

Recommendation 49: *Within 6 months, NSW Health should implement and audit compliance with a policy which specifies the obligations of the Admitting Medical Officers (AMOs) in the supervision of clinical notes relating to their patients which includes a requirement that the AMO read and initial, at regular intervals each patient's clinical notes which have been written by the junior medical officer.*

482

Recommendation 50: *NSW Health should cooperate with and support the National E-Health Transition Authority including in particular developing appropriate policies to and platforms which govern the manner of and the circumstances sufficient to permit general practitioners, specialists, allied health professionals and community health clinicians, who are located outside the hospital, to gain access to relevant parts of, and information from, the electronic medical record generated within NSW public hospitals.* 496

Recommendation 51: *Within 4 years NSW Health should complete the current information technology program including the following stages:* 501

Timing	
Stage 1: 12 months	Infrastructure
Stage 2: 18 months	Electronic medical record Patient Administration System
Stage 3: 24 months	Human Resources Information System Business information strategy Medical imaging Intensive care Hospital pharmacy system
Stage 4: 36 months	Community health system redevelopment Automated rostering Clinical Documentation Medication management
Stage 5: 48 months	State-wide roll out of the electronic health record

Recommendation 52: *A high speed broadband network should be established within 18 months securely linking all public hospitals in NSW so as to enable the provision of specialist clinical services and support via the network from metropolitan-based clinicians and hospitals to regional, rural and remote clinicians and hospitals.* 502

Chapter 15 Communication recommendations

Recommendation 53: *Within 18 months, NSW Health should introduce a mandatory policy for a form containing a checklist to be completed each time a patient is admitted as an inpatient to a hospital ward from the Emergency Department. The checklist ought require details including patient's identification, provisional diagnosis, whether or not any tests and investigations have been carried out, and whether or not the inpatient consultant has been notified of the admission and accepted the admission (with the identity of the consultant under whose care the patient is admitted and the date and time of notification recorded). This form should be completed by a junior medical officer in the Emergency Department and the same form should be used throughout the State.* 522

- Recommendation 54:** *Within 6 months, NSW Health should introduce a mandatory policy which requires that when orders for pathology tests are made, the name of the ordering doctor and contact number be clearly printed (if written) or entered (if computerised) on the pathology form. The policy should include a protocol outlining the appropriate channel of communication where (a) the relevant details are incomplete or illegible and (b) the ordering doctor is not on duty or contactable.* 525
- Recommendation 55:** *Daily multi-disciplinary ward rounds should be introduced at which accurate and complete notes are taken which are approved by the supervising doctor within a specified timeframe.* 530
- Recommendation 56:** *Within 18 months, NSW Health should ensure that each hospital designs and introduces a mandatory shift handover policy, which includes, as a minimum:* 540
- (a) a requirement that part of the handover occurs at the patient's bedside;*
 - (b) a requirement that sufficient time designated for handover is built into the rostering system;*
 - (c) a requirement for the information which is to be conveyed during handover; and*
 - (d) a requirement that a written or electronic record be made of the handover.*
- Recommendation 57:** *Recommend that the function of liaison with general practitioners be undertaken as a designated role in every public hospital in NSW, either by the creation of one or more positions to undertake the function on a full time basis or alternatively the allocation, on a part time basis of the function, to an existing position.* 547
- Recommendation 58:** *In order to ensure compliance with the NSW Health policy on the mandatory provision of discharge summaries to a general practitioner the GP Liaison Officer in each hospital is to institute a regular process of checking and auditing:* 547
- (a) the provision of a discharge summary;*
 - (b) the accuracy of and the sufficiency of the discharge summary; and*
 - (c) where appropriate, the legibility and readability of the discharge summary.*
- Recommendation 59:** *Within 24 months, NSW Health should investigate and establish a plan for the introduction of modern internet based systems (e.g. VOIP) for all communications within hospitals including portable communication devices for all appropriate clinical staff members from patients and their carers are addressed as soon as reasonably practicable.* 551

Recommendation 60: *NSW Health should encourage all hospital staff to take all reasonable measures to enhance their communication with patients including by making sure that:* 554

- (a) *patients and their carers are told who staff are and what their function is;*
- (b) *patients and their carers are kept informed of the nature and purpose of any treatment about to be delivered;*
- (c) *any questions and concerns from patients on their case are addressed as soon as is reasonably practicable.*

Recommendation 61: *On discharge from hospital unless clinically inappropriate, each patient or their carer should be provided with a document, in plain language, explaining:* 557

- (a) *what medications, if any, they are to take and the details related to those medications, including, for example, frequency, dosage and any medications which are contra-indicated;*
- (b) *what their care plan is;*
- (c) *an outline of resources available to assist them upon discharge (including contact details of patient support groups); and*
- (d) *a schedule of any follow up appointments.*

Recommendation 62: *Within 12 months, NSW Health implement a state-wide policy ensuring uniforms or vests are worn by each health professional, identifying in large print the role of the health professional. The state-wide policy should:* 567

- (a) *designate a colour to each professional role and ensure that the colour is consistently adopted;*
- (b) *include a requirement for posters to be prominently displayed throughout NSW Health facilities providing a chart to indicate which uniform or colour is assigned to which profession; and*
- (c) *NSW Health amend existing policy or develop additional policy to require the wearing of name badges (or similar, but not cards on lanyards) by each type of health professional, bearing in large print the person's name and title or role.*

Chapter 16 Safety and Quality recommendations

Recommendation 63: *NSW Health should encourage each facility to have a patient care committee which has, at least, the following features: monthly meetings; include nursing, medical, allied health and administrative staff; review all deaths in the facility; and review minutes of morbidity & mortality committee meetings and any other safety and quality committee meetings.* 602

Recommendation 64: *The improvement plan process set out by the Clinical Excellence Commission in the Quality Systems Assessment Statewide Report be implemented by all area health services within the time frames specified by the Clinical Excellence Commission.* 609

Recommendation 65: *NSW Health should review the functions, size and structure of the Quality & Safety Branch to determine if it has any functions which duplicate the work of, or else would more appropriately be undertaken by, the Clinical Excellence Commission. NSW Health needs to ensure that any duplication or unnecessary replication is eliminated with the intent that the Clinical Excellence Commission will become the body primarily responsible for safety and quality within NSW Health.* 617

Recommendation 66: *If the Clinical Excellence Commission identifies that the quality and safety processes or performance of an area health service, statutory health corporation or facility are inadequate, the Clinical Excellence Commission must:* 617

- (a) *Immediately notify the general manager of the facility, the chief executive of the area health service and the Director General of NSW Health.*
- (b) *The notification must specify:*
 - (i) *the quality and safety processes or performance which the Clinical Excellence Commission has identified as being inadequate;*
 - (ii) *what action, in the opinion of the Clinical Excellence Commission, should be taken by the facility, area health service and/or NSW Health to rectify the inadequacy;*
 - (iii) *the time frame in which the action should be taken; and*
 - (iv) *a date after which the Clinical Excellence Commission will again inspect or review the area health service, statutory health corporation or facility to monitor improvement.*
- (c) *The Clinical Excellence Commission is to inspect or review the area health service, statutory health corporation or facility after the date specified in the notification.*
- (d) *If, following the inspection or review by the Clinical Excellence Commission, the action specified in the Clinical Excellence Commission's notification has not been taken, the Clinical Excellence Commission is to notify the Minister for Health with a recommendation as to what action the Minister for Health should take.*

Recommendation 67: *Within 12 months, NSW Health is to establish a board governed statutory health corporation pursuant to s.41 of the Health Services Act 1997 known as the Clinical Innovation and Enhancement Agency.* 618

The Agency is to undertake its role according to these guidelines:

- (a) *establish new, or else incorporate within it the already existing-clinical networks, taskforces and other clinician practice groups as the operative networks by which it is to undertake its role;*
- (b) *establish within a central directorate of the Agency, a reservoir of the following skills:*
 - (i) *change management;*
 - (ii) *health economics expertise;*

- (iii) *business management; and*
 - (iv) *project design and support*
 - (v) *to be provided as necessary to the clinical networks, together with such other administration support as is appropriate, to enable the efficient functioning of the clinical networks;*
- (c) *use the existing clinical network model to involve clinicians and patient representations in continuous clinical redesign to deliver safer and better patient care.*

The Agency is to have, at least, the following principal purposes and functions:

- (a) *To identify, review and enhance or else to research and prepare standard evidence based protocols or models of care guidelines for every unexceptional surgical intervention, and the common disease or syndrome treatment modalities encountered in NSW public hospitals;*
- (b) *To investigate, identify, design, cost and recommend for implementation changes in patient care by way of enhancements or improvements in clinical practice, including the content and method of such practice, in order to ensure, on an ongoing state-wide basis, better, safer, more efficient and more cost-effective patient care;*
 - (i) *To provide advice to NSW Health, or any Area, or functional Health Service, on any matter relating to the enhancement or improvement of clinical practice.*
 - (ii) *To liaise with change managers from the private sector retained to assist in the introduction of clinical re-design at the Area, hospital and unit levels and provide the point of contact between change managers and NSW Health.*

The Agency is to report directly to the Minister for Health and the Director-General of NSW Health and is to prepare an annual report to the Minister on the progress of clinical innovation and enhancement in the public hospital sector.

Recommendation 68: *Each of the chief executives of the public health organisations is to report every six months to the Clinical Innovation and Enhancement Agency and the Director-General of NSW Health on the progress of implementation of all endorsed innovation and enhancement programs, and if any program has not been implemented the explanation for such failure.*

619

Recommendation 69: *The Clinical Excellence Commission, the Clinical Innovation and Enhancement Agency and the NSW Institute for Clinical Education and Training should jointly explore whether it would be more efficient and cost effective for their operations:*

619

- (a) *to be physically co-located;*
- (b) *to share common facilities;*
- (c) *to share corporate support functions and support staff.*

Recommendation 70: *NSW Health is to ensure that quarterly reports for each unit and each facility containing the following information:* 625

- (a) *Data regarding the IIMS reports made by the facility during the period;*
- (b) *Data regarding the IIMS reports made by the unit during the period;*
- (c) *Data comparing the IIMS data for that facility and for that unit to the performance of the rest of the NSW health system, are prepared and distributed.*

Recommendation 71: *NSW Health should develop a process which ensures that upon the finalisation of each IIMS report, the results of the IIMS report are immediately reported back, by email where possible, to the person who made the initial report and their manager. If the IIMS report takes longer than one month to finalise, a monthly report regarding progress is to be provided to the reporter of the incident and their manager until the IIMS report is finalised.* 625

Recommendation 72: *The Clinical Excellence Commission to conduct regular audits of the accuracy of the data and the appropriateness of the SAC categories applied to the various incidents by reporting clinicians.* 627

Recommendation 73: *Within 3 months, the Clinical Excellence Commission to consider and advise the Director General of NSW Health whether the involvement by the chief executive in the approval of the Root Cause Analysis process requires amendment and if so in what respects.* 632

Recommendation 74: *Within 12 months the Clinical Excellence Commission to establish searchable intranet accessible to all NSW Health staff which contains all RCAs.* 633

Recommendation 75: *Within 3 months, NSW Health is to establish a Bureau of Health Information, which has the following characteristics:* 639

- (a) *It is to be independent from and not part of the Department of Health;*
- (b) *It is to be established either as, or as a part of, a board governed statutory health corporation pursuant to s.41 of the Health Services Act 1997;*
- (c) *It is desirable that it be co-located with a research facility or else a body with expertise in the collection, analysis and use of complex data.*

Recommendation 76: *The functions of the Bureau are to include, but not be limited to,* 639

- (a) *Present routinely collected data sets:*

- (i) *Public Reporting:*

Review and develop indicators of Health System Performance for the State as a whole, each Area Health Service (including functional Health Services), hospitals and units or wards;

Produce and publish regular and timely Reports of Health System Performance data according to relevant criteria;

Provide an Annual Report on the Patient Care Performance criteria, together any other relevant performance criteria to the NSW Parliament on NSW Health;

(ii) Performance Monitoring:

Develop methods and systems for the analysis of routinely collected data;

Provide advice on the enhancement of routine data collections;

Identifying and undertaking benchmarking, reporting and feedback systems for all levels of NSW Health.

(iii) Data Access and Supply:

Analysing routinely collected data in response to user requests;

Developing and distributing tools to allow users to interrogate routinely collected data (e.g. data cubes).

(iv) Value-Added Analysis:

Undertaking analysis of routinely collected data sets to explore and report on specific issues.

(b) New data sets:

(i) Evaluation:

Undertaking, commissioning or advising upon the meaning of the cost and effectiveness of new policies and programs.

(ii) Research:

Commissioning research, as appropriate to support and renew its own functions;

Commissioning research into areas and issues, identified by or to it, concerning health system performance;

Commissioning or undertaking research for the developing of new analytic methods for both routinely collected data sets or else new data sets.

Recommendation 77: *Within 6 months, the Bureau of Health Information is to develop and publish patient care performance criteria which are adequate to enable measurement on a continuous basis of the performance in the provision of care to patients of each unit or ward, hospital, area (or functional) health service and NSW Health as a whole in the following areas:*

(a) Access: Access to and availability of hospital services including timeliness of the provision of services and proximity to patient's home or locality. Availability of alternative community or home based services in lieu of the hospital services;

- (b) *Clinical: Clinical performance including patient outcome, appropriateness of clinical treatment method, the variation, if any, from protocols and models of care, and identified benefits or detriments to the health and wellbeing of the patient;*
- (c) *Safety and Quality: Safety and quality of the clinical care and the hospital attendance or admission.*
- (d) *Cost: Cost of the clinical care including re-presentation or re-admission cost, and error cost (including provision of additional care, medication, diagnostic tests and/or counselling services and any financial settlement including litigation costs);*
- (e) *Patient: Patient experience and satisfaction;*
- (f) *Staff: Staff experience and satisfaction;*
- (g) *Sustainability: System impact and sustainability.*

Recommendation 78: *Within 12 months, the Bureau of Health Information is to start publishing quarterly reports, within 60 days of the end of the reporting period, which disclose the performance of each unit or ward, hospital, area (or functional) health service and NSW Health as a whole by reference to the patient care performance criteria.* 640

Recommendation 79: *Within 24 months, NSW Health is to review whether it is either necessary or appropriate to continue to measure hospital performance by the current key performance indicators or whether such measurement ought to be discontinued having regard to the quarterly reports of the Bureau of Health Information.* 641

Chapter 17 Key performance indicators recommendations

Recommendation 80: *NSW Health, if it has not fully implemented the next recommendation, should within 18 months provide either by consensual arrangement or changed technology that ambulance officers and the Emergency Department agree and determine jointly off stretcher time.* 656

Recommendation 81: *Within 18 months, the practice whereby ambulance officers remain with patients in the Emergency Department of hospitals until the patient has their definitive treatment commenced ought to be abolished.* 657

Recommendation 82: *NSW Health should institute an audit program of waiting lists kept for each hospital in NSW, conducted by staff who are not associated with the relevant area health service or the hospital. The audits should examine all paperwork that the hospital is required to maintain for the waiting lists including correspondence with referring doctor, and should include the auditing of any reclassification of patients' clinical urgency category.* 659

Recommendation 83: *Any hospital which reclassifies the clinical urgency of a patient whose name is on, or is to be entered on, a surgical waiting list, is to inform the patient's referring doctor in writing within 7 days.* 660

- Recommendation 84:** *Within 12 months NSW Health should critically review this requirement for reporting against Key Performance Indicators required of Emergency Departments to determine whether:* 666
- (a) *The indicators are useful;*
 - (b) *The indicators are necessary; and*
 - (c) *Whether any undue burden is being imposed on Emergency Department staff by the existing regulatory requirements.*

Chapter 18 Hospital acquired infection recommendations

- Recommendation 85:** *NSW Health refund patients the net cost (if any) for medication necessary for the treatment of hospital acquired infection after discharge of the patient from the hospital.* 675

- Recommendation 86:** *The extent of hospital cleaning services be reviewed within 12 months so as to ensure that properly trained cleaners are available, at least:* 677

- (a) *In the principal referral group A and B hospitals and paediatric specialist hospitals on a 24 hour a day, 7 days a week basis*
- (b) *In major metropolitan and non-metropolitan hospitals, on a permanent 16 hour a day, 7 days a week basis and on call at other times.*

- Recommendation 87:** *I recommend that the Clinical Excellence Commission within 9 months, undertake a review of the evidence which exists about the appropriateness of a policy such as the “Bare Below the Elbows Policy” and develop a policy capable of ready implementation and evaluation about the appropriate clothing and accoutrements which ought be worn by health care workers when engaged in clinical care in public hospitals in NSW.* 682

- Recommendation 88:** *Within 6 months, NSW Health develop a new policy which outlines an enforcement regime which includes the following as a minimum, for failing to comply with hand hygiene protocols for all staff who come into contact with patients.* 690

- (a) *Where the failure is unintentional:*
 - (i) *First occasion Counselling*
 - (ii) *Second occasion Completion of an online educational package*
 - (iii) *Third occasion Attendance at a public education lecture with other ‘non-compliers’ and a warning that any further failure will result in formal disciplinary action*
 - (iv) *Fourth occasion Disciplinary action*
- (b) *Where the failure is intentional or reckless, immediate disciplinary action is called for which may include, depending upon the seriousness of the conduct, counselling, supervision, or other disciplinary action including dismissal. 688*
- (c) *It should be mandatory for a Chief Executive to report professional staff including VMOs, to their relevant registration authority for*

unsatisfactory professional conduct in all cases where a failure has occurred on four occasions or else is intentional or reckless.

Compliance with the hand hygiene should become part of the contractual obligations of all health care workers.

An intentional or reckless failure to comply with hand hygiene precautions should be reported on IIMS and regarded, at a minimum, as a SAC 2 category incident.

Recommendation 89: *NSW Health ought mandate the screening of vulnerable and high risk patients by standard or rapid screening technology for MRSA and all other significant pathogens across all area health services in the case of planned admissions BEFORE and for all other cases IMMEDIATELY AFTER entry into the hospital. Such mandatory screening ought to commence as soon as practicable but ought be fully operational within 12 months.*

693

Recommendation 90: *NSW Health to consider PD2007-084 and if appropriate, to rewrite it, to include material about and requirements for infection prevention which needs to include as a minimum, the following:*

694

- (a) each ward must undergo regular audits (at least monthly) and random audits. The audits should be undertaken by an infection control professional who is not part of the staff of the ward;*
- (b) each ward must nominate either the nurse unit manager or in the alternative, an appropriate infection control officer whose tasks include education about infection control, enforcement of infection control standards, displaying leadership in the ward by their example and undertaking audits of performance in other wards or hospitals;*
- (c) each ward must publicly display statistics and results compiled monthly and updated throughout the year showing, at least:
 - (i) the rate of hospital acquired infection per patient on the ward;*
 - (ii) the rate of compliance with hand washing techniques (and any other applicable hygiene techniques) separately for each group of health care workers caring for patients.**

Chapter 19 Deteriorating patients recommendations

Recommendation 91: *Within 12 months, NSW Health is to implement a system in accordance with the recommendations of the Clinical Excellence Commission for the detention of deteriorating patients containing the following elements:*

712

- a system for early identification of an at-risk patient in every hospital in NSW (this system will involve the implementation of a specifically designed vital signs/observation chart);*
- escalation protocols to manage deteriorating patients, which would include a rapid response system;*
- development and implementation of detailed education and training programs, aimed at recognising and managing the deteriorating patient;*
- the ongoing collection and analysis of appropriate data to monitor the implementation and progress of the program;*

- a standardised process for the handover of patients which can be utilised on all occasions and can equally be done when all clinicians are not on site together;
- high level support from management and clinicians; and
- ongoing evaluation.

Chapter 20 Emergency Department recommendations

Recommendation 92: *NSW Health devise ways of ensuring that adequate and clear information is provided to all patients who attend at the Emergency Department.* 718

Recommendation 93: *Within 12 months, the role of the Clinical Initiatives Nurse should be introduced, if not already in existence, in the waiting room of Emergency Departments in all metropolitan areas and in major regional cities.* 722

Recommendation 94: *Triage should be carried out by a senior experienced registered nurse with emergency or critical care experience whenever possible and, without exception, in all tertiary hospitals, and in all like hospitals.* 725

Recommendation 95: *Within 18 months, each hospital within a peer group down to and including B2 – Major Non-Metropolitan Hospital and which operates an Emergency Department, ought also to establish a Medical Assessment Unit where enrolled chronic and complex patients will be assessed prior to admission.* 735

Recommendation 96: *Within 6 months, every hospital should adopt a policy which permits, subject to the conditions described above, the practice that where a patient is to be admitted to a hospital from an Emergency Department or else a Primary Care Centre, the determination of the ward to which the patient is to be admitted rests with the medical officer in charge of the Emergency Department or the Primary Care Centre, as the case may be, and not with the medical officer (or ward staff) of the department to which the patient is to be admitted.* 742

Recommendation 97: *All hospitals review their policies and work practices which affect patient discharge to ensure as far as practicable that the time and date of discharge is activated:* 746

- At the earliest possible opportunity; and*
- In a way which is consistently with good patient care, maximises bed availability*

Recommendation 98: *The principles by which Emergency Departments should operate include, but are not limited to:* 753

- That the provision of emergency care is to be determined by clinical condition, and is not one based on, or determined by, patient demand;*
- A recognition that the performance of Emergency Departments is inextricably linked with the performance of the whole of the hospital;*

- (c) *An acceptance that Emergency Departments are not the necessarily the only portal for an unplanned admission to hospital.*

Recommendation 99: *Within 18 months, Emergency Departments, so designated, ought be limited to providing care for only those in need of immediate or emergency care which requires the services of highly skilled emergency teams led by specialist emergency physicians. This will ordinarily include those presently in categories 1, 2 and 3 of the Australian Triage Scale, but not those ordinarily within categories 4 and 5.* 754

Recommendation 100: *Such patient care performance criteria as measure the timeliness of access to services in Emergency Departments do so by reference to only two categories namely the provision of immediate care (which is the existing category one of the Australasian Triage Scale) and a second category of emergency care (which combines the existing categories 2 and 3 of the Australian Triage Scale) being care which needs to be provided within a maximum of 30 minutes. The benchmark for both of these categories should be 100%.* 754

Recommendation 101: *Within 18 months, where a hospital has an Emergency Departments, it should establish a Primary Care Centre which would provide services for all patients who attend the hospital seeking urgent or unplanned care and who are not determined clinically to be in need of immediate or emergency care.* 754

Recommendation 102: *The current framework of collaboration between NSW Health and the Emergency Department Workforce Reference Group be continued in order to, by consensus:* 760

- (a) *Identify and publish current staffing levels and profiles for each existing Emergency Department;*
- (b) *A workload tool for determining appropriate staffing levels for Emergency Departments;*
- (c) *A plan identifying the appropriate number and location of emergency medicine trainees which ought be funded by NSW Health.*

Recommendation 103: *A clinical support officer be rostered for duty as a communications officer for no less than 16 hours per day at every Emergency Department.* 762

Chapter 21 Community Health recommendations

Recommendation 104: *NSW Health should articulate the goals of its out of hospital programs and make this information as well as information about how each program operates or what they are intended to achieve publicly available.* 784

Recommendation 105: *NSW Health should ensure that community health services are available as far as practicable on weekends and after-hours to facilitate discharge, improve the efficiency of the acute care system and patient care in both the hospital and community settings.* 784

Recommendation 106: *NSW Health within 18 months is to review and determine the most effective and appropriate structure for the governance in each area health service of the staff and programs delivering health services in the community.* 788

Chapter 22 Mental Health recommendations

Recommendation 107: *Within 18 months, each hospital which operates an Emergency Department should establish a safe assessment room at a location, if not adjacent to, then proximate to the Emergency Department.* 807

Recommendation 108: *Within 18 months, each hospital which does not have a psychiatric emergency care centre (PECC) within a peer group down to and including B2 – Major Non-Metropolitan Hospital and which operates an Emergency Department, ought also to establish a psychiatric emergency care centre (PECC) at a location, if not adjacent to, then proximate to the Emergency Department unless there is easy access to a PECC located at another hospital within a reasonable transfer distance.* 810

Recommendation 109: *Mental health patients re-presenting to a mental health inpatient facility or psychiatric emergency care centre (PECC) be admitted to that facility without prior admission to emergency unless, in the opinion of a triage nurse or medical officer in emergency, that person requires specialist emergency medical care.* 810

Chapter 23 Surgery recommendations

Recommendation 110: *NSW Health, within 18 months, should ensure that there is implemented in each area health service for hospitals down to and including Category B2, Major Non-Metropolitan, a model of care for surgery which includes where possible and appropriate:* 844

- (a) *The separation by facility, or operating list or otherwise, of planned or elective surgery from emergency or urgent unplanned surgery;*
- (b) *The introduction of an Acute Surgery Unit, which is a consultant led unit, the purpose of which is to undertake all acute surgery at the hospital within the 12 hour day time period;*
- (c) *Explores the availability for, and the engagement of smaller hospitals to provide the facilities for surgery to be undertaken there to supplement the principal surgery programs;*
- (d) *Enables improvements to supervision of the kind referred to in Chapter 13.*

Chapter 24 Pathology & Medical Imaging recommendations

Recommendation 111: *NSW Health provide its hospitals with the tools to analyse requests for tests, so that the heads of medical departments can track the number and cost of tests by patient and health professional, and regularly publish the results within the hospital for all departments.* 860

Recommendation 112: *That the Department of Environment and Climate Change amend the conditions for licences under the Radiation Control Act*

1990 to include the requirement for a quality audit of remote operators who hold licences under the Act to perform x-ray radiology services. 863

Recommendation 113: *Within 18 months, every public hospital in NSW ought be fitted with a digital radiological imaging system, such as PACS, or a compatible system thereto, which will enable the electronic transmission of medical images to remote locations for use in clinical treatment, reading and interpretation.* 871

Recommendation 114: *NSW Health establish a central radiology service sufficiently staffed to read the results of medical images and provide medical imaging reports to public hospitals across NSW 24 hours a day, 7 days a week. In establishing this service, NSW Health should compare the costs of providing this service itself or outsourcing it to the private sector. In the event that it may be able to be provided by the private sector more cost effectively, NSW Health should consider seeking tenders for this service.* 871

Chapter 25 Funding recommendations

Recommendation 115: *The resource distribution formula should be expanded to include mental health services. The area health services should be funded for these services according to their calculated entitlement under the resource distribution formula.* 903

Chapter 26 Hospitals recommendations

Recommendation 116: *By 1 July 2009, NSW Health is to designate and resource only three Major Trauma Centres in the Sydney metropolitan area and one Major Trauma Centre for rural NSW which is to be located in Newcastle.* 943

Recommendation 117: *In my view, there needs to be a complete state-wide review undertaken by NSW Health which involves:* 947

- (a) *the identification of a set of criteria, which relate to at least, patient safety, necessary workforce skills, the volume and quality of services regarded as an appropriate critical mass for the services provided across NSW in public hospitals;*
- (b) *a determination of whether each hospital, having regard to its location, the available workforce determined on a long term basis, the size of the population which it services, the alternative locations within an appropriate distance (measured by time or distance) and the age and state of repair of the facilities and equipment, is (or can become) a location for the delivery of safe patient care;*
- (c) *a clear delineation of the role of each hospital – what it can and can't do;*
- (d) *clear communication of the role of a local hospital to its community, and community understanding of the limitations of the local hospital;*
- (e) *re-allocation of specialist medical services to hospitals in NSW best placed to deliver those services; and*

- (f) *the consideration of the availability of an efficient transport and retrieval system state-wide to transport patients to the hospital best placed to provide the medical service required, and return the patient to their original locations.*

Chapter 27 Transport recommendations

Recommendation 118: *Extend the number of paramedics who are qualified and trained as extended care paramedics and who are also qualified and trained to make non-transport decisions in accordance with the relevant protocols of care.* 966

Recommendation 119: *The patient override function in the Matrix used by the NSW Ambulance Service should be abolished.* 969

Recommendation 120: *Paramedics in regional, rural and remote locations ought receive additional training so as to enable them to assist in the provision of immediate or emergency care delivered at the regional, rural or remote hospitals.* 971

Recommendation 121: *In regional, rural and remote areas, it is desirable that ambulance stations be co-located with the principal hospital facility of the city or town.* 972

Recommendation 122: *NSW Health should develop a role description for an introduce a new category of staff member in the NSW Ambulance Service whose task would be principally to do all non-treatment duties which presently a two person team attends to, such as driving and attending to radio transmissions and paperwork.* 972

Recommendation 123: *NSW Health is to ensure that there is provided, separately from the emergency transport service of NSW Ambulance, a non urgent transport service which is responsible for:* 977

- (a) *The return transport of rural patients from metropolitan or rural referral hospitals to either their hospital of origin or their home depending upon their clinical condition;*
- (b) *The transport of metropolitan patients between hospitals or from hospitals to aged care facilities; and*
- (c) *Any other transport required to enable timely investigation and treatment of patients where their clinical condition necessitates access to specialised transport.*

Chapter 28 Beds recommendations

Recommendation 124: *The policy which authorises, and the practice which gives effect to, using inpatient wards (except Intensive Care Units, High Dependency Units and Emergency Departments) to house both men and women in the same room, or separate ward space ought to cease forthwith.* 992

Recommendation 125: *NSW Health should commission a research project, the purpose of which is to establish what levels of risk and safety accompany varying levels of bed occupancy within a hospital facility, in order to determine a desirable bed occupancy level for NSW public hospitals.* 994

Recommendation 126: *Within 18 months, NSW Health should ensure that area health services provide to clinicians every 6 months information about their patients' lengths of stay and comparable data with their colleagues in the hospital.* 1000

Chapter 29 Food recommendations

Recommendation 127: *Within 12 months, NSW Health should design and implement a policy which delineates clearly the respective responsibilities of Health Support Service staff, nursing and allied health staff (including clinical dietitians) with respect to all of the tasks associated with ordering and service of food to patients and consumption of food by patients, including monitoring an adequate food and drink intake by the patient.* 1017

Recommendation 128: *Health Support Services prepare (or have a consultant prepare for them) specifications for the packaging and containers (including covers and seals) used on hospital food, so that the packaging and the containers:* 1018

- (a) *comply with food standards; and*
- (b) *are able to be opened by frail, aged or unwell patients.*

Chapter 30 Buildings & Equipment recommendations

Recommendation 129: *Within 24 months, NSW Health should establish a central State-wide equipment asset register recording details of fixed assets with an acquisition value greater than \$10,000 and attractive assets greater than \$1,000. Details recorded in the register should, as a minimum, include:* 1031

- (a) *the purchase price;*
- (b) *the date of acquisition;*
- (c) *the estimated life expectancy (usability) or contract expiry date;*
- (d) *the half-life usability assessment date; and*
- (e) *the location of the asset.*

Recommendation 130: *NSW Health should ensure that each hospital performs equipment functionality assessments every 6 months to assess and predict the need for equipment replacement.* 1033

Chapter 31 Administration & Management recommendations

- Recommendation 131:** *NSW Health is to explore, in collaboration with the Health Care Advisory Council the implementation of a charter which enables community participation in the affairs of hospitals. The charter should:* 1057
- (a) *Identify those committees, which would be appropriate for and which would benefit from, having community representation;*
 - (b) *Identify whether in respect of any representation, any particular qualification, skill or experience would be desirable; and*
 - (c) *Determining how the selection or appointment ought take place.*
- Recommendation 132:** *Referral patterns should be made by clinicians on the basis of finding the appropriate clinical setting for the patient's treatment. If there is more than one setting, then the treatment ought to be undertaken at the nearest appropriate facility. If that is within area health service boundaries, then that should be used where possible. If not possible, then one out of the area health service boundary should be accessed. Funding should follow the patient.* 1057
- Recommendation 133:** *A member of the Area Health Advisory Council, nominated by the chair of that Council, be entitled to attend and be present at meetings of the principal executive committee of the Area.* 1069
- Recommendation 134:** *I recommend that, but for the institution of NSW Kids, there be no other alterations to the current area health service governance structure.* 1095
- Recommendation 135:** *I do not recommend that there be reinstated boards of directors whose task it is to govern the various area health services as board governed health corporations within the meaning of the Health Services Act 1997.* 1095
- Recommendation 136:** *In order to improve governance, no later than 1 July 2009, the following changes take place within area health services and functional health authorities:* 1095
- (a) *that the Chief Executive be required to publish to all staff no later than four weeks after the delivery of the NSW State budget, the details of the budget for the entire health service, for each hospital and for each ward, unit or separate component part within the hospital;*
 - (b) *the Chief Executive institute procedures for, and publish guidelines which describe the matching of responsibility for delivering of patient care performance, the accountability for that performance and the authority, within proper budgetary constraints, to take any steps necessary to achieve the high standards of performance.*
 - (c) *that the Chief Executive publish to all staff on a monthly basis, the patient care performance status of each of the units or wards, hospitals and the entire area, in accordance with the criteria earlier recommended.*

Recommendation 137: *Within 3 months, NSW Health is to create within each area health service, a position entitled “Executive Clinical Director” which would be occupied by a qualified medical practitioner. That position would include, but not be limited to, the following functions:*

1095

- (a) *the provision of independent advice on all matters relating to clinical practice directly to the Chief Executive of the area health service or functional health authority;*
- (b) *the provision of independent advice on any matter relating to the medical workforce directly to the Chief Executive of the area health service or functional health authority;*
- (c) *provide oversight of, to be responsible for, and to champion enhancements to ongoing clinical practice, clinical practice improvement and safety and quality improvement programs;*
- (d) *act as the public spokesperson, where required, for the area health service on all matters relating to clinical practice, and the safety and quality of patient care in the facilities in the Area;*
- (e) *conduct regular forums (or similar consultation processes) with all clinicians, including with Medical Staff Councils, to ensure that clinicians are kept aware of all health systems and clinical practice improvements and enhancements and to enable clinicians to provide timely feedback to the Area on such matters.*

Page xxxv

Recommendation 138: *Within 18 months, NSW Health is to design and introduce a defined career path and structure for senior clinical leadership, and for senior clinician participation in senior administration and management roles.*

1096

Recommendation 139: *NSW Health examine how health services, which are regulated by State legislation, including mental health and like legislation, can best be delivered so as to ensure the efficiency and quality of patient care between differing legislative regimes in different but adjoining States and Territories.*

1097

1 What led to this Inquiry and how it was done

Background to this Inquiry	2
Jana Horska	2
Public concern	3
Inquiries already undertaken	4
Vanessa Anderson	6
Establishment of this Inquiry	7
Terms of reference	7
Systemic & institutional issues	7
Conduct of this Inquiry	8
Written submissions	8
Hospital visits.....	8
Hearings	8
Meetings	9
Expert panels.....	9
Special Investigations.....	9
Summons	9
Feedback forums.....	10
Scope of this Inquiry	10
Acute care services	10
Models of care	11
Structure of my report	12
Patients.....	12
Workforce	12
Communication.....	13
Patient safety.....	14
Areas of medical treatment.....	14
Practical components	14
Ensuring change.....	14

Background to this Inquiry

Jana Horska

- 1.1 On Tuesday evening, 25 September 2007, Jana Horska arrived at the Emergency Department at Royal North Shore Hospital with her husband Mark Dreyer. Ms Horska was 14 weeks pregnant, and experiencing symptoms that she may miscarry. Ms Horska was assessed by the triage nurse as being Category 4, that is, a patient with a potentially serious condition, to be treated within one hour. Ms Horska was asked to wait.¹
- 1.2 The level of activity in the Emergency Department that night was extremely high:
 - (a) a number of patients had been assessed as requiring more urgent attention than Ms Horska;
 - (b) all 26 beds in the Emergency Department were in use, including 3 resuscitation bays;²
 - (c) about half of the beds in the Emergency Department were occupied by patients who had already been admitted to Royal North Shore Hospital but were awaiting a bed in a ward - 7 of these patients had been waiting for more than 8 hours, an experience called "access block";³ and
 - (d) there was a small shortfall in nursing staff.⁴
- 1.3 This combination of events was not uncommon. NSW Health has provided me with data that confirms the statements above. In particular it has provided information that indicates that:
 - (a) there were 51 patients present in the Emergency Department at the time Ms Horska was triaged at 7:11pm on the night of 25 September 2007. 26 were receiving active treatment, 12 were awaiting an inpatient bed, 9 were waiting to be seen (including Ms Horska), 3 were waiting to depart and 1 was awaiting transfer to another hospital;⁵
 - (b) of the patients waiting to be seen at 7:11pm, 4 were assessed as being in a higher triage category than Ms Horska;⁶
 - (c) 3 patients who were waiting to be seen were assessed as being in the same triage category as Ms Horska. 2 of those patients had been waiting longer than the 1 hour benchmark;⁷
 - (d) at 9:00 pm that evening there were 16 admitted patients in the Emergency Department who were awaiting an inpatient bed;⁸
 - (e) of the 15 nursing staff who were rostered to work in the Emergency Department on the afternoon shift, one was on sick leave and unable to be replaced.⁹
- 1.4 Ms Horska did not receive medical treatment within an hour. After 2 hours of acute pain, Ms Horska miscarried in a hospital toilet in distressing circumstances.

Public concern

- 1.5 Ms Horska's experience received widespread media coverage which included accounts, often harrowing, of other similar events.¹⁰ The reports initiated a wide-ranging discussion in the media regarding the public's fears about access to treatment at hospitals, and the dissatisfaction of doctors and nurses with the system in which they had to provide care.

Staff morale at an all-time low: senior nurse

State of emergency grips cash-starved hospitals

More beds, more staff
the key, doctors say

**Nurses juggle lives
on a 17-hour shift**

**Leading
doctor
slams
system**

Page 3

- 1.6 Nurses and doctors from a range of hospitals came forward, pointing to a chronic lack of funding, staffing and beds.¹¹ Nurses spoke of low wages, high responsibilities for patients, long shifts and poor staff relations.¹² These factors were said to contribute to low morale and patient complaints of a lack of compassion shown by tired staff.¹³
- 1.7 Emergency Department doctors spoke of dirty facilities, a lack of staff and resources, and a disconnect between medical staff and hospital administration.¹⁴ Senior doctors expressed concern that Emergency Departments were largely staffed by junior and inexperienced locum doctors, routinely having to make life or death decisions without supervision.¹⁵
- 1.8 One in 5 jobs in Emergency Departments were said to be vacant, or 37% of positions if hospitals were staffed at the safe level recommended by the Australian Medical Workforce Advisory Committee.¹⁶
- 1.9 Ambulance officers came forward saying that they were waiting for hours with patients at blocked Emergency Departments before beds became available, leaving no ambulances to respond to urgent calls elsewhere in the city.¹⁷

Crowded hospitals in danger zone

Patients forced to wait in streets

No way to treat Gran

**91-year-old
dumped in
storeroom**

- 1.10 Parents told of lengthy delays before their young children were seen at Emergency Departments for serious injuries.¹⁸ Patients were found accommodated in storage rooms, with no access to an emergency buzzer for 24 hours and out of sight of nurses, as Emergency Departments were over-full. These included 91 year old Edith King.¹⁹
- 1.11 Concerns were expressed beyond the doors of Emergency Departments. Families of patients told of paying for private nurses to attend to their loved ones in public hospitals, or attended to nursing duties themselves, as the nurses were too stretched to look after the patients adequately.²⁰
- 1.12 Doctors described an “absolute dog’s breakfast” in respect of aged care services and called for better co-ordination between GPs, public hospitals and aged care facilities to prevent elderly patients clogging up ward beds.²¹
- 1.13 Surgeons complained of delays to urgent surgery, due to a lack of staff and intensive care beds.²²
- 1.14 Bed occupancy levels at hospitals were said to be over the safe levels of 85%, being closer to 97%. This was described as the “danger zone”,²³ leading to increased mortality.²⁴



Inquiries already undertaken

- 1.15 Two inquiries have already been undertaken in relation to Ms Horska’s experience and Royal North Shore Hospital more generally.

Professors Hughes & Walter’s Inquiry into the Care of a Patient with Threatened Miscarriage at Royal North Shore Hospital on 25 September 2007

- 1.16 In September and October 2007, Professors Clifford Hughes and William Walters investigated Ms Horska’s care at Royal North Shore Hospital and recommended a new protocol for treatment of women presenting at Emergency Departments with threatened miscarriages.
- 1.17 I am told by NSW Health that significant changes have been made as a result of the report of Professors Hughes and Walters.

- Women who arrive at hospital displaying signs of a complication in early pregnancy, and whose condition is assessed as unstable, are now placed in a higher triage category, which means that they will get higher priority and be seen by a doctor more quickly.²⁵
- New Early Pregnancy Units have been established and existing Early Pregnancy Units have been upgraded.²⁶ (Early Pregnancy Units are staffed by registered nurses. Women whose condition is considered stable may be transferred to an Early Pregnancy Unit for further assessment and referral to a specialist, if required.)
- The Early Pregnancy Assessment Service has been expanded in major metropolitan hospitals and major rural hospitals.²⁷ (A woman displaying signs of complications in early pregnancy may be referred to an Early Pregnancy Assessment Service for scanning, diagnosis and management of her condition.) Additional funding has been provided to this service to increase the number of social workers available for women with early pregnancy complications.²⁸
- Funding has also been provided to establish or enhance public antenatal services in rural and remote communities through the Shared Pregnancy Care program.²⁹ This program allows women to access midwife care in consultation with their GP.

- 1.18 Professors Hughes and Walters also made some useful suggestions as to how the Emergency Department at Royal North Shore Hospital should be changed to improve the experience of patients: changes to the physical environment of the 'waiting room', improvements in communication skills of frontline triage nurses and the provision of written information to patients on how Emergency Departments work. Whilst these recommendations were treated sceptically by the some doctors,³⁰ I think the suggestions have much to commend them across all Emergency Departments and I will discuss these suggestions further in Chapter 20.

NSW Parliamentary Inquiry

- 1.19 In October 2007, a Joint Select Committee was established by the NSW Parliament to inquire into the operation of Royal North Shore Hospital generally. Public hearings were held, and the inquiry heard evidence of overworked doctors and nurses, a lack of continuity of patient care, a lack of information sharing with patients and their families, a lack of diagnostic capacity out of hours, poor complaints handling and a lack of cleanliness.³¹
- 1.20 In December 2007, the Joint Select Committee reported on the quality of care at Royal North Shore Hospital for patients, and measures to improve it. The Joint Select Committee identified significant problems concerning the management and operation of Royal North Shore Hospital and made 45 recommendations, many relevant to public hospitals across the state. The committee made recommendations in respect of the operation of the Emergency Department as well as the operation of the hospital generally in terms of workplace culture, workforce, management, funding, information technology and incident and complaint management.³²
- 1.21 In February 2008 the Government responded to each of the Joint Select Committee's recommendations.³³ Of the 45 recommendations made by the Joint Select Committee, the Government supported or supported in principle 43 recommendations. It outlined the action taken to address each issue raised by the recommendations or alternatively how it planned to address them.³⁴

Vanessa Anderson

- 1.22 On 24 January 2008, the NSW Deputy State Coroner Mr Milovanovich reported on the death of Vanessa Anderson³⁵, a 16 year old girl who died at Royal North Shore Hospital after being admitted with a head injury inflicted by a golf ball.
- 1.23 The coroner's report makes heart-breaking reading. In short, there was poor communication between doctors, staffing inadequacies, no or inadequate medical notes, poor clinical decisions, ignorance of protocols and incorrect decisions by nursing staff. The coroner concluded that Vanessa died from respiratory arrest due to the depressant effect of opiate medication. The coroner lamented that, in Vanessa's case, almost every conceivable error or omission occurred and continued to build on top of one another, leading to Vanessa's death.
- 1.24 The coroner observed:³⁶
- "There is little doubt that the NSW Health system, while certainly staffed by dedicated professionals is labouring under increased demands and expectations from the general public. ... Unfortunately, the same issues are invariably identified: not enough doctors, not enough nurses, inexperienced staff, poor communication, poor record keeping and poor management. These are systemic problems that have existed for a number of years and regrettably they all surface in the death of Vanessa Anderson. ... it is almost impossible to avoid comment on the unfortunate repetition of the same systemic problems that continue to surface. ... the government of the day has the responsibility to provide adequate resources, training and staff to ensure the delivery of appropriate and timely medical services.
- ... It may be timely that the Department of Health and or the responsible Minister consider a full and open Inquiry into the delivery of health services in NSW."
- 1.25 On the same day, the establishment of this Inquiry was announced by the then Premier of NSW, Mr Morris Iemma MP.
- 1.26 Vanessa Anderson's father responded to the announcement of this Inquiry by saying, "From this moment on, Vanessa Anderson's ordeal, and the fact of what we've been through, will have meaning."³⁷ I certainly hope that the work which my Inquiry has undertaken, and the recommendations made, go some small way to making that so.



Establishment of this Inquiry

- 1.27 On 29 January 2008, Her Excellency Professor Marie Bashir AC CVO, Governor of NSW, issued Letters Patent appointing me under the *Special Commissions of Inquiry Act 1983* to inquire into and report on the delivery of acute care services in public hospitals in this state.

Terms of reference

- 1.28 A copy of my terms of reference is at **Appendix 1**. The terms of reference are broadly phrased and encompass two very large tasks.
- 1.29 First, I am to inquire into systemic and institutional issues in the delivery of acute care services in NSW public hospitals raised in submissions I receive, and recommend changes to address those issues.
- 1.30 Second, I am to identify models of patient care used in the delivery of acute care services in NSW public hospitals, with particular regard to case management including supervision of junior clinical staff, clinical note-taking and record-keeping, and communication between health professionals involved in the care of a patient. Further, I am required to:
- (a) recommend changes to these models of patient care to improve the quality and safety of patient care,
 - (b) identify any systemic impediments to the implementation of these changes,
 - (c) recommend changes to overcome these impediments; and
 - (d) recommend changes to workforce policies and practices to support improved models of patient care.
- 1.31 Finally, it should be noted that under the terms of reference:
- (a) I was required to refer individual patient complaints to the Health Care Complaints Commission. I referred 213 such complaints.
 - (b) In addition to the usual powers conferred on a Commissioner by the *Special Commissions of Inquiry Act 1983* to hold public and private hearings and issue summons to witnesses and for the production of documents, I was also given most of the powers of a Royal Commissioner.³⁸ I found these powers ample to discharge the terms of reference.

Systemic & institutional issues

- 1.32 After a review of the submissions received by this Inquiry, together with my assessment of comments made at informal visits and public and private hearings, I have identified a significant number of systemic and institutional issues in the delivery of acute care services in NSW public hospitals which merit being dealt with in my Report. Many more issues were raised with me by health care professionals and members of the public. Some of these fell outside my terms of reference and so it would not be open to me to investigate them. Others seemed to raise individual rather than systemic issues and I deemed them to be inappropriate to investigate. Some readers of this report will be disappointed that the matters raised with me during evidence and by submissions are not dealt with. However, for many reasons, including those to which I have referred, it was not possible during this Inquiry to deal with every issue raised with me.

- 1.33 My Report comprises 3 volumes in which I attempt to deal comprehensively but succinctly with the many systemic and institutional issues which have arisen. I am disappointed by the length and detail of my Report but I do not regret that because the Terms of Reference, require, and the public expects, my Report will be thorough.
- 1.34 I have also prepared a single volume overview of my Report which attempts to highlight the principal issues and capture my views, about those issues. Readers may find that a useful, and somewhat shorter way to understand my views about acute care services in NSW Public hospitals.

Conduct of this Inquiry

- 1.35 The terms of reference are broad in scope and required an immense effort within a relatively short timeframe.

Written submissions

- 1.36 On 7 February 2008, I called for submissions through advertisements in major metropolitan and regional newspapers. My staff also wrote to 95 organizations who appeared to me to have an interest in the terms of reference. In total, I received over 1,200 submissions from 900 organisations and individuals. A list of the written submissions, other than those which the author requested be treated confidentially, is at **Appendix 2**.

Hospital visits

- 1.37 From 14 February 2008, my staff and I informally visited 61 public hospitals and facilities throughout NSW, a complete list of which is at **Appendix 3**. The purpose of these visits was to familiarize myself with the facilities available to staff, the conditions under which they work, and to discuss informally with staff the problems being experienced and possible solutions.
- 1.38 These visits were arranged on short notice to the hospital concerned, in an effort to get an accurate 'snapshot view', and this was I think successful. I found all staff, whether clinical or administrative, were forthcoming, frank, usually committed and, generally, very impressive.

Hearings

- 1.39 On 14 February 2008, I held an opening day for this inquiry. From 10 March to 26 May 2008, I conducted 39 public hearings at, or near, public hospitals.
- 1.40 People were able to give evidence at these hearings:
- (a) in public, or
 - (b) in private, if I was satisfied that that was desirable given the confidential nature of any evidence or for any other reason.
- 1.41 Some further hearings were held at the Inquiry's offices, including by video link, to take the evidence of witnesses who were not able to be accommodated in the time available at particular hospitals.

- 1.42 This Inquiry heard from a total of 500 witnesses in the public hearings, and a further 128 witnesses gave evidence in private. A complete list of public hearings, together with the witnesses who gave evidence in public, is at **Appendix 4**.

Meetings

- 1.43 In addition, I have attended 110 meetings, details of which are at **Appendix 5**. The purpose of these meetings was to gather information and enable discussion of topics more suited to a 'round table' setting, for example:
- (a) briefings from NSW Health and other government departments on their roles;
 - (b) discussions with professional bodies including the Australasian College of Emergency Medicine, the NSW Nurses Association and the Society of Hospital Pharmacists of Australia about their concerns;
 - (c) meetings with patients or their families, including the Anderson family;
 - (d) meetings with stakeholder groups; and
 - (e) meetings with independent health policy and research institutes such as the Sax Institute.

Expert panels

- 1.44 The terms of reference enabled me to seek advice of eminent persons, either from other states and territories of Australia, or from overseas.
- 1.45 On 15 and 16 September 2008, I convened a 2 day expert panel with a broad range of experts to discuss the issues considered in my report. A list of those experts appears at **Appendix 6**.
- 1.46 Further, on 29 September 2008, I convened a one day expert panel with experts in the field of child and adolescent health to discuss the issues considered in my report in respect of babies, children and young people. A list of those experts also appears in **Appendix 6**.

Special Investigations

- 1.47 In addition to general hearings, I conducted a series of hearings to investigate the following specific matters:
- (a) the conduct of Graeme Reeves, in respect of which I delivered a First Report on 31 July 2008; and
 - (b) the creation of a virtual ward in the Emergency Department at Shellharbour Hospital, and the treatment of the doctor who exposed this practice, in respect of which I held 4 days of hearing (**Appendix 8**).

Summons

- 1.48 To collate the vast amount of information needed to address the terms of reference, I, at the request of my staff issued 49 summonses to various organisations to produce specified documents and classes of documents. As well, the Inquiry made numerous requests to NSW Health and other organisations for information.
- 1.49 All documents produced to the Inquiry were analysed by my staff. The Inquiry generated a database containing over 30,000 documents, comprising 221,430 pages.

Feedback forums

- 1.50 Finally, in the course of finalising the recommendations set out in my report, I held 2 feedback forums.
- 1.51 On 16 October 2008, I held a feedback forum with the chief executives of the area health services and senior NSW Health representatives listed in **Appendix 7**.
- 1.52 On 17 October 2008, I held a feedback forum with a variety of frontline staff from each area health service, the NSW Ambulance Service and Justice Health. In attendance were doctors, nurses and allied health practitioners, paramedics, administrators, clerical staff and community representatives. I list those who attended in **Appendix 7**.
- 1.53 I found the comments of the attendees frank, perceptive and extremely useful in refining my thinking. I am most grateful to all of them for attending and contributing to the development of this report.

Scope of this Inquiry

- 1.54 There are 251 public hospitals in NSW,³⁹ ranging in size from major metropolitan hospitals such as Royal Prince Alfred Hospital to remote Multi-Purpose Services in Bourke. These hospitals serve diverse communities from inner city to indigenous to non-English speaking populations.
- 1.55 The terms of reference encompass all such hospitals and I have endeavoured to visit as many as possible.
- 1.56 An understanding of two key terms, "acute care services" and "models of care" is important in understanding the scope of this Inquiry.

Acute care services

- 1.57 In everyday language, "acute care" refers to medical services such as surgery, intensive care, medical and nursing care, which are provided for the immediate assessment and treatment of patients.⁴⁰
- 1.58 The term "acute care" is used in a broader and more technical sense by NSW Health as follows:⁴¹

"Acute care is where the principal clinical intent is to do one or more of the following:

manage labour (obstetrics);

cure illness or provide definitive treatment of injury;

perform surgery;

relieve symptoms of illness or injury (excluding palliative care);

reduce severity of an illness or injury;

protect against exacerbation and / or complications of an illness and / or injury which could threaten life or normal function; and

perform diagnostic or therapeutic procedures."

- 1.59 According to NSW Health, “acute care” does not include “sub acute” or “non acute” care such as:⁴²
- (a) rehabilitation;
 - (b) palliative care;
 - (c) psychogeriatric care;
 - (d) geriatric evaluation and management; or
 - (e) maintenance care (including respite care, some nursing home care, or the provision of care in a psychiatric unit over an indefinite care period).
- 1.60 The term “acute care” is used somewhat differently in the federal arena depending upon the context in which the term is being used.⁴³
- 1.61 For the purposes of this Inquiry, I have adopted the meaning of the term used by NSW Health, which essentially covers most treatment provided in NSW public hospitals.
- 1.62 As a practical matter, there are also a number of matters which are not “acute care services” but nonetheless impact on the delivery of acute care services in NSW public hospitals. These are:
- (a) transport systems, which bring patients to hospitals and return them to their homes, and which I have discussed in Chapter 27; and
 - (b) the treatment of patients in the community, to take the pressure off NSW public hospitals, which I have discussed in Chapter 21.

Models of care

- 1.63 During my inquiry, the term “models of care” has been used to refer to various concepts. I have explored these in more detail in Chapter 16.
- 1.64 It is sufficient for present purposes to refer to the definition provided to me by the Greater Metropolitan Clinical Taskforce, according to which a model of care is a consensus developed by a group of informed clinicians about how medical care should be provided in their particular domain of activity. According to the Greater Metropolitan Clinical Taskforce, a model of care:
- (a) has to be consensual;
 - (b) has to be based on evidence;
 - (c) has to have a plan attached to it; and
 - (d) has to have an outcome capable of being assessed.⁴⁴
- 1.65 Having a clearly defined and articulated model of care helps ensure that clinicians are:
- “‘viewing the same picture’, working towards a common set of goals and, more importantly, are able to evaluate performance on an agreed basis.”⁴⁵
- 1.66 Elsewhere in my report, I have discussed specific models of care as follows:
- (a) models of care in relation to the treatment of chronic, complex and elderly patients in Chapter 3;
 - (b) models of care in relation to maternity in Chapter 4;
 - (c) models of care in relation to the treatment of babies, children and young people in speciality facilities in Chapter 5;

- (d) models of care in relation to nursing in Chapter 8;
- (e) models of care in respect of communication between health professionals in Chapter 15;
- (f) models of care in respect of hospital acquired infection in Chapter 18;
- (g) models of care in respect of deteriorating patients in Chapter 19;
- (h) models of care in relation to treatment of patients in Emergency Departments to deal with overcrowding, in Chapter 20;
- (i) models of care in relation to treatment of patients in the community, in Chapter 21;
- (j) models of care in relation to mental health, in Chapter 22;
- (k) models of care in relation to surgery, in Chapter 23;
- (l) models of care in relation to avoidable transportation of patients by ambulance, in Chapter 27; and
- (m) models of care in relation to discharge of patients in Chapters 20 and 28.

Structure of my report

- 1.67 As can be seen from the table of contents, my report traverses a large array of topics, which are arranged as follows.

Patients

- 1.68 No analysis of the NSW public hospital system can begin without an appreciation of the patients whom it serves. Accordingly, **Part A** of my report concerns patients. Chapter 2 provides a general discussion of NSW patients, including the challenges presented by increasing demand.
- 1.69 Particular groups of patients who warrant special mention due to difficulties these groups of patients are presently experiencing in NSW public hospitals are then examined as follows:

Chapter 3 Chronic, complex and elderly patients

Chapter 4 Mothers

Chapter 5 Babies, children and young people

Chapter 6 Rural patients

Workforce

- 1.70 **Part B** of my report deals with the problems faced by the workforce in NSW public hospitals, without which the system would simply cease to function.
- 1.71 There are about 91,000 full time equivalent⁴⁶ staff employed by NSW Health, the NSW Ambulance Service and area health services as at June 2007.⁴⁷ Of these:
- 7,318 are medical staff;
 - 38,101 are nursing staff;
 - 7,387 are allied health & pharmacy; and

- 3,307 are ambulance officers⁴⁸.

About 65.5% of staff are clinically involved in the care of patients⁴⁹ as opposed to support services such as catering, cleaning, maintenance and administration.

- 1.72 I was truly impressed by the dedication of this workforce, working as it does in quite difficult circumstances. It is, however, a workforce under a great deal of strain, and in **Part B** I have sought to address the problems which this workforce is facing. If these problems are not fixed in the near future, then I am concerned that the dedication and endurance of the workforce will not be sustainable and the delivery of health care in our hospitals will suffer. Part B contains the following chapters concerning workforce:

- Chapter 7 Doctors
- Chapter 8 Nurses
- Chapter 9 Allied health & pharmacy
- Chapter 10 Education & training
- Chapter 11 Workforce reforms
- Chapter 12 Bullying & workplace culture

Volunteers

- 1.73 Although not specifically discussed in Workforce, may I here acknowledge the immense contribution made by volunteers to the operation of NSW public hospitals. Volunteers have a variety of roles including catering, gardening, running hospital shops, serving meals to patients, flower arranging, counselling and fund raising.
- 1.74 There are more than 6,300 volunteers providing 1.24 million unpaid hours across NSW.⁵⁰ In 2006, volunteers raised more than \$7.3 million for equipment and other patient comforts.
- 1.75 In many hospitals I visited, I saw volunteers guiding patients and their families around large hospital facilities, pushing wheelchairs and providing social interaction. Hospital staff, particularly managers, frequently made a point of telling me of the vital contribution of these many people.

Communication

- 1.76 In **Part C** of my report, I have addressed the main issues raised by paragraph 2 of the terms of reference, being:
- Chapter 13 Supervision of junior clinical staff
 - Chapter 14 Clinical records & Information Technology
 - Chapter 15 Communication
- 1.77 In respect of communication, I have not restricted my remarks to communication between health professionals involved in the care of a patient, but have also examined communication with a patient and their family or carer, as this needs some improvement.

Patient safety

1.78 In **Part D** of my report, I have looked at how patient safety needs to be improved, and can be improved in NSW public hospitals, in the following chapters:

Chapter 16 Safety & quality

Chapter 17 Key performance indicators

Chapter 18 Hospital acquired infection

Chapter 19 Deteriorating patients

Areas of medical treatment

1.79 In **Part E** of my report, I have focused on particular areas of medical practice in respect of which institutional and systemic problems arose in a significant number of the submissions and also in the evidence which I received, being:

Chapter 20 Emergency Department

Chapter 21 Community health

Chapter 22 Mental health

Chapter 23 Surgery

Chapter 24 Pathology & medical imaging

Practical components

1.80 In **Part F** of my report, I have examined institutional and systemic issues in relation to the basic elements required to run a hospital: money, the collection of services in a hospital, transport of patients to and from the hospital, beds, food, equipment and the like.

Chapter 25 Funding

Chapter 26 Hospitals

Chapter 27 Transport

Chapter 28 Beds

Chapter 29 Food

Chapter 30 Equipment

Chapter 31 Administration & management

Ensuring change

1.81 Finally, in **Part G** of my report, I deal with the challenge at a government and a departmental level to successfully implement and enable change across a large, complex organisation which must still deliver safe, good quality treatment to patients whilst at the same time implementing extensive changes in the way things are done.

- 1.82 The NSW health system is complex. It serves a large geographic area. It has been the subject of many Inquiries by a variety of organisations and people, often into a single issue or a single facility or service. My Inquiry has been the most comprehensive of any to date, but, yet, in the time available can only deal with some of the issues raised. I have tried to identify those which are the most significant. However, my Inquiry will only have a lasting effect if there is a broad acceptance of the findings and a determination on the part of all people involved with NSW Health to adapt to the changes recommended with goodwill and an open mind to the benefits which change will bring.
- 1.83 In examining some of the obstacles to health care reform Ms Anne-Marie Feyer made the point during her presentation to the Inquiry that:
- "The overwhelming need to win hearts and minds is critical but often ignored. I don't think you can assume motivation..."⁵¹
- 1.84 NSW Health will not be able to move forward to embrace system wide reforms without the support of the community. This necessitates leadership from all involved in the political process to accept that the good of all citizens in NSW, and the provision of health care in an orderly and systematic way, must prevail over individual, sectional or geographical interests whose motivation is largely, if not entirely, self interest. It necessitates strong leadership from all the clinicians and managers who work within, or as a part of, NSW Health.
- 1.85 Change requires time, patience and determination. It can only succeed if the central purpose is kept constantly in mind, namely that every person who comes to be cared for in a public hospital in NSW should be treated with respect by an appropriately skilled clinician in a safe and cost effective way to achieve the best health outcome possible for the patient.

¹ Prof Hughes, C. and Prof Walters, W., *Report of Inquiry into the Care of a Patient with Threatened Miscarriage at Royal North Shore Hospital on 25 September 2007*, 2007, NSW Health, North Sydney, pp. 6-7.

² Prof Hughes, C. and Prof Walters, W., *Report of Inquiry into the Care of a Patient with Threatened Miscarriage at Royal North Shore Hospital on 25 September 2007*, 2007, NSW Health, North Sydney, p. 8.

³ Natasha Wallace, "Revealed: horror at a packed hospital" *The Sydney Morning Herald*, 16 October 2007.

⁴ Prof Hughes, C. and Prof Walters, W., *Report of Inquiry into the Care of a Patient with Threatened Miscarriage at Royal North Shore Hospital on 25 September 2007*, 2007, NSW Health, North Sydney, p. 9.

⁵ Letter from NSW Health to Special Commission of Inquiry, 21 October 2008, pp. 10-11.

⁶ Letter from NSW Health to Special Commission of Inquiry, 21 October 2008, p. 11.

⁷ Letter from NSW Health to Special Commission of Inquiry, 21 October 2008, p. 10.

⁸ Letter from NSW Health to Special Commission of Inquiry, 21 October 2008, p. 10.

⁹ Letter from NSW Health to Special Commission of Inquiry, 21 October 2008, p. 10.

¹⁰ Ms Cass's experiences were recounted in "Birth in toilet in hospital without care", *The Sydney Morning Herald*, 27 September 2007; Jenny Langmaid's experience was recorded by Kate Benson and Alexandra Smith, "It's Third World Care", *The Sydney Morning Herald*, 27 September 2007; Cecille Heath by Kate Benson, "Doctors looked for foetus in bin", *The Sydney Morning Herald*, 28 September 2007; Cathy Wastell by Robinson, "Shocked mums relive miscarriage ordeals", *Manly Daily*, 28 September 2007. Leng Lui to Kate Sikora, "Patients expose the hospital of horrors", *The Daily Telegraph*, 28 September 2007; Jodie

Patterson in Kate Benson and Brian Robbins, "Flood of callers tell of hurt left by miscarriage apathy" *The Sydney Morning Herald*, 2 October 2007 ; Rosemarie Milsom, "Painful memories of losing a small, perfectly formed son," *The Sydney Morning Herald*, 2 October 2007.

- 11 Joe Hildebrand, "Hospital symptom of a sick system", *The Daily Telegraph*, 27 September 2007; Benson, Smith & Wallace, "A bit rich: lemma's class wards", *The Sydney Morning Herald*, 28 September 2007; "Call for hospital inquiry" *The Sydney Morning Herald*, 28 September 2007; Cresswell and Wilson, "Baby loss case not a one-off: doctors", *The Australian*, 28 September 2007; Gabriel Wingate-Pearse, "Doctors wary of Inquiry", *Newcastle Herald*, 26 January 2008.
- 12 "Nurses juggle lives on a 17-hour shift", *The Daily Telegraph* 4 October 2007.
- 13 Kate Sikora, "Staff morale at an all-time low: senior nurse", *The Daily Telegraph*, 28 September 2007; Pressure on nursing staff was said by some patients and their families to lead to appalling attitudes: "Nurses juggle lives on a 17-hour shift", *The Daily Telegraph* 4 October 2007.
- 14 Alexandra Smith, "State of Emergency Grips Cash-Starved Hospitals", *The Sydney Morning Herald*, 1 October 2007
- 15 "Leading doctor slams system", *The Daily Telegraph*, 28 September 2007; Alexandra Smith, "We're at breaking point, hospitals tell minister", *The Sydney Morning Herald*, 3 October 2007; Kate Benson, "Patients left to slash themselves", *The Sydney Morning Herald*, 9 October 2007; Janne Seletto, "Crisis in locum doctors", *The North Shore Times*, 19 September 2007.
- 16 "Staffing emergency", *The Daily Telegraph*, 9 October 2007; citing Australian Salaried Medical Officers Association survey.
- 17 "Band-aid fix won't cure ill health care", *The Daily Telegraph*, 2 October 2007;; "Sick health system," *The Daily Telegraph* 3 October 2007; Joe Hildebrand, "Hospital symptom of a sick system", *The Daily Telegraph*, 27 September 2007; Katrina Adamski, "Nurses fed up with conditions", *The North Shore Times*, 28 September 2007; *The Sunday Telegraph*, 14 October 2007; "Labor's big bed strip", *The Daily Telegraph*, 10 October 2007; "Stretchers become beds", *The Daily Telegraph*, 10 October 2007; Kate Sikora, "Hospital Death Queues", *The Daily Telegraph*, 2 November 2007.
- 18 A baby boy having to wait 5 hours to get a serious head cut attended to: "Dad's hospital 'war zone' fury" *The Daily Telegraph*, 17 October 2007; A girl having to wait for 24 hours for an operation on a broken arm: "Another horror at hospital", *The Central Coast Extra*, 26 October 2007.
- 19 Tim Blair, "Meagher attacks! Mega moth stalks sicko city", *The Daily Telegraph*, 19 October 2007; "Reba revolt", *The Daily Telegraph*, 11 October 2007; "So is trauma boss wrong too Reba," *The Daily Telegraph* 11 October 2007.
- 20 Family of a dying man, Phil Lindsay, paid for a private nurse to care for him in a public ward at Royal North Shore Hospital as there were not enough staff to look after him: Kate Benson, "It's BYO nurse at hospital in crisis" *The Sydney Morning Herald*, 2 October 2007. Elizabeth Tague, aged 85, had her son stay with her around the clock due to family concerns about the lack of nursing care. Mrs Tague was kept in a storeroom overnight as her hallucinations disturbed other patients: "Nurses juggle lives on a 17-hour shift", *The Daily Telegraph*, 4 October 2007 ; "Hospital a perilous journey", *The Daily Telegraph*, 4 October 2007.
- 21 Natasha Wallace, "More beds, more staff the key, doctors say", *The Sydney Morning Herald*, 4 October 2007
- 22 Natasha Wallace, "Sorry, this hospital's not working", *The Sydney Morning Herald*, 18 October 2007.
- 23 Natasha Wallace, "Crowded hospitals in danger zone", *The Sydney Morning Herald*, 26 October 2007;; "NSW has nation's worst hospitals", *The Daily Telegraph*, 26 October 2007.
- 24 Natasha Wallace, "Crowding linked to deaths in hospitals", *The Sydney Morning Herald*, 24 November 2007 citing Associate Professor Drew Richardson, ANU.
- 25 Letter from NSW Health to Special Commission of Inquiry, 21 October 2008.
- 26 Letter from NSW Health to Special Commission of Inquiry, 21 October 2008, p 2.

-
- 27 Letter from NSW Health to Special Commission of Inquiry, 21 October 2008, p 2.
- 28 Letter from NSW Health to Special Commission of Inquiry, 21 October 2008, p 3.
- 29 Letter from NSW Health to Special Commission of Inquiry, 21 October 2008, p 4.
- 30 Natasha Wallace, "Emergency team rejects report on miscarriage", *The Sydney Morning Herald*, 1 November 2007.
- 31 New South Wales Parliament, *Report on Inquiry into the Royal North Shore Hospital*, Joint Select Committee on the Royal North Shore Hospital, December 2007, New South Wales Parliament Legislative Council, Sydney, p 24.
- 32 New South Wales Parliament, *Report on Inquiry into the Royal North Shore Hospital*, Joint Select Committee on the Royal North Shore Hospital, December 2007, New South Wales Parliament Legislative Council, Sydney, xiii-xvii.
- 33 Parliament of NSW, *NSW Government Response to the Report of the Inquiry of the Joint Select Committee on Royal North Shore Hospital*, 2008, Parliament of NSW, Sydney, p.3.
- 34 NSW Health, Northern Sydney Central Coast Area Health Service, *Agenda Item 9.1 Second Progress Report on Recommendations Arising from the Joint Select Committee on Royal North Shore Hospital*. June 2008, NSW Health, p i. (MEET.007.0445)
- 35 Inquest into the death of Vanessa Ann Anderson, (Unreported, Westmead Coroners Court, Westmead File 161/2007, Magistrate Milovanovich, 24 January 2008).
- 36 Inquest into the death of Vanessa Ann Anderson, (Unreported, Westmead Coroners Court, Westmead File 161/2007, Magistrate Milovanovich, 24 January 2008) p15.
- 37 Arlington, "Hospital Hell", *The Daily Telegraph*, 25 January 2008.
- 38 Terms of reference; sections 22, 23 and 24, *Special Commissions of Inquiry Act 1983(NSW)*: I was authorized to issue warrants for the apprehension of witnesses, compel the answering of questions and production of documents notwithstanding that it may incriminate the witness, and to punish persons for contempt.
- 39 I note that the total number of hospitals reported may differ according to administrative and/or reporting arrangements. The total may not reflect the number of physical hospital buildings in the state. Australian Institute of Health and Welfare, *Australian Hospital Statistics 2006/2007*, Australian Institute of Health and Welfare, Canberra, p 18 <http://www.aihw.gov.au/publications/hse/ahs06-07/ahs06-07-c02.pdf> (16 October 2008).
- 40 *Macquarie Dictionary*, revised 3rd edition, 2001. Similarly, in the United States, "acute care" means short-term medical treatment, usually in a hospital, for patients having an acute illness or injury or recovering from surgery: *American Heritage Medical Dictionary*, 2004. See also Merriam-Webster Dictionary: providing or concerned with short-term medical care especially for serious acute disease or trauma. However, as the Organisation for Economic Co-operation and Development (OECD) has observed, the functions of care included or excluded in "acute care" vary across countries and time (the OECD considers that acute care refers to "curative care"): OECD, *Health at a Glance*, 2007, OECD Paris, p. 62.
- 41 Report of the NSW Health Council, *A Better Health System for NSW*, NSW Government, Better Health Centre Publications Warehouse, Gladesville, p. 98; letter from NSW Health to Special Commission of Inquiry, February 2008, p. 1, citing *NSW Health Services Comparison Data 1998/99, 2000*, p. 171.
- 42 Letter from NSW Health to Special Commission of Inquiry, February 2008, p. 1, citing Eager K. et al, *The Australian National Sub-Acute and Non-Acute Patient Classification: Report of the National Sub-Acute and Non-Acute Casemix Classification Study*, 1997, Centre for Health Service Development, University of Wollongong; *NSW Health Services Comparison Data 1998/99, 2000*, p. 190.
- 43 This definition is not consistently used in the Commonwealth Government arena (Steering Committee for the Review of Government Services Provision, *Report on Government Services 2008* Volume 2 p 10.3. cf Commonwealth Department of Health and Ageing, Healthcare Services and Financing Branch, *The State of our Public Hospitals*, Report, June 2007, p 28.) where a distinction is sometimes drawn between "acute medical care", "acute medical procedures", "surgery", "maternity services" and "non acute care". "**Acute medical care**", which includes patients admitted to hospital with a severe condition, such as a heart attack, which does not require immediate surgery. This accounts for about 65% of public hospital admissions across Australia. "**Acute medical procedures**", which are usually

undertaken with specialised equipment, usually do not require a general anaesthetic, and often require the patient to be in hospital for less than a day. These procedures account for about 6% of admissions to public hospitals across Australia. **"Surgery"**, **"Maternity services"** and **"Non acute care"** are separately considered.

- ⁴⁴ Professor Peter Castaldi, meeting with Greater Metropolitan Clinical Taskforce, 7 March 2008, transcript 44.46-45.4
- ⁴⁵ Davidson, P. M., Halcomb, E. J., Hickman, L., Phillips, J., & Graham, (2006) *Beyond the rhetoric: What do we mean by a model of care?*, 23(3) Australian Journal of Advanced Nursing, p. 49.
- ⁴⁶ Full time equivalent or FTE staffing numbers are calculated based on Area Health Services payroll costing data : South Eastern Sydney Illawarra Area Health Service, *South Eastern Sydney Illawarra Area Health Service Summary by Skill and FTE as at November 2007*, NSW Health, North Sydney, p1. (SESI.001.0067)
- ⁴⁷ NSW Health, *Annual Report 2006/07*, 2007, NSW Health, North Sydney Appendix 4, p 232.
- ⁴⁸ NSW Health, *Annual Report 2006/07*, 2007, NSW Health, North Sydney Appendix 4, p 232.
- ⁴⁹ Includes staff engaged in face to face care, not including ward clerks, wardsmen and surgical dressers: NSW Health, *Annual Report 2006/07*, 2007, NSW Health, North Sydney Appendix 4, p 232.
- ⁵⁰ Volunteers provide a vital contribution in many hospitals; NSW Health, 'Volunteers Praised for Vital Work in Public Health' (Media Release, 16 February 2007)
- ⁵¹ Anne Marie Feyer, Change Implementation and Management: Some Observations from the NSW Clinical Services Program, Experts Conference, 15 September 2008, transcript 105.31-3.



Special Commission of Inquiry

Acute Care Services in NSW Public Hospitals

Part A

Patients

2 Patients

General characteristics of NSW patients	20
Uneven geographic distribution	20
An ageing population	21
Types of treatments received	23
Satisfaction with the treatment received	25
Complaints	25
Increasing demand	26
Conclusion	27
A serious discussion	27
End of life decisions	29
Appreciating the actual cost of services	30
Conclusion	30
Particular groups of patients	30
Indigenous patients	31
Issues pertinent to indigenous patients	33
Indigenous infant and maternal health	33
Non-English speaking patients	34

General characteristics of NSW patients

- 2.1 No review of the adequacy of medical treatment provided by NSW's public hospitals can begin without an appreciation of the patients who are served by these hospitals.

Uneven geographic distribution

- 2.2 Living in NSW, it is easy to forget the significant challenges posed by the sheer size of the state and the distribution of its population.
- 2.3 The geographic area of NSW is 800,642 square kilometres.¹ This is roughly 3 times the total area of the UK, twice the size of Japan or twice the area of Germany.²
- 2.4 One in 3 Australians live here. As at 30 March 2008, the population of NSW was 6,947,000³ and growing at a rate of 1.1% per year.⁴ This equates to an annual population increase of 72,400 people.⁵
- 2.5 The NSW population is not distributed evenly over the state, but concentrated in the Sydney region and surrounding coastal areas as shown in the map below.⁶

Estimated residential population distribution—June 2006



- 2.6 Everyone who lives in NSW is entitled to expect that, if they need medical treatment in a hospital, they can access it. This means that the public hospital must be reasonably close to where they live or, if not, there must be a retrieval system available to get them to one quickly.
- 2.7 It is obviously not enough to have a hospital building alone close by. The hospital must be staffed by capable and appropriately trained doctors and nurses who can treat the patient competently. Those staff need to have all of the necessary equipment, medication and technology at their disposal to deliver medical care to a standard we expect in Australia.
- 2.8 Satisfying these fundamental expectations of patients presents a considerable challenge in a state of the land area of NSW, where the population is scattered throughout rural and remote areas in not insignificant numbers. Whilst the same challenges face other types of government services, such as education, the same life and death consequences are not likely if the provision of service fails. Chapter 6 of my

report focuses particularly on dealing with the problems of providing hospital care in rural NSW.

An ageing population

- 2.9 An important feature of our population, from the point of view of the NSW public hospital system, is that it is ageing. There are 2 main factors contributing to this.

Living longer

- 2.10 First, we are simply living longer than we used to. The life expectancy of NSW men⁷ is 79.2 years. The life expectancy of NSW women is 84.2 years⁸. In both cases, NSW life expectancies exceed average life expectancy in most OECD countries.⁹ The chart below shows life expectancy in the top 20 OECD countries.

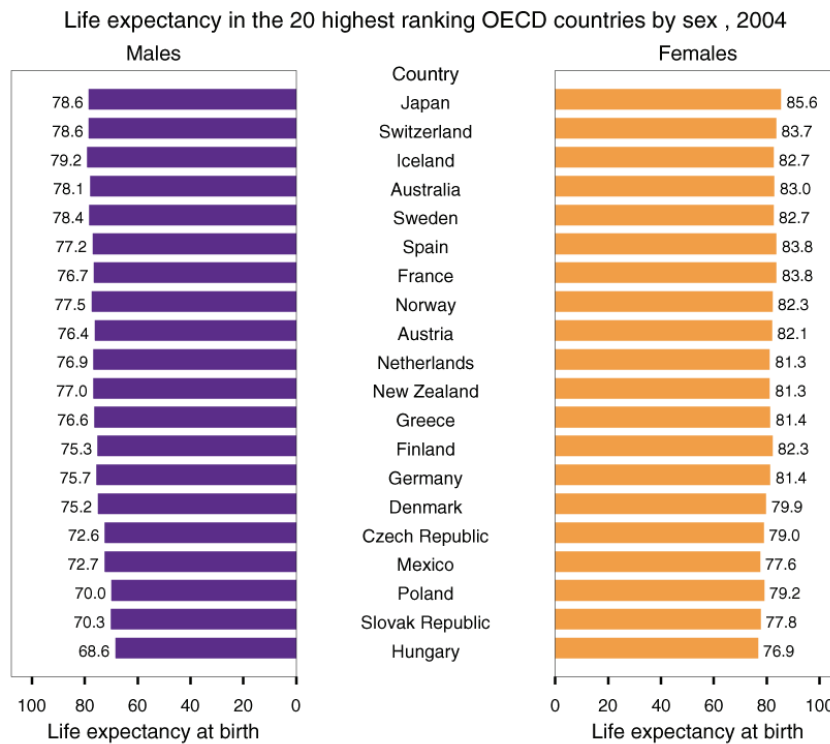

Note: Includes OECD countries where data was available for 2004. Ranking is by both sexes combined.

Source: The OECD Health Data 2006. OECD, Paris 2006.

- 2.11 Life expectancy for Australian males ranks 5th among the 20 highest ranking OECD countries while life expectancy for Australian females ranks 4th among the same countries.
- 2.12 Our life expectancy is also increasing every year. From 2001 to 2005, female life expectancy increased by 0.8 years and male life expectancy by 1.2 years.¹⁰ Longer life expectancy mainly results from reduced deaths from all causes, better treatment for common diseases and a healthier older population. The chart below illustrates how the death rate per 100,000 of population has decreased from 1972 to 2004 in NSW. The death rate is decreasing because we have been effective in reducing some of the major causes of death such as smoking and injury (including road deaths).¹¹

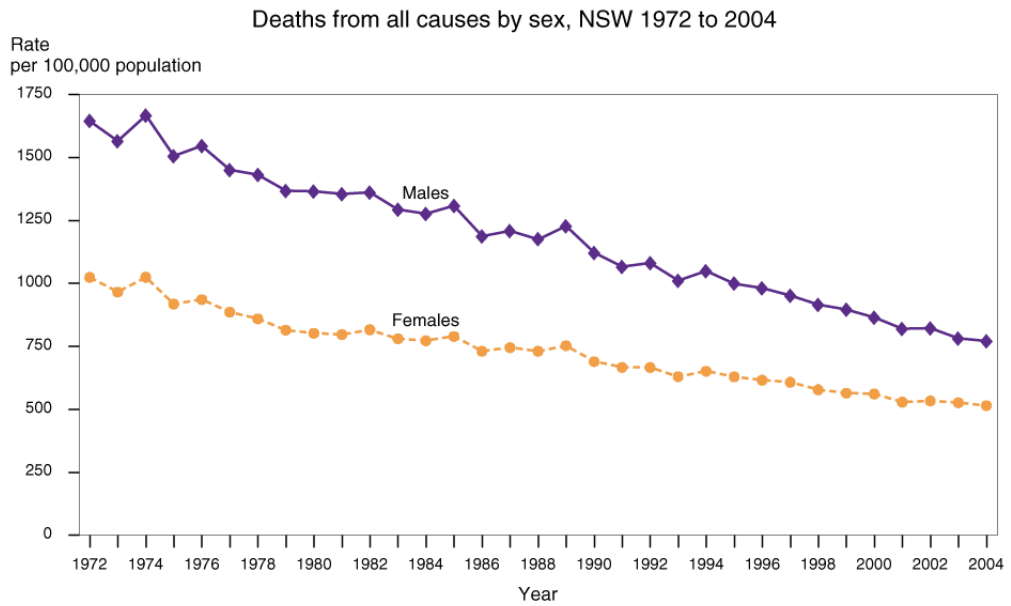

'Baby boomers'

- 2.13 Second, the proportion of older people is increasing as 'baby boomers' are beginning to retire and grow old. Baby boomers are those Australians who were born between 1946 and 1965 in the baby boom after the end of World War II in 1945, including those who migrated to Australia from other countries during this period.¹²
- 2.14 The age profile of NSW can be seen in the graph below, which shows population projections by age group for NSW from 1998 to 2016.

Proportion by age group 1998 - 2016

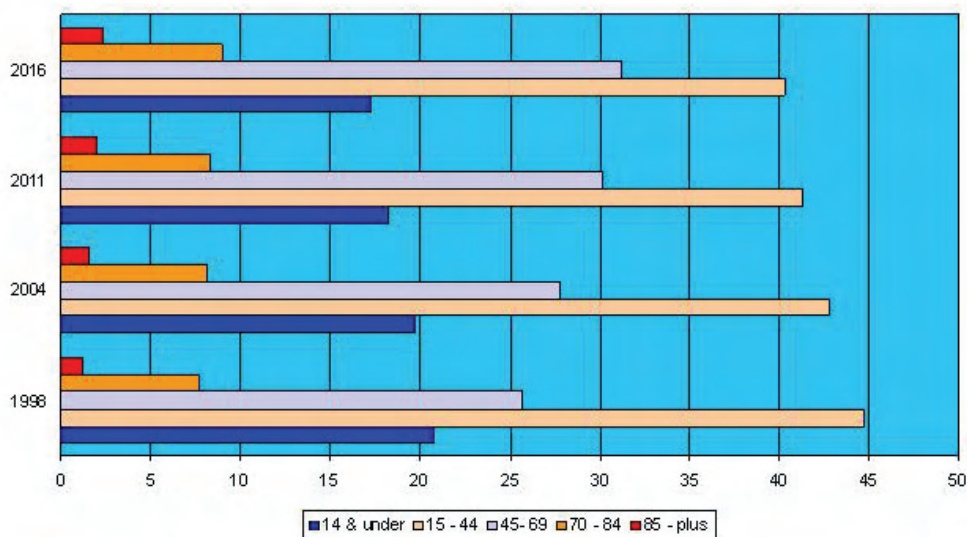

- 2.15 The graph shows that over time the older age groups are expected to increase as a proportion of the whole of the population.
- 2.16 The demographic changes brought about by the ageing of the baby boomers will create an increase in demand for health services and has been described as one of the major drivers of increased health care expenditure.¹³ As Professor Picone, Director General of NSW Health told me:

There is no precedent in history for what is about to happen.¹⁴

- 2.17 Apart from common childhood ailments, most people get through life without the need for hospital medical treatment, until their later years. It is then that problems such as heart disease, dementia, Alzheimer's disease, arthritis and Parkinson's disease begin to emerge, often in combination.
- 2.18 Although only 13.5% of the population of NSW is over 65 years of age,¹⁵ as can be seen from the graph below, 33% of hospital admissions in NSW public hospitals in 2006-07 were from this age group.

**Admitted Patient Episodes in NSW Public Hospitals
by Age Group (July 2006 to June 2007)**

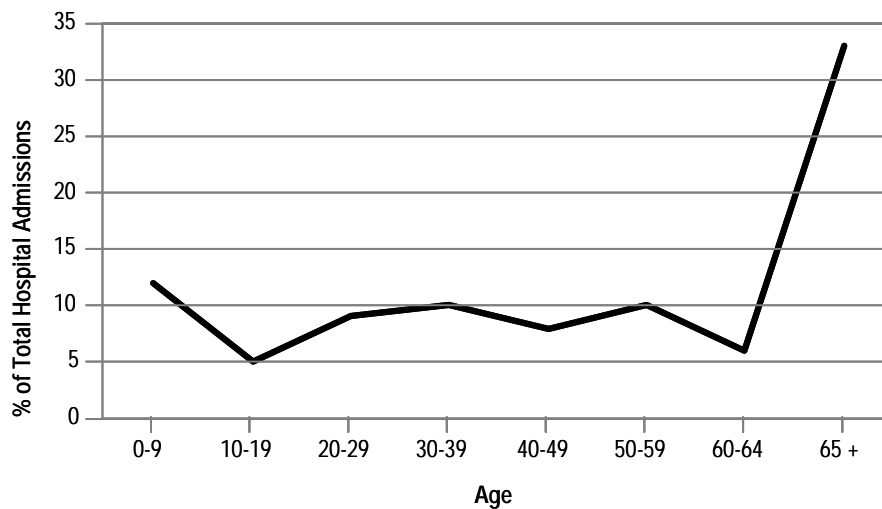

- 2.19 In terms of acute care, looking after people aged 65 and over accounts for almost half of all bed days in NSW public hospitals.¹⁶ In 2005-06, they also represented approximately 303,725 or 19.5% of the total 1,560,364 Emergency Department attendances at hospitals in NSW.¹⁷ Whilst the average length of stay of all NSW public hospital patients is 3.6 days,¹⁸ for patients aged over 65 years, the average length of stay was approximately 5 days.¹⁹
- 2.20 Clearly, these figures represent the tip of a very big iceberg that is bearing down on NSW public hospitals, and I have spent some time focusing on how we can better deal with aged care in the hospital system in Chapter 3. If we could solve this problem alone, then on one view, many of the problems in NSW public hospitals would also be solved.

Types of treatments received

- 2.21 The type of specialty services delivered to patients in NSW public hospitals is illustrated in the chart below. It provides an indication of the broad range of conditions for which patients received treatment in NSW hospitals during 2004-05. This pattern continues today.

Hospital separations by category of cause and sex, NSW 2004-05

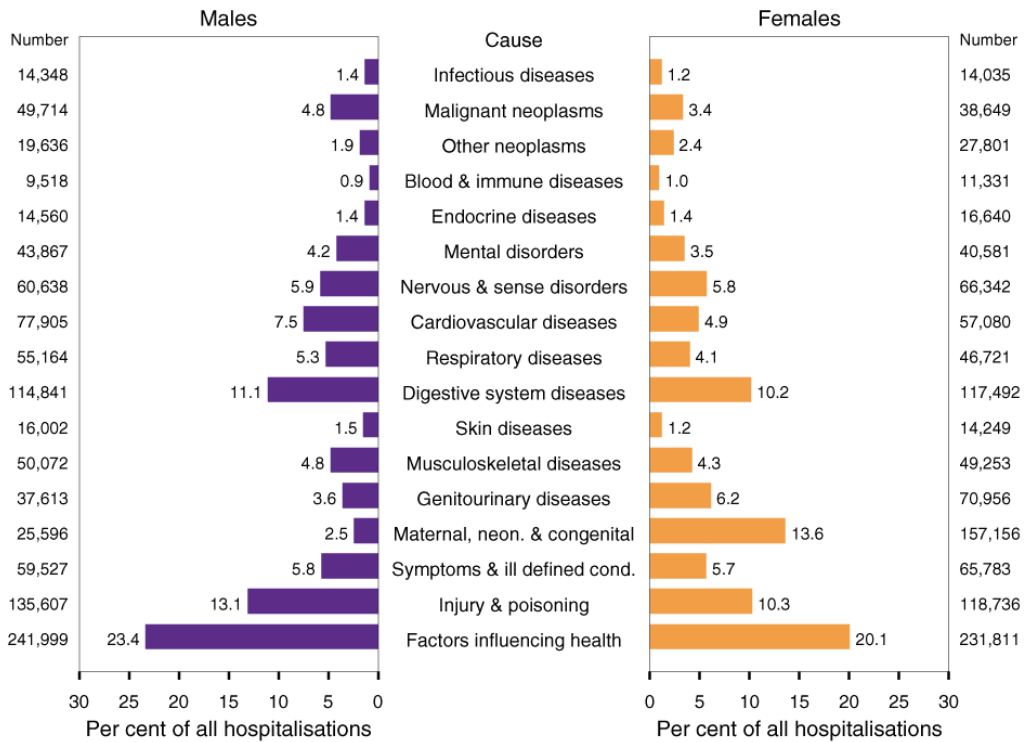

Note: Hospital separations were classified using ICD-10-AM. Grouping follows ICD-10 categories, so numbers for some categories may differ from results in other chapters. See ICD Codes for diseases and procedures for details. Numbers for 2004–05 include an estimate of the small number of interstate hospitalisations, data for which were unavailable at the time of production.

Source: NSW Inpatient Statistics Collection and ABS population estimates (HOIST). Centre for Epidemiology and Research, NSW Department of Health.

- 2.22 Cancer, cardiovascular disease and mental illness are the 3 primary causes of illness in Australia.²⁰ In addition, diabetes has also been increasing from 5% of total prevalent disability in 1993 to 6% in 2003.²¹ This figure is expected to increase by a further 50% by 2023 if the growing incidence of obesity continues.²²
- 2.23 The number of medical procedures available today has increased exponentially over the last 2 decades. The 2005 Productivity Commission Report, *Impact of Advances in Medical Technology in Australia*, points to a number of recent advances as contributing to this increase including MRI and CT scanning, angioplasty to unblock arteries and laparoscopic surgery.²³
- 2.24 Medical technology is recognised as one of the primary drivers of increased health care expenditure.

In 1995 the US National Institute of Neurological Disorders and Stroke (NINDS) reported a clinical trial in the New England Journal of Medicine which caused a paradigm shift in the treatment of acute stroke.²⁴ This study supported the use of a new medication that can break apart (or thrombolysed) the clots that cause acute stroke. While studies using similar agents to thrombolysed strokes have been cited as far back as 1958 the benefits they reported were either minor or associated with a greater degree of risk in some patients.²⁵ The NINDS trial found that the new drug could be used safely in stroke patients with a benefit at 90 days.²⁶ As a result the clinical treatment of stroke patients was altered entirely, with the new drug being routinely administered to stroke patients upon the early onset of stroke.²⁷

- 2.25 Advances in medical technology in fields such as cancer treatment, organ transplants, 'spare parts' and the long term support of disabled people have led to our hospitals starting to fill up.²⁸ Hospital admissions are on an upward spiral. Some have said, that without an intervention akin to the medical breakthrough which occurred with the development of penicillin or the introduction of public immunisation programmes, this trend will not be reversed.²⁹
- 2.26 In addition to these drivers of increasing demand, there is also a greater public expectation of the quality and standard of care provided by our public hospitals.³⁰ The availability of information through the media including the internet encourages this trend, which is not matched by an increasing public perception of the budgetary environment in which our public health system operates.

Satisfaction with the treatment received

- 2.27 The *NSW Health Patient Survey* conducted by NSW Health in 2008 found that, overall, 88% of adults gave a positive rating for the care they received when admitted to a NSW public hospital, slightly down on the 92% in the 2005 survey. (Mental health patients had the lowest satisfaction rate of 68% and community health patients had the highest rate at 96%.) When asked to rate their stay on a scale from 0 to 10, 40% of patients rated their stay as 9 or 10.
- 2.28 The 70,530 patients surveyed found NSW Health performed best in the following respects:
- respect for patient preferences;
 - access to care;
 - co-ordination of care; and
 - physical comfort

Patients also rated highly the courtesy of health professionals and how well doctors and nurses worked as a team.³¹

- 2.29 Of interest to me is that the following matters were of most concern to patients:
- (a) **Emotional factors:** feeling sympathy from nursing staff, being able to discuss their anxieties and fears with nursing staff, and being able to find someone easily with whom to talk about their concerns.
 - (b) **Communication factors:** receiving information from health professionals that they could understand, and being involved in decisions about their treatment. I have dealt with this further in Chapter 15.
 - (c) **Physical comfort factors:** whether their room was clean or noisy; whether the food was what they ordered, and whether it was the right temperature and tasty. I have dealt with this further in Chapter 29.
- 2.30 Indeed, patients seemed relatively uncritical of the medical treatment received, and appeared to assume that the medical care received was appropriate. This assumption is, generally speaking, well-founded.

Complaints

- 2.31 In 1993, the Health Care Complaints Commission was established to receive and assess complaints relating to health service providers, including public hospitals. In 2006-07, the Health Care Complaints Commission received 508 complaints in relation

to NSW public hospitals.³² Of these, the most common issue raised (70%) concerned the treatment received. Of these complaints:

- 51% concerned inadequate treatment,
- 38% concerned diagnosis, and
- 15% concerned medication.

The highest proportion of treatment issues were raised in complaints about Emergency Department.³³

2.32 The next most common issue raised was communication (13%), followed by access (9%).

2.33 In Chapter 15, I have examined the mechanisms by which patients, their families and hospital staff can complain about treatment received, or a particular doctor or nurse, and how those complaints are dealt with. In this regard, the experiences of Vanessa Anderson's family provides an important case study which is dealt with in Chapter 15.

Increasing demand

2.34 In 2006-07, there were 1.523 million admissions into NSW public hospitals, of which 449,000 came via the Emergency Department.³⁴ This represents an 8% increase on hospital admissions in the previous financial year.³⁵ In 2007-08 there were a total of 1,527,382 admissions to NSW public hospitals, of which 404,565 came via the Emergency Department.³⁶ This represents a 0.3% increase in hospital admissions over the previous financial year and a 2.9% increase in admissions via the Emergency Department.³⁷

2.35 A combination of the ageing population and advances in medical technology, each of which I have already discussed, has led to a growth of demand for hospital services in NSW in recent years exceeding the rate of population growth. Over the 4 year period between 2002-03 and 2006-07 there was:

- population growth of 3.08%;³⁸
- an 11.6% increase in hospital admissions and discharges (called separations);
- a 14.9% increase in Emergency Department attendances;³⁹
- a 5.5% increase in total bed days; and
- a 10.3% increase in non-admitted patient services.⁴⁰

2.36 This increasing demand is expected to accelerate. The chart below shows the projected increase in acute inpatient separations in NSW public hospitals from 2004 to 2022, compared with population growth over the same period.

NSW public hospitals - % growth from 2004

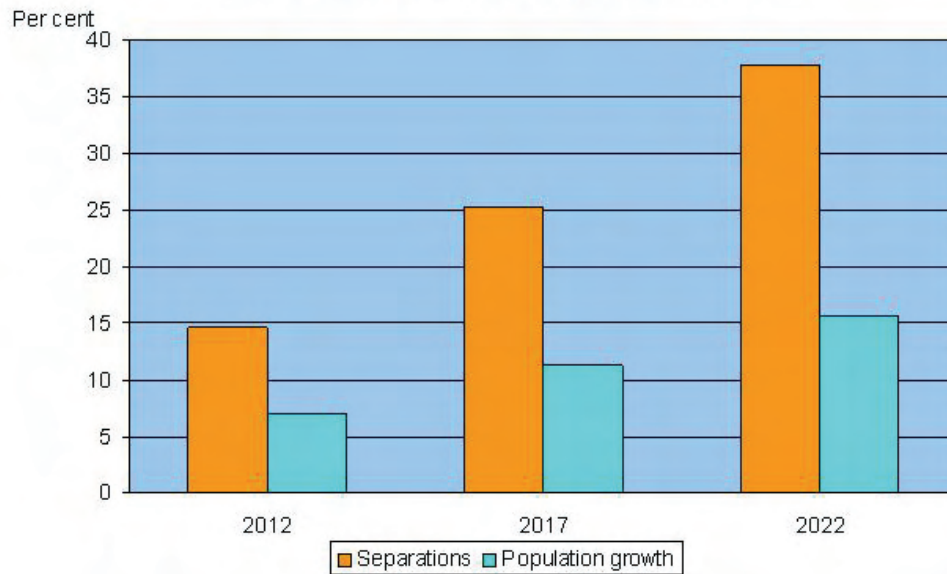

- 2.37 All of this highlights the huge challenge that is upon us as to how to meet increasing demand with finite resources.

Conclusion

- 2.38 I do not accept that the care provided in the public hospitals in NSW is disastrously bad, nor that it is at a level which is wholly inadequate in terms of safety and quality. On the contrary, I have formed a clear view that the level of health care provided in NSW and Australia is comparable with, if not better than, most of the first world and developed countries. By any world measure, Australia's healthcare is amongst the best. This fundamental attribute ought never be overlooked or forgotten.
- 2.39 That is not to say that the system in NSW is perfect, it is not. That is not to say that there are not areas for improvement. Clearly there are. It is also not meant to be a statement which overlooks those cases of which we all hear and read in the media of poor treatment and inadequate care.
- 2.40 But what it does mean is that one, when looking at the system as a whole, must try and place all of these things into some form of rational context. And that context in Australia and NSW is a very complex one. The size of the Department of Health, its reach, the geographical locations at which it provides healthcare to the citizens of NSW and the breadth and diversity of those services is very great indeed. In any discussion of healthcare in NSW, it is very easy to overlook these important matters of context.

A serious discussion

- 2.41 In Chapter 25, I have explained the critical funding shortages facing NSW public hospitals. It is not the case that the public of NSW can simply expect to be given appreciably more money from the state budget to meet the increasing demand for services and the increasing patient expectations, when regard is had to the many other important competing demands on the public purse.
- 2.42 To some extent, NSW public hospitals can make better use of the financial resources available, and I have discussed throughout my report various ways in which this can be

achieved. The funding contributions from the Commonwealth can and need to be supplemented. Beyond this, it seems to me that the time is rapidly approaching for NSW as a society to have an organised, comprehensive conversation about:

- (a) what we expect from our public health system,
- (b) what we are prepared to pay for through our taxes and other contributions, and
- (c) how to manage the increasing gap between the two.

2.43 As Diana Baird, a Registered Nurse at St Vincent's Hospital said during one of my public hearings:⁴¹

"We do have to start giving a bit of ownership to the public, to society, to the community [about] what they want, why they want it, how much they're prepared to pay for it."

Ms Baird made the point that a healthcare system in which every patient can exhaust all available treatment options is not sustainable.

2.44 A number of senior clinicians raised this issue during hearings and in submissions, and made some very confronting remarks which bear repetition.

2.45 Dr Andrew Munro, a staff specialist in emergency medicine at Coffs Harbour Hospital said that the hospital administration is under extreme pressure to continue to identify efficiencies and savings in an already stressed system in which we are failing to meet the needs of the community.⁴²

"I believe that as an emergency physician, I will before the end of my career be making decisions based on resource allocation and they will be life and death decisions."

2.46 Professor Peter van Asperen from the Children's Hospital at Westmead made the point that there are 2 solutions to address the increasing disparity between health service expectations and what the state can reasonably afford: either the health budget must be increased or we need to decide what services are essential to provide and what we can no longer support.⁴³ He highlighted the difficult nature of these decisions which must involve health professionals, the general public, and the government.⁴⁴

2.47 A number of senior doctors working with children and babies expressed real concern about proper funding for their patients being compromised by the increasingly aged patients in our hospitals. Dr Michael McGlynn, a plastic surgeon at the Sydney Children's Hospital, said that his hospital is struggling to compete with the huge increase in the need for aged care.⁴⁵ Similarly, Dr Michael Brydon, Director of Clinical Operations at the Sydney Children's Hospital said that:

"[T]he ageing population has the potential to dramatically crucify health spending in the next two decades. Unless the total allocation to health is dramatically enhanced, and this seems unlikely, then the shift of health expenditure towards the aged will undoubtedly compromise child health services...

"Treating an 8 year old child with a cardiac condition might gain us 50 years of a taxpayer. Treating an 80 year old with a heart condition might give us 5 more years of a pensioner payment. On economic grounds alone, it is a lay down misere that we must support child health. ...

"Rationing of health care is inevitable and I would hope that our communities expectations are sympathetic not to further compromise the health of the next generation when the cake is next cut."

End of life decisions

2.48 Whilst it is an extremely sensitive topic replete with ethical and cultural issues, the discussion needs to include consideration of how far NSW public hospitals should go in sustaining life. NSW Health already has policies in relation to this topic such as the guidelines for End-of-Life Care and Decision Making.⁴⁶ Individual area health services also provided me with draft strategic plans and policies in this regard.⁴⁷ On the other hand, I heard evidence that such policies are not well implemented, with the result that intensive care units can be choked with inappropriate admissions.⁴⁸

2.49 The discussion I am advocating needs to consider whether it is appropriate to exhaust all treatment options when that model of care is not only expensive but likely to be ineffective in extending a patient's life or improving the quality of that life. Dr Louis Christie, a specialist emergency physician and Director of Medical Services at Orange Hospital, encapsulated this point when he said:

"The community is going to have to engage in a fairly serious discussion about what treatment is provided to whom."⁴⁹

2.50 Dr Christie pointed out that treatment is becoming expensive and exhausting all treatment options for a patient is not only expensive but often futile.⁵⁰

2.51 Dr Judith Mary Branch, an anaesthetist and Visiting Medical Officer at St Vincent's Hospital made several remarks during her evidence about the difficult decisions confronting clinicians when deciding treatment options based on principles of resource allocation. She said:

"We have ethics committees who... decide whether patients are taken off life support [etc]... but we don't have committees who make the decision as to whether certain patients should be using resources that are available and that are expensive."⁵¹

Dr Branch gave the example of an 87 year old patient who had multiple co-morbidities but wanted an operation for a heart valve replacement to be done.⁵² The patient's risk of dying during the procedure was very high – he already had a totally blocked artery to his brain.⁵³

"At the same time as all this is being explained, the patients still demand that they get the same care as everybody else, because they've paid their taxes."⁵⁴

2.52 A doctor who has worked in NSW public hospitals since 1960 made some historical observations about resource allocation. He said that, in the 1960s,

"... [no one] over the age of 60 was put on a renal dialysis program or had a transplant. Now there is no cut-off age. People go on dialysis right up to their 90s. Renal transplants are performed in 70 year olds. In the 1960s and 70s, if you were over 70 you did not get a coronary artery graft where as now they are putting shunts and coronary bypass surgery... [on up to] 90 year olds. It is an incredible change in what we are offering in health care and the extent and complexity of health care."⁵⁵

2.53 A doctor at Westmead Hospital told me:

"There is an ever increasing capacity to provide an ever increasing array of interventions, often of marginal benefit but enormous cost. This has placed an increasing emphasis on cost and financial accountability (rightly so) but at the same time a commensurate increase in public expectation and absent leadership from politicians managing such expectations."⁵⁶

Appreciating the actual cost of services

2.54 A hindrance to the serious discussion which I am proposing is, it seems to me, that neither the public at large nor individual patients nor their families have any idea of the actual cost of the medical services and hospital care provided in NSW public hospitals. There is a general feeling that the services are free. Of course, the services are not free – it is simply that individual patients do not receive a bill but rather pay indirectly through the taxation system (or else benefit from the payments made by others).

2.55 Without seeking to pre-empt the outcome of discussion, may I point to some monetary examples to provoke thought. On average, its costs:

- \$90,675 to perform a heart transplant;⁵⁷
- \$13,589 to perform a hip replacement without complications;⁵⁸
- \$5,739 to treat a stroke without complications;⁵⁹
- \$11,074 to perform a heart pacemaker implantation;⁶⁰
- \$2,140 to perform a complex colonoscopy,⁶¹

in a NSW public hospital.

Recommendation 1: *NSW Health should consider whether in the interests of public education and information it would be feasible to provide to patients upon discharge from public hospitals either an itemised listing of the cost of their care based on the relevant case-mix formula or else to make publicly available the average cost of typical interventions and treatments.*

Conclusion

2.56 Is not for me for say what the conclusion to these questions, or else the end of the conversation, should be. This is a discussion which we as a society must have. In some ways, it is a discussion that politicians cannot drive without impressive leadership: politicians are answerable to their electorates and the pressure to provide all medical services demanded by their constituents is very strong. Nonetheless, the NSW Government can facilitate the discussion and should do so, in my view, sooner rather than later so that these issues can be comprehensively debated by all relevant stakeholders. It is only when we have some consensus, as a society, on how to balance public expectations with resources that we can ensure a public healthcare system which faces the challenges ahead with clarity and direction in a rational context.

Particular groups of patients

2.57 During the course of my Inquiry, I heard considerable evidence about particular groups of patients, whose care poses challenges to the NSW public hospital system. Some of these patient groups are not faring well in the system at present, and careful thought is

needed as to how we can treat these patients better, not just for the sake of these patient groups but because our inability to treat these patients well is impacting on the rest of the system.

2.58 I have discussed these patient groups in my report as follows:

- chronic and complex patients in Chapter 3,
- deteriorating patients in Chapter 19,
- elderly patients in Chapter 3,
- indigenous patients below,
- mothers in Chapter 4,
- non-English speaking patients below,
- babies, children and young people in Chapter 5; and
- people living in rural and regional NSW in Chapter 6.

Indigenous patients

2.59 There are about 148,200⁶² indigenous Australians living in NSW, a third of the nation's total indigenous population. Most (70%) live in rural or regional areas.

2.60 Indigenous health remains far worse than for non-indigenous people living in this state. Infant mortality amongst indigenous babies is markedly higher at 7.5 infants per 1,000 births⁶³ compared with 4.9 births per 1,000 for the non-indigenous population.⁶⁴ The rates of male Aboriginal suicide are 80% higher than non-Aboriginal rates.⁶⁵

2.61 To embark upon the important subject of indigenous health in this report would be, perhaps, foolhardy. It is the subject of much more learned study and detailed discussion than I have been able to achieve in the timeframe available to me, in conjunction with the wide range of other topics I have had to cover.

2.62 Suffice to say that I have visited several facilities which, and heard from health care workers who, principally serve indigenous communities and was impressed with the cohesiveness and quality of medical services offered, often in remote locations with all the additional challenge which that entails.

- At **Wilcannia**, I was told that the Aboriginal members of staff assist in identifying who in the community may need health care. As well, the hospital at Wilcannia provides transport for members of the local indigenous communities to and from the hospital because there is no public transport in the town. Unless this service is provided, then members of the community would miss out on the provision of necessary health care. The Maari Ma Aboriginal Medical Corporation also runs a local clinic 3 days a week and provides a bus service to Broken Hill 6 days a week to take people to and from medical appointments there. The service suffers from the lack of a local GP and problems recruiting nurses, but despite those difficulties, appeared to me to be doing an outstanding job in meeting the needs of the local community under difficult conditions.⁶⁶
- At **Bourke**, the indigenous population makes up about a third of the community. There is an indigenous liaison office in the Emergency Department, and there appeared to me to be a good relationship between the indigenous community, the aboriginal medical centre and the hospital.⁶⁷

- At **Walgett**, 65% of the population is indigenous. While the hospital provides medical assistance, Walgett Aboriginal Medical Service provides an impressive range of community support including sexual health education, clinical dental services and dental education, vision screening, ear screening and counselling. Walgett Aboriginal Medical Service employs some 40 casual and permanent staff, although finds it difficult to recruit GPs to the area.⁶⁸
- The **Wellington** Aboriginal Medical Corporation has 2.4 full time equivalent GPs and provides primary health care, screening programs, health promotion and prevention programs. It provides outreach services such as eye screening, transport services. It appeared to me to be a well organised service which has identified the needs of its community, and attempts to provide that community with all aspects of primary care.⁶⁹

- 2.63 Aboriginal Medical Services seemed to me to succeed in providing a relevant, comprehensive service to remote and indigenous communities, often in the same communities where NSW Health struggles to provide an equivalent service. In many cases, the Aboriginal Medical Service also provided good quality services to the non-indigenous population.
- 2.64 Beyond Broken Hill, one of the Aboriginal Medical Services, the Maari Ma Aboriginal Medical Corporation, actually operates medical services for NSW Health.⁷⁰ Under an agreement with the Greater Western Area Health Service, the Maari Ma Aboriginal Medical Corporation manage health services in Tibooburra, White Cliffs, Wilcannia, Broken Hill, Menindee, Ivanhoe, Pooncarie, Wentworth, Dareton, Euston and Balranald. Maari Ma Aboriginal Medical Corporation also provides a number of health programmes including:⁷¹
- a Chronic Disease Strategy, which endeavours to eliminate the onset of chronic illness by addressing diet, alcohol abuse and smoking,
 - the School Kids Health Check team, and
 - 11 alcohol clinics, delivered by a visiting specialist, focused on assessment, education and treatment plans,
- 2.65 In part, the ability of Aboriginal Medical Services to provide better service appears to be due to the fact that the Commonwealth Government provides substantial funding through a broad range of focussed programs. Indigenous health is something for which the Commonwealth Government is primarily responsible.⁷² However, in part also, it seemed to me that the excellence of the Aboriginal Medical Services was attributable to a greater degree of commitment to, understanding of and connection with their indigenous communities. I was impressed.
- 2.66 I also had some salutary reminders of wider issues that affect the provision of medical services to indigenous patients.
- (a) Unlike the rest of NSW, in Wilcannia I was told that there is no problem with a lack of aged care beds, due to the low life expectancy of the indigenous community.⁷³
 - (b) In Walgett, I visited the principal aboriginal residential areas and could clearly see how, as I was told, a lack of suitable housing is a major contributor to health problems. In one of the areas there were large numbers of people living in small, basically derelict houses, sometimes with as many as 13 people in one house.⁷⁴
 - (c) Whilst relations between the hospitals and indigenous communities appeared good in some communities, it is regrettable to note that there continued to be a difficult relationship in other areas. Staff at Wellington Aboriginal Medical Corporation discerned a lack of respect from hospitals with which they deal.⁷⁵

Staff at the Walgett Aboriginal Medical Service suggested that staff at the hospitals in which their patients were treated needed the benefit of some cultural awareness education.⁷⁶ I would certainly applaud any steps which addressed these shortcomings.

Issues pertinent to indigenous patients

- 2.67 There were a number of issues common to the NSW public hospital system which keenly affect indigenous patients. I have dealt with these issues in my report as follows:
- (a) Ceasing surgical services in smaller hospitals and requiring people to travel to larger centres for surgery particularly affects indigenous patients from remote areas. Aboriginal patients do not know the surgeon and are less likely to have the surgery. They may also be fearful of travelling to a larger centre for treatment. I have dealt with this in Chapter 6. The problems presently experienced in the transport provided for indigenous patients (and their relatives or carers) to travel from remote communities to and from a major hospital for treatment are dealt with in Chapter 6.
 - (b) The problems involved in discharging patients from hospital back to remote communities is dealt with in Chapter 28.
 - (c) The challenge of attracting staff to remote and rural communities is dealt with in Chapter 6.
 - (d) The difficulty of delivering health services in the vast areas comprised by the larger Area Health Services formed in 2004 is discussed in Chapter 31.

Indigenous infant and maternal health

- 2.68 Whilst NSW Health has issued many policies and strategies in relation to indigenous patients,⁷⁷ and the training of indigenous health professionals.⁷⁸ One is worthy of particular note here.
- 2.69 In 2001, NSW Health commenced the Aboriginal Maternal and Infant Health Strategy (**AMIHS**) to provide antenatal and post natal programs for Aboriginal women and infants across the Greater Western Area Health Service. Services were provided in the community and were embraced by indigenous women in preference to hospital based services as offering continuity of carer, less bureaucracy and being able to receive care in a familiar environment close to home.⁷⁹ Women in the program came in for earlier care. I was told that working with a midwife and an aboriginal health worker, in a collaborative, culturally sensitive, community based program, reduced prenatal mortality by reducing pre-term birth.⁸⁰ Of the women who received care from AMIHS, 11% of births were premature compared with 20% prior to the establishment of AMIHS.⁸¹
- 2.70 The Aboriginal Maternal and Infant Health Strategy presently has 46% penetration and sufficient funding to reach 100% of the NSW indigenous population.⁸²
- 2.71 I did receive some submissions which suggest that there is still work to be done to provide maternity services to indigenous women in a manner which is maximises the prospect of indigenous women wanting to avail themselves of the services.⁸³ It would certainly appear to be a continuing, and important, challenge to area health services with indigenous populations to pursue the types of strategies identified by the Aboriginal Maternal and Infant Health Strategy.

Non-English speaking patients

- 2.72 In some parts of NSW, there is a large proportion of the population who do not speak English well, or at all. It was suggested by way of an example, that about 25 to 30% of residents in western Sydney are born in a non-English speaking country and approximately 10% of people rate themselves as speaking English poorly or not at all.⁸⁴ In some local government areas of western Sydney, which have had the highest refugee and humanitarian migrant intake of the state over the last 3 years,⁸⁵ the proportion of residents who speak a language other than English at home is closer to 60%.⁸⁶
- 2.73 During my visit to Liverpool Hospital, I was told that about 40% of the 59,000 people presenting to the Emergency Department have no, or very little, English. (The on-site interpreting service was said to be very good.)
- 2.74 Language problems place an additional workload on hospital staff in obtaining information from the patient about their condition, and getting informed consent to medical treatment.
- (a) Dr Miriam Levy, a Gastroenterologist at Liverpool Hospital, said that it takes twice or 3 times as long to obtain a consent from a non-English speaking patient and this increases the workload for junior medical staff.⁸⁷ As well, it takes time to identify the need for an interpreter and obtain one for patients in a ward which has the consequence that commencement of appropriate treatment may be delayed.⁸⁸
- (b) A survey conducted by the Medical Staff Council at Liverpool Hospital confirmed that a culturally and linguistically diverse population was considered to increase workload per patient due to the increased time needed to overcome communication problems.⁸⁹
- 2.75 Professional healthcare interpreters are provided to assist in such cases. Interpreters attend in person, or can provide a telephone service.⁹⁰
- 2.76 Clarissa Mulas, Network Director of the Multicultural Health Network, said that in Sydney West Area Health Service, to provide interpreters more rapidly, a 24-hour call centre model is used which has an improved response rate:⁹¹ the call centre can assess whether an urgent response is required, in which case the call centre endeavours to source a telephone interpreter for the patient.⁹² In other cases, health trained interpreters are found.
- 2.77 However, Ms Mulas reported that only 60% of requests for interpreters at admission are met in the Sydney West Area Health Service, that is, for all patients who tick the box “interpreter required” on their admission form, interpreters are provided 60% of the time. Further, patients were often provided with an interpreter on one occasion but not another.⁹³ Family members are still regularly used as interpreters, which is against government policy.⁹⁴
- 2.78 I also heard a number of contrasting views about interpreter services: I was told that many days notice were required to set up a meeting with an interpreter.⁹⁵ Interpreters were booked centrally through the area health service and had to travel from one site to another, causing inefficiency.⁹⁶
- 2.79 Ms Mulas said that improved access to hands free telephone services was needed in many hospitals to assist in the utilisation of telephone interpreter services.⁹⁷ Ms Mulas

observed that in a culturally and linguistically diverse society, these improvements should not be thought of as an “add-on” but be at the heart of the design.⁹⁸

Recommendation 2: *In order to improve the availability of interpreting services in public hospitals for non-English speaking patients, each Area Health Service must investigate the sufficiency of, and ensure the adequacy of, the hands free communication equipment available in each hospital to maximise the opportunities for the use of the telephone interpreter service.*

- ¹ Australian Bureau of Statistics, *Year Book Australia, 2008*, 2008, ABS, Canberra, <http://www.abs.gov.au/ausstats/abs@.nsf/bb8db737e2af84b8ca2571780015701e/8826A00C209DDB02CA2573D200106A75?opendocument> (29 September 2008).
- ² Australian Bureau of Statistics, *Year Book Australia, 2008*, 2008, ABS, Canberra, <http://www.abs.gov.au/ausstats/abs@.nsf/bb8db737e2af84b8ca2571780015701e/8826A00C209DDB02CA2573D200106A75?opendocument> (29 September 2008).
- ³ Australian Bureau of Statistics, *Australian Demographic Statistics*, 2008, ABS, Canberra, 3101.0, <http://www.abs.gov.au/ausstats/abs@.nsf/mf/3101.0> (29 September 2008).
- ⁴ Australian Bureau of Statistics, *Australian Demographic Statistics*, 2008, ABS, Canberra, 3101.0, <http://www.abs.gov.au/ausstats/abs@.nsf/mf/3101.0> (29 September 2008).
- ⁵ Australian Bureau of Statistics, *Australian Demographic Statistics*, 2008, ABS, Canberra, 3101.0, <http://www.abs.gov.au/ausstats/abs@.nsf/mf/3101.0> (29 September 2008).
- ⁶ Australian Bureau of Statistics, *Year Book Australia, 2008*, 2008, ABS, Canberra, 1301.0, <http://www.abs.gov.au/ausstats/abs@.nsf/bb8db737e2af84b8ca2571780015701e/5A717784C2562A99CA2573D20010FF17?opendocument> (29 September 2008).
- ⁷ At birth for 2005, NSW Health, *Annual Report 2006/07*, 2007, NSW Health, North Sydney p. 21 cf letter from NSW Health to Special Commission of Inquiry, 12 February 2008.
- ⁸ At birth for 2005, NSW Health, *Annual Report 2006/07*, 2007, NSW Health, North Sydney p. 21 cf letter from NSW Health to Special Commission of Inquiry, 12 February 2008.
- ⁹ NSW Health, *Annual Report 2006/07*, 2007, NSW Health, North Sydney p 21; Male life expectancy ranks 5th behind Japan, Switzerland and Iceland and Hong Kong. Organisation for Economic Cooperation and Development (OECD), *Health at a Glance*, 2007, Paris, p. 21; cf letter from NSW Health to Special Commission of Inquiry, 12 February 2008. Female life expectancy ranks 6th behind Japan, Hong Kong, Switzerland, Spain and France. letter from NSW Health to Special Commission of Inquiry, 12 February 2008..
- ¹⁰ NSW Health, *Annual Report 2006/07*, 2007, NSW Health, North Sydney p 21 cf letter from NSW Health to Special Commission of Inquiry, 12 February 2008.
- ¹¹ NSW Health briefing, 2 July 2008, transcript 52.33.
- ¹² Australian Bureau of Statistics, *Australian Social Trends, 2004*, 2004, <http://www.abs.gov.au/ausstats/abs@.nsf/1020492cfc63696ca2568a1002477b5/47f151c90ade4c73ca256e9e001f8973!OpenDocument> (9 October 2008).
- ¹³ NSW Health briefing, 13 March 2008, transcript 41.35-42.08 (TRAN.054.0001).
- ¹⁴ NSW Health briefing, 13 March 2008, transcript 41.35-42.08 (TRAN.054.0001).
- ¹⁵ Australian Bureau of Statistics, *Year Book Australia, 2008*, 2008, ABS, Canberra, 3101.0 <http://www.abs.gov.au/AUSSTATS/abs@.nsf/bb8db737e2af84b8ca2571780015701e/72097B9A70C71596CA2573D20010FD0A?opendocument> (29 September 2008).
- ¹⁶ 42.9% in 1997-1998; Nichol B, Lonergan J and Mould M, DRG Development Section, Acute and Coordinated Care Branch, Commonwealth Department of Health and Aged Care, *The Use of Hospitals by Older People: a Casemix Analysis*, Occasional Papers: New Series No. 11 (2000) Commonwealth Department of Health and Aged Care, Canberra p. 9; 44% in 2006; Email from NSW Health to Special Commission of Inquiry, 6 February 2008.
- ¹⁷ NSW Health *Analysis of Emergency Admission Data Discussion Paper: Release 1.0*, 2007, NSW Health, North Sydney, p 37. (DOH.024.0316). I note that the total number of Emergency Department Attendances in the 2005/2006 financial year reported in the discussion paper conflict with the total for that year provided in NSW Health’s 2006/2007 Annual Report which reported a total of 2,195,115 Emergency Department attendances in

2005/2006. NSW Health reports that this discrepancy is due to the discussion paper containing data from only 51 NSW Emergency Departments. NSW Health confirms that the total figure reported in its 2006/2007 Annual Report represents the true reflection of Emergency Department attendances for that year.

- 18 NSW Health, *Annual Report 2006/07*, 2007, NSW Health, North Sydney p 241.
- 19 NSW Health, *Analysis of Emergency Admission Data Discussion Paper: Release 1.0*, 2007, NSW Health, North Sydney, p 46.
- 20 Australian Institute of Health and Welfare, *The Burden of Disease and Injury in Australia 2003, 2007*, Canberra, p 107. <http://www.aihw.gov.au/publications/index.cfm/title/10317> (30 September 2008)
- 21 Australian Institute of Health and Welfare, *The Burden of Disease and Injury in Australia 2003, 2007*, Canberra, p 122. <http://www.aihw.gov.au/publications/index.cfm/title/10317> (30 September 2008)
- 22 Australian Institute of Health and Welfare, *The Burden of Disease and Injury in Australia 2003, 2007*, Canberra, p 122. <http://www.aihw.gov.au/publications/index.cfm/title/10317> (30 September 2008)
- 23 Productivity Commission, *Impacts of Advances in Medical Technology in Australia*, Research Report, 2005, Productivity Commission, Melbourne p xxvii.
- 24 Llinas, R.H, "Acute Ischemic Stroke Treatment", (2006) *US Neurological Disease*, p 35-37.
- 25 Llinas, R.H, "Acute Ischemic Stroke Treatment", (2006) *US Neurological Disease*, p 35-37.
- 26 Llinas, R.H, "Acute Ischemic Stroke Treatment", (2006) *US Neurological Disease*, p 35-37.
- 27 Llinas, R.H, "Acute Ischemic Stroke Treatment", (2006) *US Neurological Disease*, p 35-37.
- 28 NSW Health briefing, 13 March 2008, transcript 43.24-28.
- 29 NSW Health briefing, 13 March 2008, transcript 43.24-28.
- 30 NSW Health briefing, 11 February 2008.
- 31 NSW Health briefing, 22 May 2008, transcript 77.05.
- 32 Health Care Complaints Commission, *Annual Report 2006-07*, Health Care Complaints Commission, Sydney, p. 23.
- 33 Health Care Complaints Commission, *Annual Report 2006/07*, Health Care Complaints Commission, Sydney p. 131.
- 34 NSW Health, *Health Facts*, 2008, NSW Health, North Sydney, p. 1; 2005/06 saw 1.409 million hospital admissions: NSW Health, *Annual Report 2006/07*, 2007, NSW Health, North Sydney p 25. (REP.003.0542)
- 35 NSW Health, *Annual Report 2006/07*, 2007, NSW Health, North Sydney p 25. (REP.003.0542)
- 36 Letter from NSW Health to Special Commission of Inquiry, 7 November 2008.
- 37 Letter from NSW Health to Special Commission of Inquiry, 7 November 2008.
- 38 Population of NSW in Dec 2002: 6,649,460; Population of NSW in Dec 2006: 6,854,067. Australian Bureau of Statistics, *Australian Demographic Statistics*, 2008, ABS, Canberra, 3101.0, [http://www.ausstats.abs.gov.au/ausstats/ABS@Archive.nsf/0/1F85ED324CC793FDCA2574CD0012942A/\\$File/310104.xls#A2060843J](http://www.ausstats.abs.gov.au/ausstats/ABS@Archive.nsf/0/1F85ED324CC793FDCA2574CD0012942A/$File/310104.xls#A2060843J).
- 39 NSW Health briefing, 13 March 2008, transcript 8.35 –9.42 cf NSW Health, *Annual Report 2006/07*, NSW Health, North Sydney, NSW Health, *Annual Report 2004/05*, NSW Health, North Sydney.
- 40 NSW Health briefing, 13 March 2008, transcript 8.45
- 41 Dianna Baird, St Vincent's Hospital hearing, 30 April 2008, transcript 2504.07.
- 42 Dr Andrew Munro, Coffs Harbour hearing, 27 March 2008, transcript 978.31.
- 43 Professor Peter Van Asperen, Sydney Children's Hospital at Westmead hearing, 15 May 2008, transcript 2979.35.
- 44 Professor Peter Van Asperen, Sydney Children's Hospital at Westmead hearing, 15 May 2008, transcript 2979.44 (TRAN.117.0001).

-
- 45 Dr Michael McGlynn, Sydney Children's Hospital hearing, 19 May 2008, Transcript 3089.36 (TRAN.101.0099)
- 46 NSW Health, *End-of-life Care and Decision-Making – Guidelines*, GL2005_057. http://www.health.nsw.gov.au/policies/gl/2005/GL2005_057.html (1 October 2008).
- 47 Sydney West Area Health Service's Draft End of Life Care Planning & Decision Making – Strategic Plan 2008-2010 and their Draft Advanced Medical Directives Policy for Acute Care Facilities, Sydney West Area Health Service, 2008.
- 48 Dr Sundaram Rochkondo, Liverpool hearing, 17 April 2008, transcript 1813.22.
- 49 Dr Louise Christie, Orange hearing, 18 March 2008, transcript 546.38. (
- 50 Dr Louis Christie, Orange hearing, 18 March 2008, transcript 548.1-2.
- 51 Dr Judith Branch, St Vincent's Hospital hearing, 30 April 2008, transcript 2469.12.
- 52 Dr Judith Branch, St Vincent's Hospital hearing, 30 April 2008, transcript 2469.23.
- 53 Dr Judith Branch, St Vincent's Hospital hearing, 30 April 2008, transcript 2469.27.
- 54 Dr Judith Branch, St Vincent's Hospital hearing, 30 April 2008, transcript 2469.28.
- 55 Confidential Sydney Children's Hospital hearing, 19 May 2008, transcript 20.07.
- 56 Confidential submission, 11 June 2008, SUBM.077.0198.
- 57 NSW Health, *NSW Costs of Care Standards 2006/2007*, GL2005_071.
- 58 NSW Health, *NSW Costs of Care Standards 2006/2007*, GL2005_071.
- 59 NSW Health, *NSW Costs of Care Standards 2006/2007*, GL2005_071.
- 60 NSW Health, *NSW Costs of Care Standards 2006/2007*, GL2005_071.
- 61 NSW Health, *NSW Costs of Care Standards 2006/2007*, GL2005_071.
- 62 Australian Bureau Statistics, *National Aboriginal and Torres Strait Islander Statistics*, <http://www.abs.gov.au/AUSSTATS/abs@.nsf/39433889d406eeb9ca2570610019e9a5/f89b794eb0b05933ca2574660010e896!OpenDocument> (17 June 2008)
- 63 Steering Committee for the Review of Government Service Provision, *Report on Government Services 2008*, Volume 2, p. E.28, 2008, Productivity Commission, Melbourne for 2005-06 figures; cf letter from NSW Health to Special Commission of Inquiry, 12 February 2008.
- 64 The infant mortality rate in NSW is 4.9 births per 1,000 (2005), which is slightly better than the Australian infant mortality rate of 5 births per 1,000, or the average OECD rate of 5.4 births per 1,000. NSW Health, *Annual Report 2006/07* NSW Health, North Sydney p. 22. Compared to other OECD countries, however, Australia ranks only 20 out of 30 countries: Organisation for Economic Cooperation and Development (OECD), *Health at a Glance*, 2007, Paris, p. 35.
- 65 NSW Health, *Aboriginal information and support needs assessment for families and carers, AFACT (Aboriginal Families and Carers Training) – Stage One, 2007*, NSW Health http://www.health.nsw.gov.au/pubs/2007/afact_report.html (13 November 2008).
- 66 Information provided during visit to Wilcannia Health Service, 8 May 2008.
- 67 Information provided during visit to Bourke District Hospital, 8 May 2008.
- 68 Information provided during visit to Walgett Aboriginal Medical Service Co-Operative Ltd, 9 May 2008
- 69 Information provided during visit to the Wellington Aboriginal Medical Corporation, 18 March 2008.
- 70 Maari Ma Health Aboriginal Corporation, *2007 Annual Report*, 2007, Maari Ma Health Aboriginal Corporation, Broken Hill.
- 71 Submission of Maari Ma health Aboriginal Corporation - 2007 Annual Report. (SUBM.078.0274)
- 72 Commonwealth Government, *Department of Health and Ageing/Annual Report 2007-2008, Outcome 8 Indigenous Health* <http://www.health.gov.au/internet/main/publishing.nsf/Content/annual-report2007.htm> (13 November 2008).
- 73 Information provided during visit to Wilcannia Health Service 8 May 2008.

-
- ⁷⁴ Information provided during visit to Walgett Aboriginal Medical co-Operative Ltd, Service 9 May 2008.
- ⁷⁵ Information provided during visit to Wellington Aboriginal Medical Corporation, 18 March 2008.
- ⁷⁶ Information provided during visit to Walgett Aboriginal Medical co-Operative Ltd, Service 9 May 2008.
- ⁷⁷ Meeting with NSW Health, 31 March 2008.
- ⁷⁸ Meeting with NSW Health, 31 March 2008, 4 April 2008.
- ⁷⁹ Submission of Pamela Bennett, 1 April 2008. (SUBM.035.0208)
- ⁸⁰ Dr Hannah Dahlen Sally Tracey, Sydney Children's Hospital hearing 19 May (2008), Pg 2037.
- ⁸¹ NSW Health, *NSW Aboriginal, Maternal and Infant Health Strategy Evaluation Final Report*, 2005, NSW Health, North Sydney, p. 26.
- ⁸² NSW Health Briefing, 31 March 2008, transcript 60.25-27.
- ⁸³ Submission of Allan Kerrigan, Greater Western Area Health Service Clinical Networks Briefing Paper, 18 March 2008.
- ⁸⁴ Clarisa Mulas, Westmead Hospital hearing, 26 May 2008, transcript 3185.02.
- ⁸⁵ Clarisa Mulas, Westmead Hospital hearing, 26 May 2008, transcript 3185.20.
- ⁸⁶ Clarisa Veronica Mulas, Westmead Hospital Sydney hearing, 26 May 2008, transcript 3185.18.
- ⁸⁷ Dr Miriam Levey, Liverpool hearing, 17 April 2008, transcript 1897.32.
- ⁸⁸ Dr Miriam Levey, Liverpool hearing, 17 April 2008, transcript 1897.42.
- ⁸⁹ Dr Peter Collett, Liverpool hearing, 17 April 2008, transcript 1816.44.
- ⁹⁰ Clarisa Veronica Mulas, Westmead hearing, 26 May 2008, transcript 3185.40.
- ⁹¹ Clarisa Mulas, Westmead Hospital hearing, 26 May 2008, transcript 3188.14.
- ⁹² Clarisa Mulas, Westmead Hospital hearing, 26 May 2008, transcript 3188.14.
- ⁹³ Clarisa Mulas, Westmead Hospital hearing, 26 May 2008, transcript 3187.43.
- ⁹⁴ Clarisa Mulas, Westmead Hospital hearing, 26 May 2008, transcript 3186.32.
- ⁹⁵ Sonja Khatri, Concord hearing, 24 April 2008, transcript 2135.45.
- ⁹⁶ Sonja Khatri, Concord hearing, 24 April 2008, transcript 2136.01.
- ⁹⁷ Clarisa Mulas, Westmead Hospital hearing, 26 May 2008, transcript 3189.38.
- ⁹⁸ Clarisa Mulas, Westmead Hospital hearing, 26 May 2008, transcript 3189.34.

3 Chronic, complex & elderly patients

Chronic and complex patients	40
Co-ordination of treatment	41
Treatment outside hospital	50
Elderly patients	54
Unnecessary delays in discharge.....	57
Treating elderly patients more smartly	61
Pressing workforce issues	65
Lack of psychogeriatric beds	67
Importance of Electronic Medical Record	68

Chronic and complex patients

- 3.1 Chronic disease is defined as a condition that usually has a gradual onset (although it can have sudden onset and acute stages), is long term and persistent and leads to a progressive deterioration of health, typically compromising quality of life through physical limitations and disability.¹ While usually not immediately life threatening, chronic disease is the most common and leading cause of premature mortality.²
- 3.2 The chronic conditions and diseases that have a large impact on the health and quality of life of Australians are: coronary heart disease, stroke, lung cancer, colorectal cancer, depression, diabetes, asthma, chronic obstructive pulmonary disease, chronic kidney disease, oral diseases, arthritis and osteoporosis.³
- 3.3 Chronic disease can occur across the life cycle although it is more prevalent with older age. It is estimated that 3% of the Australian population (that is, around 600,000 people) have complex chronic disease, the majority of whom are over 65 years of age.
- 3.4 In New South Wales, approximately 932,000 of the population are aged 65 and over.⁴ The Inquiry was informed that 2.3% of that population, or 22,000 people, are at a very high risk of experiencing an acute event and need help in the coordination of their care.⁵ 14.7 % (138,000) are at high risk of experiencing an acute event.⁶
- 3.5 “Very high risk” patients include those who, variously, have 4 or more active long term conditions, are classified as “frail elderly”, are cognitively impaired, living alone, medically unstable or have high intensity social care needs.⁷ Those classified as “high risk” include those who have one or more chronic conditions, who recently experienced a major health event or often need pain management or those who frequently attend the Emergency Department for care.⁸ These two categories of patient represent a significant proportion of the chronic and complex disease burden in NSW.
- 3.6 In Australia chronic disease reportedly accounts for around 80% of the total disease burden, and its management accounts for 70% of all current health expenditure.⁹
- 3.7 Information provided to the Inquiry indicates that an estimated 77% of NSW residents (more than 4.8 million people) live with at least one chronic disease, and half die from a chronic disease.¹⁰ These deaths are in the main associated with only 9 chronic illnesses: congestive heart failure, chronic lung disease, cancer, coronary artery disease, renal failure, peripheral vascular disease, diabetes, chronic liver disease and dementia.¹¹
- 3.8 Patients with **complex** chronic disease have serious health conditions which give rise to high levels of health care need.¹² Typically, patients with complex chronic disease are among the heaviest users of health and community services, with multiple presentations to the Emergency Department and hospital admissions, longer stays in hospitals and frequent visits to general practitioners and specialists.¹³
- 3.9 The Australian Health Policy Institute told the Inquiry that one of the reasons that public hospital beds are so hard to access is because they are occupied by patients with chronic problems who often present to hospital with one problem, are found to have several during their stay, and then occupy the bed for several days.¹⁴ Other witnesses agreed with this assessment. Dr Miskell, Director of Medical Services at Royal North Shore Hospital submitted to the Inquiry that:

“Acute care hospitals in NSW are currently collapsing under the weight of patient demand, in particular the demand of patients with chronic complex conditions presenting to emergency departments. This, I believe, is

due to the failure of primary healthcare management of these patients.”¹⁵

- 3.10 There are 2 key strategies to be pursued in relation to chronic and complex patients:
- (a) better co-ordinating the treatment of these patients within the hospital system; and
 - (b) where possible, treating these patients outside the hospital environment.
- 3.11 As NSW Health informed the Inquiry, there is currently insufficient coordination of care when it comes to patients with chronic disease:

“Most patients with chronic disease are treated on an episodic basis by specialist doctors and general practitioners with there being insufficient coordination of patient care. Whilst chronic disease remains insufficiently managed, older patients will continue to present at Emergency Departments and hospitals at a rate that the health system will not be able to sustain.”¹⁶

- 3.12 Other issues which particularly impact on chronic and complex patients are discussed elsewhere in my report as follows:
- (a) The need for communication between a large number of health professionals treating the patient – see Chapter 15;
 - (b) The need for integrated Electronic Medical Records in NSW public hospitals, GPs and community health – see Chapter 14;
 - (c) Better models of care to treat chronic and complex patients in the Emergency Department, including through use of Medical Assessment Units – see Chapter 20;
 - (d) Treatment of chronic and complex patients through community health services – see Chapter 21;
 - (e) Where such patients are elderly, as is often the case, I have also discussed different models of care for better treatment later in this chapter;
 - (f) Transfer of care of complex paediatric patients to the adult setting – see Chapter 5; and
 - (g) The ongoing care of patients severely afflicted by brain damage or physical disability, but who are too young to qualify for an aged care bed – see Chapter 28.

Co-ordination of treatment

- 3.13 Given the increasing specialisation of medical practice, a patient with a number of different illnesses may have several medical teams looking after them. This can lead to several problems, in particular:
- (a) lack of co-ordination between medical teams;
 - (b) potentially conflicting treatment regimes;
 - (c) some medical problems falling between the gaps of the specialist medical teams; and
 - (d) no one taking overall responsibility for the patient.
- 3.14 The problem is compounded by the present lack of general physicians in NSW public hospitals, discussed further in Chapter 7.

- 3.15 The Westmead Medical Staff Council submitted that one of the contributing factors is the development of sub-specialties, with a smaller number of generally trained consultants and senior registrars wishing to take overall responsibility of complex patient care:¹⁷

"This is in fact the Achilles' heel of the evolution of task delegation ... that appears to be the panacea which is repeatedly put forward as the solution to the public health system's complex organisational problems; for every specialised role ..., an experienced co-ordinator with all-round general medical/surgical knowledge is required to ensure the complex patient doesn't fall through the cracks separating the task specific health workers."

- 3.16 The Westmead Medical Staff Council suggests that one solution is a structural reorganisation that promotes truly patient-focussed multidisciplinary coordinated models of care. An example put forward is the Older Persons Evaluation, Review and Assessment program (**OPERA**), the features of which I discuss further below in the section on elderly patients.¹⁸

- 3.17 As Mr Grant, a clinical nurse specialist at Liverpool Hospital submitted to the Inquiry, a patient with co-morbidities will have a number of medical teams looking after him or her.¹⁹ This sometimes leads to conflicting treatment regimes and an uncertainty as to who has overall responsibility for the patient.²⁰ This problem is compounded by a general shortage of medical specialists in the hospital. Some patients fall through the gaps in the specialties.²¹ Mr Grant's view was that these patients could be more comprehensively cared for under a general physician.²² To a similar effect, Dr Brydon of Sydney Children's Hospital submitted that:²³

"Sadly, there has been a significant shift away from the role of general physicians in adult medicine. The overall coordination of care for many complex adult patients is gravely lacking until one reaches the ripe old age range allocated to geriatricians."

- 3.18 The Australian Health Policy Institute informed the Inquiry that a major issue in health relates to the care of patients requiring access to multiple services, some of which are provided by the State, some by the Commonwealth, and some privately.²⁴ I was told that it is very difficult to bring these together in an effective relationship.²⁵ People with chronic illness need continuity of care.²⁶ This indicates a need for health care providers who can manage the care of such patients across the system.²⁷

- 3.19 A number of models of care have been introduced to better coordinate the care of patients with chronic disease. These models are characterised by a coordinated 'care management approach' for patients and an increase in the care provided in non-acute settings. These initiatives have generally been confined to specific geographical areas and generally focus on only one type of chronic condition.

NSW Chronic Care Program

- 3.20 NSW Health²⁸ and the Sustainable Access Health Priority Taskforce²⁹ briefed the Inquiry about efforts that are being made to deliver better patient journeys for older people and those with chronic disease on a system-wide basis. NSW Health acknowledges that these groups of patients are best managed in the community with all necessary support services, unless they are acutely ill.³⁰
- 3.21 NSW Health established the "NSW Chronic Care Program" in 2000 to improve services for people with chronic illness. The Chronic Care Program is now in its third phase.

Phases 1 and 2 were carried out in the years 2000-2003 and 2003-2006 respectively.³¹ NSW Health provided the Inquiry with documents outlining the aims, initiatives and achievements of the program.

- 3.22 The program is based on the recognition that:
- effective patient-centred care for patients with chronic illness is predicated on managing the needs of the individual patient across their care continuum, rather than on managing a specific medical condition;
 - patient-centred care requires GP and community-based teams to have effective links with hospitals and specialist services, ensuring appropriate access to acute services when required, and fostering an ongoing coordinated team approach to patient care.³²
- 3.23 NSW Health acknowledges that the coordinated care programs that have been developed in NSW are confined to special geographic areas and generally focus on only one type of chronic condition and that there is a need for a state-wide approach to supporting patients with severe chronic disease.³³ Proposed phase 4 of the NSW Chronic Care Program includes NSW Health's Severe Chronic Disease Management Program (**SCDM Program**), which seeks to address this need.³⁴ Phase 4 also includes projects relating to:
- Mental health as a co-morbidity in chronic disease;
 - The provision of information related to transition into residential aged care or living in the community with support services;
 - Advance Care Planning and end of life management;
 - Aboriginal Chronic Disease Management.

Severe Chronic Disease Management Program

- 3.24 NSW Health outlined for the Inquiry its proposal for a State-wide program, the SCDM Program. The SCDM Program is at proposal stage only. NSW Health informed the Inquiry that funding is yet to be identified for allocation to the SCDM Program and that an implementation plan for the program will only be developed once this has happened.³⁵
- 3.25 The SCDM Program has been developed as a state-wide initiative to coordinate the delivery of specialist medical, acute hospital, general practice and community health services to patients aged 65 and over, and Aboriginal patients aged 45 and over, who are at high or very high risk of experiencing an acute event as a result of their chronic condition. It will also relate only to 5 chronic diseases: diabetes, congestive heart failure, coronary artery disease, chronic obstructive pulmonary disease and hypertension.³⁶
- 3.26 The 4 components of the program are:³⁷
- Enrolment of eligible patients with a new Chronic Care Service (**CCS**) in each area health service;
 - The development of a 'shared care plan' for each patient informed by a comprehensive health assessment and evidence-based treatment protocols;
 - Care co-ordinators or health coaches working largely by telephone to support patient (and carer) self-management and to co-ordinate and monitor implementation of each patient's shared care plan. This includes brokering care services as necessary and co-ordination with care providers, for example, medical specialists, GPs, community pharmacists, nurses, carers and allied health professionals; and

- Integrated information and communication systems that support clinical decision making, centralise collection of information and allow secure sharing and information across services and sectors.
- 3.27 The role of the Chronic Care Service would be to receive “inbound” calls and referrals, enrol patients in accordance with state-wide protocols, provide patients and clinicians with information and deliver “outbound” health coaching and care coordination. The Chronic Care Services would also coordinate existing area health service chronic disease programs. I was told that Chronic Care Services would be established as a joint venture with the relevant Division of General Practice.
- 3.28 I was told that there will be multiple pathways to Chronic Care Services, with eligibility for enrolment in the SCDM Program determined by clinicians attached to the Chronic Care Service (based on information from GP assessments and other sources), including:
- referral by Emergency Departments and other acute services;
 - referral by GPs;
 - referral by other clinicians in the community; and
 - self-referral or referral by a carer.
- 3.29 It is envisaged that the National Health Call Centre Network and other call centres would transfer calls to the relevant Chronic Care Service where appropriate.
- 3.30 The Inquiry was informed that the SCDM Program recognises that the patient-GP relationship is at the heart of medical care for older people with severe chronic disease.³⁸ The SCDM Program seeks to provide additional support to GPs in managing the care of their patients.³⁹ Indeed it is intended that GP Divisions will be joint partners in the governance of the Program.
- 3.31 The Inquiry was told that a State-wide Joint Governance Committee and a new Chronic Disease Management Office located in the Department of Health will be established to develop state-wide models of care, state-wide standard IT and extensive data analytics capabilities.
- 3.32 In my view, the model of care which the above system envisages, namely a care plan approach for patients suffering from chronic disease and the allocation of a single care coordinator who manages his or her care, in conjunction with a GP, is to be favoured. Of course, the degree of involvement of the care coordinator in brokering the patient’s care will vary depending on the patient’s conditions.
- 3.33 An overriding issue relates to the need for adequate governance processes to be in place, including for clinical and managerial overview of the Program and quality improvement. This is an important issues which requires detailed attention by NSW Health in close consultation with clinicians.

Whole of system reform

- 3.34 In its submission to the Inquiry, NSW Health stated that:⁴⁰
- “The challenge is to keep the elderly and people with chronic disease safely supported in their familiar home and community environment. To do this, early detection and treatment of conditions is required to avoid deterioration and emergency hospitalisation. Should hospitalisation be required for these patients, the focus needs to be on well organised management of their long-

term health rather than just fixing immediate symptoms, particularly across the acute/primary care interface.

Improvements for these patients rely on better partnerships between GPs, community health providers, hospitals and nursing homes. The current increasing burden of chronic disease as the population ages has meant that the need for a more comprehensive and consistent approach is now urgent."

3.35 The following diagram represents how NSW Health traditionally delivers to patients:⁴¹

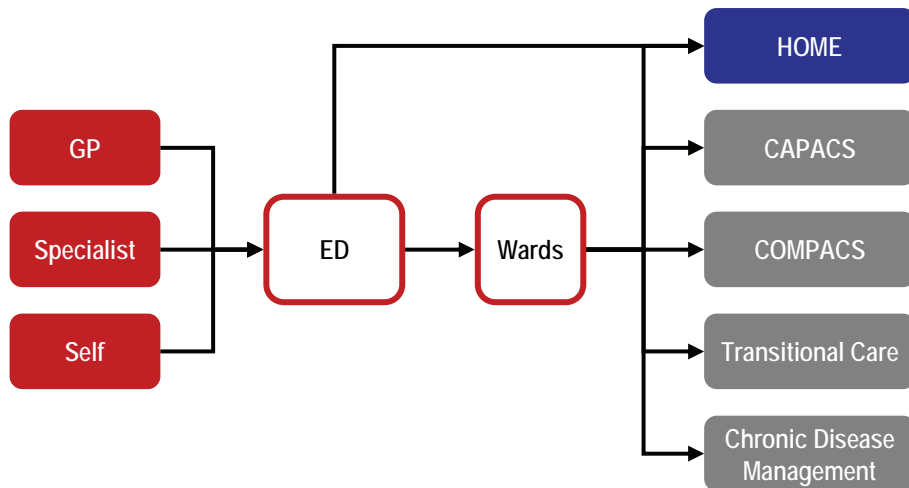

3.36 There has been recognition that a new model for access to care needs to be developed and this has resulted in the below model being preferred:⁴²

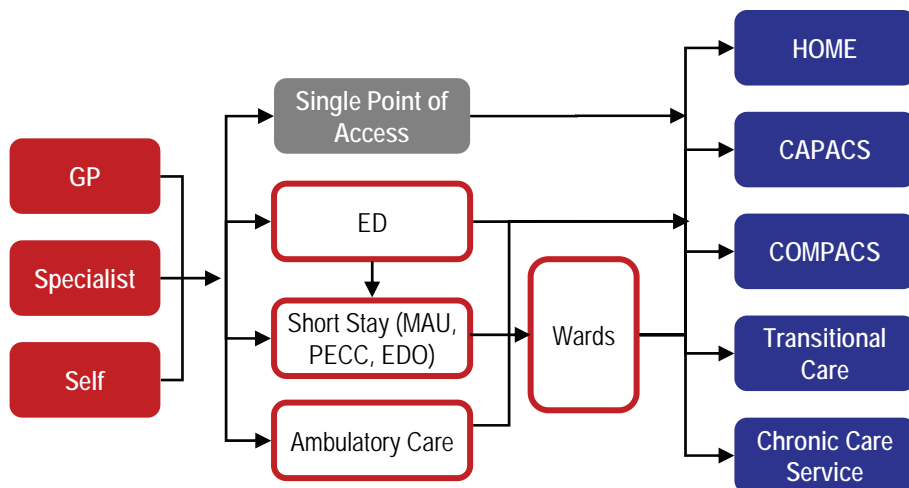

3.37 The Sustainable Access Health Priority Taskforce informed the Inquiry that strategies to appropriately deal with elderly, chronic and complex patients must, and in some areas already do, address the following 4 elements:⁴³

- (a) Making it easier to access community health services by having a single point of access.
- (b) Avoiding hospitalisation by ensuring patients receive appropriate care at home and in the community. There are 3 elements to this:

- (i) Community Acute/Post Acute Care (CAPAC) - under the program, patients receive acute care services in their home environment rather than hospital. I discuss CAPAC in Chapter 21;
 - (ii) Chronic disease care planning, which requires GPs to detect the patient's care needs and create a treatment plan for them; and
 - (iii) Rehabilitation for chronic disease - Enabling self management of a chronic condition or effective long term case management in a community setting. NSW Health has endorsed a model of care for the rehabilitation of chronic disease. The area health services are expected to implement that model of care. To manage the implementation of chronic disease rehabilitation NSW Health has created key performance indicators to provide evidence of increased referral and participation rates to chronic disease rehabilitation services.⁴⁴
- (c) Faster treatment in the Emergency Department or alternate diagnostic and management centres in hospitals, such as Medical Assessment Units, that can treat complex elderly patients and those with chronic disease.
- (d) Ensuring that if hospitalisation is required the treatment is well coordinated so that the patient can safely return to a home environment as soon as possible. This requires an appropriate system for ensuring discharge from hospital, including establishment of an estimated date of discharge. I was told that community packages (ComPacks) is a discharge program case managed by health teams and non-health community case managers designed to assist patients to leave hospital and return to functionality in a timely manner. ComPacks patients need community support services to allow them to leave hospital and the program aims to optimise their access to those services.

3.38 There are a number of projects specifically for elderly patients which adopt similar principles, including Aged Care Services in Emergency Teams (“ASET”); Acute Care for the Elderly (“ACE”) and Geriatric Rapid Acute Care Evaluation (“GRACE”) developed by Hornsby Ku-ring-gai Health Service; Healthcare for Older Persons Earlier (“HOPE”) and the OPERA (Older Persons Evaluation, Review and Assessment) at Westmead Hospital. I discuss these later in this chapter.

3.39 NSW Health informed the Inquiry that, in Australia, a coordinated care approach has been trialled by the Commonwealth Department of Health and Ageing and the National Chronic Disease Management Strategy which identified the need for the following:⁴⁵

- systems that identify and proactively register patients at a population level and monitor their ongoing participation;
- evidence-based practice guidelines;
- self-management (supported by primary prevention, behaviour modification programs, compliance/surveillance) as the preferred model of care for almost 80 per cent of patients;
- funding and organisational structures that support multidisciplinary care, care planning and coordination and review;
- recognition of the GP as the main medical care provider;
- coordinated regional networks of health care providers; and
- information systems incorporating a central database that provide access to population-based information about risk groups at a local level and the ability to share information between providers regardless of the sector in which they function.

Care navigation

- 3.40 Individual area health services have introduced initiatives aimed at improving access to care for patients, particularly those with chronic conditions. The Inquiry received evidence about a system called “Care Navigation” devised and implemented in the Sydney West Area Health Service. Kathleen Harrison, the Network Director, Access and Patient Logistics for the area health service⁴⁶ has a key role in implementing the project and described its features to me.
- 3.41 “Care navigators” co-ordinate the provision of medical services to chronic and complex patients, who often experience difficulty accessing medical services in a timely fashion.⁴⁷
- 3.42 “Care Navigation” starts in the community, so that admissions can be managed so as to avoid the Emergency Department by:
- providing care in the community with support from outreach or community based services in concert with GPs; or
 - enabling direct access to ward admission or outpatient departments.⁴⁸
- 3.43 Under the program, 2,831 vulnerable, high risk patients with high rates of presentation to hospitals in Sydney West Area Health Service were identified by interrogating the data held by the hospital in the Emergency Department computer database, FirstNet.⁴⁹ Those patients over 70 years of age with more than 3 admissions over the previous 12 months, experiencing chronic illnesses or respiratory and cardiac disorders were identified.⁵⁰ These people were “flagged” on the computer system, with a view to managing them across every episode of care in a proactive way.⁵¹
- 3.44 Patient Flow Units were created to, amongst other roles, improve the capacity to respond when these patients first arrived in the Emergency Department.⁵² When a patient in the “Care Navigation” program attends the Emergency Department the Patient Flow Unit is automatically paged and calls the Care Navigator.⁵³ The Care Navigator can access the patient’s FirstNet electronic medical record and with that information fast track the client to the appropriate specialist service or alternative pathway of care.⁵⁴
- 3.45 The “Care Navigation” program identified that most of the patients in question did not have any management plan that extended past the ‘acute interface’ (that is, the hospital door). I was told that the program seeks to collate information about the care of each patient and provide the information back to the GP.⁵⁵ If the patient does not have a GP, I was told that the program seeks to find one for them.⁵⁶
- 3.46 Ms Harrison told me that it is intended in the future to set up a point of access in the Patient Flow Units to allow care providers, such as GPs, to contact the Patient Flow Unit in advance of the patient coming to hospital so that the patient can be transferred directly to whatever service is required, without ever necessarily needing to come into the hospital.⁵⁷
- 3.47 I was told that it is the aim of “Care Navigation” to prevent admissions to hospital wherever possible and to set up sustainable community-based care for patients who, by reason of their disease and age, have ongoing patient care requirements.⁵⁸ The intention is to intervene as quickly and as early as possible.⁵⁹
- 3.48 Ms Harrison told me that one recent success was a complex and chronically ill patient was with a 48 year old gentleman who had presented to the Emergency Department 38 times in 5 months, with 2 admissions to hospital. “Care Navigation” found that there was no ongoing plan for his care, and linked him with the correct services and support. In 10 weeks since, he had only presented to the Emergency Department twice.⁶⁰

- 3.49 I was told that Sydney West Area Health Service is endeavouring to build electronic links to community health databases and other databases from within Sydney West so that it is possible to access the most complete record of the patient's history as possible and in the most convenient and time efficient way.⁶¹ I am strongly of the view that this sort of patient information needs to be electronically available on a system-wide basis and I have discussed this in Chapter 14.
- 3.50 Sydney West Area Health Service also funds General Practice liaison officers to assist GPs in planning the care of chronic care patients.⁶² I have discussed the importance of General Practice liaison officers in Chapter 15 and recommended the expansion of their role by NSW Health.
- 3.51 The Inquiry received a number of submissions to the effect that a "care navigator" would be of great assistance to patients with chronic conditions. For example:
- (a) Mr Pilcher cares for his wife who has multiple sclerosis. He told me that he avoids taking his wife to the Emergency Department at Port Macquarie Hospital because of the waiting time and because the staff at the Emergency Department are over-stretched. He said that there have been times when they have attended the Emergency Department when his wife, who is quadriplegic and cannot converse, has had to sit next to agitated patients suffering from drug or alcohol problems in the waiting room. Mr Pilcher gave evidence that his wife would be better off if she was able to access a range of appropriate treatments at home and did not have to come to the hospital.⁶³
 - (b) Mr Gaffney made a submission to the Inquiry about the treatment of his wife, who died from ovarian cancer in June 2003. He said that initially the only way for Mrs Gaffney to present to her treating specialist oncologist was through the Emergency Department. Mr Gaffney submitted that junior doctors in the Emergency Department tended to waste time and make the wrong decisions, delaying the receipt of appropriate treatment by Mrs Gaffney. These issues were eventually solved when they were provided with an option to call the Nurse Unit Manager on the oncology ward, to arrange direct admission to that ward. However, this was only available during business hours. Mr Gaffney suggested to me that the system could be improved by allowing known patients to be admitted directly to their treating doctor's ward (24 hours a day 7 days a week), which would save money, time and alleviate crowded Emergency Departments.⁶⁴
 - (c) Ms Novak, who suffers from a rare chronic condition submitted to me that:

"I would like [NSW Health] to understand that for patients like myself there needs to be access to Acute Care Health, without the need to present in a crisis at hospital because we have been unable to get treatment to prevent the crisis in the first place."⁶⁵
- 3.52 A number of clinicians also advocated the use of dedicated "care navigators". For example:
- (a) Dr Rankin, a specialist haematologist at Lismore Base Hospital told the Inquiry that in his area of specialty, there has been a cancer plan from 2003 to improve cancer services. Under this plan, for every 100 patients who have complex medical needs, it is proposed that there be one care coordinator appointed to chaperone patients through the system and prevent acute admissions. However, I was told that the model has never been implemented due to an absence of funding.⁶⁶
 - (b) One witness told me about the care of patients with disabilities. She described a number of occasions when physically disabled patients (for example with

quadriplegia, severe communication and cognitive problems or traumatic brain injury) have entered hospital and received care that does not meet the requirements of care arising from their disability. She suggested that a member of staff should be identified as responsible for ensuring that the care of people with disabilities caters to all of their care needs, not just the immediate acute problem. She said that it is particularly important that such a designated care co-ordinator meet the patient. I agree with that submission.⁶⁷

- 3.53 I also consider that it is important that, when relevant, such "care navigators" include the patient's carer in the patient's treatment.
- 3.54 "Care Navigation" seems to me to be conceptually an excellent scheme and the way of the future for patients who have chronic or complex disease conditions. It has features which are similar but not identical with the NSW Chronic Care Program and the Severe Chronic Disease Program and various other local programs. It is not for me, to design all of the technical features of a program such as this. It is sufficient for me to say that having carefully examined each of these programs and taken some care to understand them, that conceptually they are the way of the future.
- 3.55 Such a program ought to be available on a state-wide basis within each area health service and administered locally by that area health service. It is not necessary that the programs be identical because they will each reflect the health of the patients in the area, the availability of services in the community and in the hospital. The important features are to have the patient's care needs coordinated by a single person such as a general practitioner or care coordinator (or navigator). That person needs to ensure that as many services as possible take place outside of the acute care hospital, and that admission to an acute care hospital should not unless clinically necessary happen through the emergency department, but rather be planned directly into a particular ward or, if appropriate to a Medical Assessment Unit.
- 3.56 Consideration also needs to be given by NSW Health as to how each of these programs which I have been discussing will interact with each other, and what the criteria are for admission to programs of differing kinds.

Conclusion about chronic disease programs

- 3.57 As noted above, the Inquiry received submissions from a number of patients and carers regarding the need for co-ordinated treatment.⁶⁸
- 3.58 In my view, there needs to be a better mechanism for managing such patients, to ensure that they receive the care they need, wherever they live in NSW.
- 3.59 Although there has been a recognition of the need for better coordination of care for patients suffering from chronic disease, and considerable effort has been made in that direction, all of the strategies in place at the moment are, one way or another, piecemeal. That is, they apply to specific groups of patients (eg the over 65 year olds, those with dementia) or are confined to specific geographic locations. There is currently no one project that attempts to ensure a co-ordinated, completely funded approach to this problem on a state-wide basis to include all chronic diseases. This is no doubt due to funding constraints.
- 3.60 In its recent September 2008 report, *Framework for Performance Improvement in Health*, the Independent Pricing and Regulatory Tribunal of NSW (IPART) noted that it is generally accepted that chronic diseases are best managed by systems of care that are integrated.⁶⁹ IPART also noted that integrated care is in its infancy in this country, and there is currently no plan for an effectively integrated system of health care in

Australia or NSW.⁷⁰ In IPART's view this is not due to a lack of understanding of the importance of integrated care to manage chronic diseases, or to a lack of policies and initiatives, but is due to structural obstacles – particularly the complex nature of funding arrangements and the different incentives faced by different parts of the system.⁷¹

3.61 IPART expressed the view that the primary care sector is best placed to lead the care of patients with chronic disease. It reported that in an 'ideal world' – one in which there is a strong joint Commonwealth/State approach to integrated care - it would be better to establish a Commonwealth driven, GP-led chronic care management strategy.⁷²

However, noting that this is unlikely to happen IPART supported NSW Health's proposal to introduce a State-based 'coordinated care' arrangement for people with serious chronic diseases.⁷³ However, it recommended that NSW Health continue to pursue the option of a Commonwealth-driven arrangement that strengthens the role of GPs.⁷⁴

3.62 IPART recommended:⁷⁵

"That NSW Department of Health continues to use COAG and related processes to advocate for a national, chronic care management strategy that strengthens the role of GPs in parallel with the public hospital and community health sectors. In the absence of an imminent, national coordinated chronic-care model, that NSW Department of Health pursue its proposed State-based 'coordinated care' arrangement for people with serious chronic diseases."

3.63 I agree generally with IPART's conclusions and make a recommendation as follows.

Recommendation 3: *NSW Health's Severe Chronic Disease Management Program should be implemented and expanded to include all "very high risk" and "high risk patients" over the age of 18.*

Treatment outside hospital

3.64 The "Care Navigation" project outlined above focuses on permitting patients suffering from chronic complex conditions to receive care in the home and community, rather than in hospitals.

3.65 I heard evidence of a number of other simple projects which have provided people suffering from chronic and complex conditions with medical support without the need for hospital admission.

3.66 The Australian Health Policy Institute referred the Inquiry to research indicating that a nurse-led 24 hour telephone hotline for patients with chronic obstructive pulmonary disease reduces hospital use and is safe.⁷⁶ The Australian Health Policy Institute highlighted that such mechanisms not only take pressure off the public hospitals, but assist the patient.⁷⁷

"Some of these people wake up at 2am in the morning with a panic attack and need someone to talk to. If there is no one to talk to, they call the ambulance. If they call the ambulance, they end up in ... [the] emergency department ... [which] may or may not have their medical records ... and they may or may not end up intubated."

3.67 During my visit to Dorrigo Multi-Purpose Service, I was told that an after-hours phone line staffed by nursing staff has been introduced for the Service's palliative care patients. Staff told me that it had reduced presentations to the Emergency Department "enormously".⁷⁸ Enquiries to the phone line generally concerned appropriate pain relief,

patients seeking reassurance and distressed family members regarding the patients symptoms.

- 3.68 Community health services such as HealthOne focus on alleviating the burden of chronic disease by bringing together GPs, community health workers, allied health professionals and other medical practitioners. HealthOne uses community nurses and GP liaison nurses to enhance the coordination of care for complex and chronic patients. I have discussed this further in Chapter 21.
- 3.69 These ideas have much to commend them. A more advanced model is the Hospital in the Home.

Hospital in the Home

- 3.70 The Hospital in the Home Society of NSW provided to the Inquiry with the following definition of "Hospital in the Home".⁷⁹

"Hospital in the Home (**HITH**) is a substitute for acute or post-acute care provided in the hospital; therefore if it did not exist the patient would be admitted to hospital or have to remain in hospital. HITH teams consist of a variety of health professionals providing care to patients in accordance with both a clinical assessment of the patient's needs and specific treatment protocols. HITH services provide the patient with personal and clinical support and effective coordinated management of a clinical condition for a defined period. The patients considered for inclusion in these programs are medically stable, not requiring very high clinical support but may include multi-morbid patients with complex needs. The care setting is usually the patient's place of residence including in a residential aged care facility, but some treatment could be provided in an outpatient clinic or day only treatment clinic."

Page 51

- 3.71 I was informed that the conditions treated include, but are not limited to: pneumonia and acute exacerbation of chronic obstructive pulmonary disease, urosepsis, cellulitis, osteomyelitis, septic arthritis, endocarditis, septicaemia, deep venous thrombosis, pulmonary embolism, anticoagulation for atrial fibrillation, post-orthopaedic rehabilitation and post-operative treatment for some surgical patients.⁸⁰
- 3.72 The types of treatments dispensed include, but are not limited to: intravenous antibiotics, anticoagulation, transfusions, other infusions, rehabilitation, nebulisers, home oxygen, chest physiotherapy, occupational therapy home visits, and the supply and fitting of aids.⁸¹
- 3.73 The Inquiry was given research which indicates that Hospital in the Home is very effective, and is preferred by patients. It is reported that:
- (a) Published studies have documented a number of improvements in health outcomes, including a decrease in the incidence of confusion (delirium),⁸² geriatric complications involving the urinary tract and bowel, as well as a 25% decrease in Adverse Events.⁸³ Preliminary results from a meta-analysis of 40 Hospital in the Home studies showed that Hospital in the Home treatment resulted in a 18% decrease in mortality.⁸⁴
 - (b) Preliminary results from the meta-analysis also showed that out of 11 randomised controlled studies that assessed patient satisfaction with Hospital in the Home, all patients were more satisfied with Hospital in the Home than with in-hospital treatment.⁸⁵

- (c) Two Australian costing studies have found that Hospital in the Home care is less than half the cost of inpatient care.⁸⁶ In the meta-analysis there were 19 studies that performed costing analyses, and in 17 of these the cost of Hospital in the Home was cheaper and was on average 74% of the cost of in-hospital care. In all 11 of these studies where Hospital in the Home completely substituted for inpatient care Hospital in the Home was cheaper, on average being 64% of the cost of in-hospital care.⁸⁷

3.74 I heard evidence about 2 Hospital in the Home type programs operating in NSW.

- (a) Acute Post Acute Care (**APAC**) which serves all Northern Sydney and Central Coast hospitals. Nicholas David Marlow, Area Manager of the APAC service informed me that:⁸⁸
- (i) APAC serves all Northern Sydney and Central Coast hospitals, as well as working in the community as an acute care substitute.
 - (ii) APAC is a virtual hospital accessible by referral from doctors (GPs or doctors in Emergency Departments), nurses, allied health. The APAC service undertakes care of patients and also supports carers. APAC provides acute care that would otherwise traditionally and historically be managed in the Emergency Department or in the hospital ward.
 - (iii) APAC currently substitutes between 110 and 130 acute beds daily across the Northern Sydney Central Coast Area Health Service, being about 10% of beds across that area health service. A goal has been set for 2008/2009 for APAC to substitute approximately 150 beds.
 - (iv) APAC has an agreement with the GP to use APAC's clinical guidelines, which are routinely reviewed every two years with the latest literature. There are guidelines for referral to APAC and clinical guidelines for the treatment of patients, to remove disparate practices. APAC tries to standardise practice with a single set of clinical guidelines developed with the assistance of pharmacy, occupational therapists and physiotherapists, among others.
- (b) At Prince of Wales Hospital, the Post Acute Care Services includes the Hospital in the Home initiative. It is lead by Dr Gideon Caplan, Director of the Department of Geriatric Medicine & Post Acute Care Services. Dr Caplan described the following features of Hospital in the Home to me:⁸⁹
- (i) Patients can be referred to Hospital in the Home by their GP, the Emergency staff or staff in any ward in the hospital.
 - (ii) Patients are treated wherever they live, including some care to homeless people.
 - (iii) Treatments range from intravenous antibiotics, blood transfusions, injections and infusions, and rehabilitation. Patients considered for inclusion in Hospital in the Home are medically stable, not requiring very high clinical support but may include multi-morbid patients with complex needs.

3.75 There are a number of impediments to Hospital in the Home.

- Funding problems, as Hospital in the Home is caught between Commonwealth and State Government funding.⁹⁰ Hospital in the Home blurs the boundaries between the hospital and the community, and there is a real lack of clarity as to whether the cost is to be borne by the State or the Commonwealth.⁹¹ The Hospital in the Home Society of NSW submitted that there are no suitable funding model or Medicare Benefit Schedule item numbers that cater for this model, which leads to inertia.⁹² It was suggested, for example, that item numbers should apply to the time health staff spend driving around to see the patient. There are no uniform incentives across the state or the country that would allow these systems to work better. Medicare Benefits Schedule items to allow GPs and doctors to participate would be of great assistance.⁹³
- Poor Information Technology systems in NSW public hospitals. The poorly financed and very poorly structured IT systems are an impediment to the effective implementation of Hospital in the Home initiatives.⁹⁴
- Difficulties recruiting doctors due to the funding issues referred to above. I was told that it has been hard to attract new doctors to Hospital in the Home because there are no financial incentives and a lot of disincentives. It is much harder to see a group of patients in the community than on a ward round.⁹⁵
- Lack of a state-wide approach. Professor Caplan submitted that there is no system-wide planning by NSW Health in relation to the Hospital in the Home program. Initiatives start at individual hospitals and area health services.⁹⁶ Professor Caplan told me that NSW Health has not invested money directly in these programs, although it has encouraged the Area Health Services and hospitals to take on these functions. He said that it would be of benefit if NSW Health took a more interventionist role in coordinating and investing in the service, in research and driving things forward.⁹⁷ Professor Caplan submitted to the Inquiry that a central model would allow more uniformity and transportability of the model so that it reaches more parts of the health system.⁹⁸ He told me that, at the moment, there are huge gaps in the system across the state. There are huge differences in terminology and it is difficult to educate the doctors and nurses of the future about how the system works.⁹⁹

3.76 It seems to me that Hospital in the Home is the way of the future and deserves the articulated support of NSW Health and an appropriate funding model. As Dr Caplan submitted to me:

"there is a huge potential in the interaction between chronic disease management and hospital in the home to overlap these services. We would like to see more of a union so that, for example, there are systems of chronic disease nurses who go out and visit people. If they had links with hospital in the home, say, for example, people with cardiac failure, to be able to go out and give them intravenous injections of diuretics of medicine to help their heart failure. A lot of times you could prevent a hospitalisation by doing that."¹⁰⁰

3.77 The NSW Auditor-General has recently delivered a report on whether 4 of NSW Health's out-of-hospital programs provide effective alternatives to treatment in hospital.¹⁰¹ The 4 programs reported on by the Auditor-General were:¹⁰²

- Community Acute/Post Acute Care (**CAPAC**);
- ComPacks;
- Rehabilitation for Chronic Disease; and
- Healthy at Home.

- 3.78 The Auditor-General found that in NSW, nearly 45,000 patients per annum are currently being treated out of hospital in NSW Health's CAPAC, ComPacks and Rehabilitation for Chronic Disease programs.¹⁰³ It was estimated that these out of hospital programs operate at around half the cost of providing the care in hospital, costing \$55 million less per annum. The number of patients cared for is equivalent to 3% of inpatient admissions and 2% of beds.¹⁰⁴
- 3.79 In relation to the Healthy at Home pilot, it was recommended that this be continued until it is demonstrated that the program is meeting its objectives.¹⁰⁵
- 3.80 One of the Auditor-General's key recommendations was that NSW Health should establish an interim team to plan the expansion of out of hospital programs, coordinate it with existing Area Health Service responsibilities, and monitor progress of implementation.¹⁰⁶
- 3.81 The Auditor-General noted that there were limitations on the available data regarding the effectiveness of the available programs and made corresponding recommendations for NSW Health to improve monitoring and data collection.¹⁰⁷ I note that the issue of inadequate availability of data in many different contexts has been brought to my attention and I have further discussed this issue and made recommendations elsewhere in my report.
- 3.82 In my view, NSW Health should consider and develop a comprehensive plan for the expansion of Hospital in the Home programs of care for chronic and complex patients a feature of which would include the identification of patients in the community who otherwise may need to be admitted to acute care hospitals.

Recommendation 4: *NSW Health should consider and develop a comprehensive plan for the expansion of Hospital in the Home programs of care for chronic and complex patients. The program should be implemented throughout NSW hospitals within 18 months.*

Elderly patients

- 3.83 As described in Chapter 2, our population is ageing, and increasing pressure is being brought to be bear on the public hospital system as baby boomers start to experience health difficulties in their later years.
- 3.84 The Inquiry was informed that:
- Half of all hospital beds are occupied by patients aged over 65.¹⁰⁸
 - Hospital presentations by the over 75 age group are growing at the rate of 20% per annum.
 - Whilst the average length of stay in hospital is 4 days, this increases to 9 days for people over 75.
 - People aged 65 years and over consume 42.9% of total acute bed days in public and private hospitals.¹⁰⁹
 - By 2026, over 20% of the NSW population will be aged 65 and over, representing an 87.3% increase in this population segment between 2001 and 2026.¹¹⁰
 - By 2011, persons aged over 65 will account for 38% of NSW public hospital admissions and 52% of bed days.¹¹¹

- By about 2021 there will be 1.3 million Australians over the age of 85. The incidence of neurodegenerative diseases rises most rapidly after 80 years of age.¹¹² This will increase demand, including, for the treatment of falls in the elderly due to gait problems caused by neurodegenerative disease and demand for dementia-specific services. It was submitted that of those 1.3 million Australians over the age of 85:
 - (i) 85% will require assistance with domestic care;
 - (ii) 30% will require assistance with personal care;
 - (iii) 70% will be cognitively impaired (e.g. delirium); and
 - (iv) 70% will be mobility impaired and at high risk of falls.¹¹³
- 3.85 A geriatrician submitted to the Inquiry that it is expected that there will be a 50% increase over 5 years in the number of persons aged over 85 presenting to Emergency Departments.¹¹⁴
- 3.86 The Inquiry received submissions that the elderly are often seen as an unwelcome patient group in hospitals and that this is reflected in a range of derogatory terms used to describe them including “gomers” (“get out of my emergency room”), “turfs”, “sloughs”, “crumbles”¹¹⁵ and “bed blockers”.¹¹⁶
- 3.87 Those who work in aged care have also experienced this prejudice. One geriatrician told the Inquiry confidentially that he and his colleagues feel they are treated with disdain and contempt by the health sector¹¹⁷. They are seen as the cause of the problem rather than the solution, and often they feel blamed for the numbers of elderly patients having the temerity to present to hospital and consume “acute care beds.”¹¹⁸ I am told that referrals from other disciplines to geriatricians are frequently based on the premise of transferring a problem rather than devising a solution. Assistance provided is seen as a sign of personality weakness and transfer of care a victory on the part of the referrer and the recipient “worthy of scorn.”¹¹⁹
- 3.88 I was told by a manager of aged and extended care in Wagga Wagga that one cause of the problem described by geriatricians is ageism within acute care facilities. I was told that this is perpetuated because acute care staff are not educated about the illnesses and conditions which commonly afflict elderly patients - dementia, behavioural problems, delirium, anxiety and depression.¹²⁰
- 3.89 The essential features of medical illness in elderly are co-morbidity, complexity, lack of physiological and functional reserve and a propensity for illness to be manifest in characteristic ways: immobility, incontinence, instability and impaired intellect/memory.¹²¹ Single disease or trauma related admissions are often complicated by the co-morbidities of dementia and/or delirium.¹²²
- 3.90 It is apparent that elderly patients, as a group, do not fare well in a hospital environment.

- Lying in a hospital bed is sedentary, and patients lose muscle tone rapidly.¹²³ Prolonged bed rest is a major risk factor for losing muscle strength,¹²⁴ and exposes patients to problems such as pneumonia, urinary tract infection, and complications such as osteoporosis.¹²⁵ It is estimated that each day spent in bed results in a 5% decrease in muscle mass. This means that 10 days of bed rest requires 4 months to restore the body mass to original levels.¹²⁶ I was told that nursing patients out of bed, and in chairs, wherever possible is a successful model of care,¹²⁷ as is increasing the intensity of therapy, which has been shown to improve clinical outcome and shorten length of stay.¹²⁸ It was submitted to me by the NSW Branch of the Australasian Faculty of Rehabilitation Medicine (Royal Australasian College of Physicians) that in the United States, 2 to 3 hours of therapy per day is mandated in inpatient rehabilitation units, but that this is far from what occurs in NSW public hospitals.
- Loss of muscle tone causes elderly patients to be more prone to falls getting out of bed, and whilst toileting.¹²⁹
- There are no organised social activities in hospital, as there might be in their home, community or nursing home.
- Food is insufficient for long stays. Elderly patients frequently will also have difficulties opening the packaging or reaching their food, and therefore do not eat and become malnourished.¹³⁰ According to a submission by Associate Professor Peter Lipski, up to 60% of hospitalised Australians over 65 yrs are malnourished.¹³¹ The Inquiry was informed that over 50% of acute geriatric medical patients have some form of significant malnutrition, which has been linked to increased mortality and morbidity, a longer and more complicated stay, and significantly increased treatment costs.¹³² A study of 102 elderly patients admitted to Prince of Wales Hospital in 2007 found that almost 80% were malnourished or at risk of malnutrition based on their weight, food intake and overall health.¹³³
- Hospitalised elderly patients have higher rates of adverse events such as medical errors and infections, which leads to loss of functionality and extended lengths of stay.¹³⁴ Elderly patients who have fragile skin are more likely to develop pressure sores from lying in hospital beds for extended periods, which also increases the risk of an infection.

- 3.91 A number of submissions made to my Inquiry by elderly patients referred to their fear of acquiring an infection whilst in hospital. A female patient admitted to Coffs Harbour Hospital for a hernia operation described sharing a bathroom with patients who had significant infections and incontinence.¹³⁵ The carer of an 84 year old female patient at Hornsby said that her mother was placed in a ward with a shared bathroom which could not be used for several days because it was “infectious”.¹³⁶ I was told that this caused considerable difficulty for patients with reduced mobility. I was told that an elderly patient at Concord Hospital contracted MRSA after a cannula was left in his arm for an extended period.¹³⁷
- 3.92 It seems clear to me to be preferable for elderly patients to be treated away from hospital when appropriate. The risks posed to the elderly of immobility and infection in hospitals point to the home environment as the better place to receive as much of the health care as is possible.
- 3.93 I was told that Emergency Departments do not cope well with large numbers of elderly patients, as they are often suffering from a number of medical problems. Access block can increase due to difficulties finding a consultant who will accept the care of patients with multiple problems, before all relevant tests are performed.¹³⁸ I was told that at Sutherland Hospital, an increasing number of “super elderly” presentations (patients over 90 years) is contributing to access block.¹³⁹ One-third of Emergency Department

patients at Sutherland are over 80 years, and, on average, 10 “super elderly” patients are admitted to the Emergency Department each night.¹⁴⁰ (I noted during my visit to Sutherland Hospital that it has a large geriatric ward and impressive aged care and geriatric programs).¹⁴¹ Associate Professor Peter Lipski gave evidence to this effect:

“Older people cannot access clinics. You need to see them at home, to identify their falls risk and how they are managing in their home environment, particularly with people with frailty and dementia they just can’t travel...The most important thing for the acute system is you can bypass the dreaded acute public hospital ED admission.”¹⁴²

Unnecessary delays in discharge

- 3.94 One issue that was frequently mentioned to me by staff during my visits to Emergency Departments was that elderly patients often occupy acute care beds while they await appropriate accommodation elsewhere. This is due to a number of factors.
- 3.95 The process of discharge of elderly patients can be complex depending on their needs. For example, in some cases, the Guardianship Tribunal may be involved in cases where the patient has a decision-making disability or is unable to give informed consent for medical treatment (for example, if the patient has dementia, a mental illness, intellectual disability or brain injury). This can delay discharge. In some cases, a patient may need to be assessed by an Aged Care Assessment Team (**ACAT**) to determine his or her needs following discharge and to assist the patient to find either a local community service to assist with care at home or a suitable residential aged care facility. A placement may need to be booked with a nursing home or aged care facility. In the meantime, the patient will remain in an acute care bed in a public hospital. Obviously, every delay along the way reduces bed availability for other patients.

Lack of aged care beds

- 3.96 A recurring theme at hearings and hospital visits throughout the State was the lack of aged care beds.
- 3.97 The Commonwealth Government funds aged care facilities to provide residential aged care to older Australians whose care needs are such that they can no longer remain in their own homes.
- 3.98 In New South Wales, there is a total of 58,008 residential aged care places. 39,880 places are in major cities, 13,930 in inner regional areas, 4,032 in outer regional areas, 210 in remote and 36 in very remote areas.¹⁴³ These figures do not include beds counted in programs designed to allow people to stay in their own homes.¹⁴⁴ These geographic categories are based on a classification developed by the Australian Bureau of Statistics. The term “regional” generally includes the centres which I have described as being rural in this report (for instance, under the ABS classification, the term “major city” includes Lismore, “inner regional” includes Goulburn, “outer regional” includes Braidwood, “remote” includes Nyngan and “very remote” includes Bourke).¹⁴⁵
- 3.99 The evidence received by the Inquiry included the following:
- At Westmead Hospital, I was told that high-acuity nursing home provision in the areas surrounding the hospital was adequate, however in rural and remote areas it was very limited.¹⁴⁶

- On my visits to Broken Hill, Coffs Harbour, Oberon, Macksville, Walgett, Rylstone, Wagga Wagga and Gosford I witnessed the shortage of aged care beds, and the flow on effect this has by increasing access block.¹⁴⁷
- I was told that there is a shortage of aged care beds in Broken Hill, particularly for low acuity patients. It was submitted that the hospital's surgical ward has an 80% occupancy rate largely as a result of the lack of nursing home placements which impedes the discharge of recovered patients. It is not unusual for patients to wait in acute medical wards for nursing home placements.¹⁴⁸ Dr Flecknoe-Brown described the situation in Broken Hill as follows:¹⁴⁹

"... we would have anywhere between 15 and 25 people [at any one time] occupying acute care beds who would be far more appropriately cared for in an aged care facility. That is in addition to the 10 to 15 people who are struggling along at home who would be much better cared for in a properly built and operated aged care facility."

- I was told that Oberon Multi-Purpose Service is reluctant to assign patients to aged care beds outside its area, and so many end up occupying acute beds for lengthy periods.¹⁵⁰ The Oberon Multi-Purpose Service, which was built in the late 1990s, currently has 8 high level aged care beds. Demand for them is constant because the nearest like facilities are in Bathurst and Lithgow. This reduces the chance of their families visiting.¹⁵¹
- I was told that Macksville Hospital has a waiting list of 16 patients for residential aged care places, 8 of whom have been waiting for more than 6 months.¹⁵² I was told that the town is short by about 20 aged care beds.
- In Walgett, aged care facilities are also scarce, and there is a shortage of low care nursing beds.¹⁵³
- Rylstone also suffers a shortage, often causing patients requiring low-level care to be admitted to the hospital for periods of respite. Obviously care such as this could more cost effectively and appropriately be provided in a hostel or some other suitable accommodation.¹⁵⁴

3.100 An insufficient number of aged care places can worsen access block and cause longer waiting times for surgery. I was informed that the Orthopaedic Ward at Gosford Public Hospital, for instance, "probably runs at 120% occupancy". I was told that patients cannot be discharged because it is difficult to find rehabilitation or residential aged care places:

"We also have the problem of getting people moving through the beds, so getting a patient out of a bed to create the availability is also a major problem for us. We don't have enough geriatric services and rehabilitation services, and we certainly have a blockage when it comes to moving them into a rehab bed or a nursing home bed."¹⁵⁵

3.101 In Wagga Wagga, I was told of the pressure on acute care services to care for patients who do not have adequate support to maintain functionality in their own homes, but for whom there are no available residential care facilities.¹⁵⁶ When there are no local beds available, there is further pressure to "decant" people out to peripheral areas or nursing homes in other areas. This is a significant difficulty for carers who need to travel long distances to those outlying areas.

3.102 Although the provision of aged care beds is an issue for the Commonwealth government, the evidence received by the Inquiry clearly indicates that a lack of aged care beds adversely impacts in a very significant way on bed availability in acute care hospitals.

Special needs

- 3.103 The Inquiry was informed that elderly patients with special needs are particularly difficult to place, as nursing homes by and large do not accept such patients. As a result, these patients often wait for extended periods in an acute hospital bed. Witnesses submitted that special needs patients commonly have one or a number of the following characteristics:¹⁵⁷
- (a) They require secure, dementia-specific care;
 - (b) They are behaviourally challenging for staff;
 - (c) They are too young to qualify for aged care;
 - (d) They require dialysis;
 - (e) They have infections such as Vancomycin-resistant Enterococci (VRE) or Methicillin-resistant Staphylococcus Aureus (MRSA);¹⁵⁸
 - (f) They cannot afford a hostel bond and must wait for what is called a concessional hostel bed; or
 - (g) They are simply uncooperative as they would like accommodation that is unavailable or inappropriate.
- 3.104 This is a very real problem. I was told at Nepean Hospital that on the day of hearing, that one patient in the hospital had been awaiting aged care placement for 15 days, another for 26 days and another 23 days, for some of the above reasons. Alarming, I was also told that one patient had been occupying a bed in the hospital for 96 days awaiting a nursing home bed.¹⁵⁹ I was told that 70% of special needs elderly inpatients can be placed in about 5 or 6 days but that around 30% are “not really catered for by the Commonwealth”, such as those I have just mentioned, and they then become “bed-blockers”.¹⁶⁰
- 3.105 NSW Health informed the Inquiry that the average daily cost of providing inpatient care to a patient awaiting placement in a nursing home is approximately \$616. On that basis, a patient awaiting a nursing home placement for 96 days, such as the patient I was told about at Nepean Hospital, costs the State just under \$61,000.¹⁶¹
- 3.106 Part of the solution is to provide transitional placements for those awaiting care.¹⁶² Transitional Aged Care is a program to address the needs of older people who, in the absence of the program, would require residential aged care. It is a 12 week period of support and low intensity therapy in a residential or community setting which provides older people who have been assessed by an Aged Care Assessment Team as eligible for admission to residential aged care with an opportunity to improve their functional capacity so that their long-term care requirements can be properly determined.
- 3.107 As noted above, the Commonwealth Government is responsible for funding aged care facilities. The Minister for Ageing, The Hon Justine Elliot MP, announced a \$158 million plan at a COAG meeting in March 2008 to move 2,000 older Australians occupying hospital beds into aged care.¹⁶³ More recently, the Commonwealth Government has increased funds to the plan so that it is now worth \$293.2 million.¹⁶⁴ The plan now includes 69 fully-funded transition care places for NSW for 2008-09, 54 of which are currently operational.¹⁶⁵ The Commonwealth Government announced that once the plan is fully operational it will help up to 518 people a year. Transition care places are currently located in Coffs Harbour, the Lower Hunter region, Greater Newcastle, Inner-city Sydney and Western Sydney.

- 3.108 I was told that one of the difficulties is that the protocols used to determine admissions to nursing homes are determined at the federal level, and are different from the protocols used in acute care hospitals to determine discharge. This creates a situation where it is possible that a nursing home will decide not to take a patient who is ready for discharge.¹⁶⁶

Guardianship Tribunal

- 3.109 The Inquiry received evidence about the length of time elderly patients wait in acute hospitals for an assessment by the Guardianship Tribunal.
- 3.110 I was told that the Guardianship Tribunal views a hospital as a safe environment and on that basis does not treat applications concerning hospitalised patients on an urgent basis.¹⁶⁷ I was told that a patient may wait between 2 weeks and 3 months for their hearing, and then another 6 weeks before a decision is made by the Guardianship Tribunal, as to whether a guardian should be appointed.¹⁶⁸
- 3.111 The Tribunal informed the Inquiry that applications are investigated by its Co-ordination and Investigation Unit before they are listed for hearing.¹⁶⁹ Applications are prioritised according to the urgency of the matter, the complexity of the issues involved and the needs and interests of the person with a disability. An application may be classified as urgent for a number reasons, including whether the person's welfare, wellbeing and best interests are at risk.¹⁷⁰
- 3.112 Some say that the solution is for NSW Health to enter a memorandum of understanding with the Guardianship Tribunal to prioritise hearings for patients residing in acute facilities.¹⁷¹ I was told that the impact on access to acute care beds is significant even if the numbers of patients requiring guardianship is not large.
- 3.113 Diane Robinson, President of the Guardianship Tribunal, has told the Inquiry that the Tribunal does not have a policy relating to patients in hospital care.¹⁷² According to the Tribunal's case management system, a person the subject of an application, who is in hospital, *may* be given priority for hearing if:
- without immediate intervention, alternative accommodation will be lost; or
 - on the basis of their health, or the impact of ongoing hospitalisation on their health, they should be given priority.
- 3.114 The Tribunal has informed the Inquiry that it is currently reviewing its case management processes in general in response to its increasing workload, occasioned in large part by the ageing of the population.¹⁷³
- 3.115 I listed above (see paragraph 3.90) the potential adverse consequences of hospital stays for the health of elderly patients. This evidence should be made available to the Guardianship Tribunal together with a clear statement from NSW Health of why the home is the preferred setting for the care of older patients.
- 3.116 There needs to be a whole of government approach, and cooperation between the Commonwealth and State governments, to keep elderly people out of hospital and, to expedite their discharge from hospital into alternative residential care as quickly as is possible.

Recommendation 5: *NSW Health should liaise with the Guardianship Tribunal to ensure that patients within acute care services in NSW public hospitals who are medically fit for discharge be given the appropriate priority for a hearing by the Tribunal.*

ACAT assessments

- 3.117 Aged Care Assessment Teams (**ACATs**) are multidisciplinary clinical teams that assess the needs of frail older people and assist them with advice and referral to appropriate aged care and community services.¹⁷⁴ ACATs are funded by the Commonwealth Government, with contributions by the State Government.
- 3.118 Since the 1980s, 44 ACATs have operated in NSW. The Commonwealth sets the national policy direction for the program, and NSW Health oversees the operation of ACATs, with day-to-day management vested in the respective area health services. ACAT assessments must follow set guidelines and procedures, including an evaluation of a patient's restorative potential and physical health, mental health, social (including carer's needs) and economic status and functional status, amongst other things. The assessment normally continues until a care plan is developed and an effective referral has been made to either a local community service to assist with care at home, or a suitable residential aged care facility.¹⁷⁵
- 3.119 Complaints were made to the Inquiry about the length of time patients wait for an ACAT assessment, in acute care beds in hospital.
- At Bankstown Hospital, I was told it can take up to one week for all required parties to sign-off on an assessment after the initial completion.¹⁷⁶
 - At Ballina Hospital, the Inquiry was informed that it takes weeks to get an ACAT assessment and weeks to get transitional care. This means patients are in the hospital for longer and deteriorate during this time.¹⁷⁷
 - At Mudgee Hospital, ACAT assessments can be delayed by up to one month.¹⁷⁸
 - I was told by a social worker that ACAT is often unable to proceed with their assessment and approvals for cases requiring placement with an Aged Care Facility or community care package until the capacity of the patient is determined by the Guardianship Tribunal and legal proxies are appointed.¹⁷⁹
- 3.120 According to a 2003/04 performance audit by the NSW Auditor General, ACATs in NSW take a slightly longer time to commence assessments than the national average, but do so more quickly than 3 other states.¹⁸⁰

Recommendation 6: *Aged Care Assessment Team assessments of inpatients should be planned to commence as early in a patient's stay in hospital as is possible so that they are completed at the time the patient is medically ready for discharge.*

Treating elderly patients more smartly

- 3.121 While there will always be times when older patients require care in an acute hospital environment, two things need to happen:
- (a) better models of care need to be implemented to ensure older patients can be admitted to the most appropriate part of the hospital directly, and discharged home (with the support of community health if needed) or nursing home as soon as possible; and
 - (b) treatment out of hospital should be pursued wherever possible. This is because, in the absence of an ongoing acute care episode, the medical evidence supports the view that it is detrimental for elderly people to remain in hospital settings.
- 3.122 I was referred to the work carried out by Professor Gideon Caplan and others that indicates that by working with nursing homes and general practitioners, it is possible to

identify a subgroup of people for whom admission to hospital is not appropriate in the event of deterioration.¹⁸¹ I was told that advanced care planning in the form of written advanced care directives for nursing home patients is important in this regard. Advanced care directives express preferences for future medical treatment.¹⁸² They allow patients to make decisions about whether they wish to be admitted to hospital to receive treatment, which may not always be in their best interests.¹⁸³

3.123 I have seen a number of good models of care in use as hospitals around the State.

- Aged Care Services in Emergency Teams (**ASET**) were established in 2002.¹⁸⁴ They aim to improve the care and management of older people presenting to the Emergency Department by providing appropriate access to services on admission. On 18 August 2002, the then Minister for Health announced that ASETs were to be established in 34 metropolitan and rural hospitals across the State at a cost of \$5.5 million.¹⁸⁵ By September 2007 all 9 principal referral hospitals had ASET services in place.¹⁸⁶ I am told by NSW Health that a further 4 hospitals are expected to have ASETs established during 2008/09.¹⁸⁷ ASET teams provide “early multi-disciplinary assessment of complex older people”, which, according to Professor Peter Lipski, enables speedy discharge to a patient’s home with

“a complex care package to support them in the community without the need for multiple single organ specialty referrals, and somebody has to take the lead and manage the whole case.”¹⁸⁸

- The Geriatric Rapid Acute Care Evaluation (**GRACE**) model was developed by the Hornsby Ku-ring-gai Health Service (**HKHS**) and began operating in August 2005. Central to the GRACE model is a dedicated Clinical Nurse Consultant who liaises with GPs and aged care facilities to coordinate a single point of entry to the Emergency Department. This is done via a telephone triage service to determine such matters as the time for a patient’s admission or to coordinate discharge. Elderly patients are provided with rapid assessment so that hospital admission can be avoided or fast-tracked as appropriate.

Under the GRACE model, hospital staff provide outreach support, education and training to aged care facility staff, and facilitate rapid treatment when hospital admission is required, case managed by the GRACE Clinical Nurse Consultant.¹⁸⁹ At HKHS there are 4 dedicated GRACE beds in the Emergency Medical Unit to allow for short stay admissions pending transition to another unit. The GRACE Clinical Nurse Consultant also has a role in increasing the profile and use of advance care planning within aged care facilities, and to support GPs with linkages to outreach palliative care services to reduce the number of aged care facility residents transferring to hospital for end-of-life care.

It is HKHS’ aim that 10% of GRACE patients will have Advance Care Directives by the end of one year.¹⁹⁰ Between August 2005 and January 2006, the number of GRACE patients who were able to avoid going to the Emergency Department rose from 2 per month to 10 per month.¹⁹¹

Dr Susan Kurrle, a geriatrician at Hornsby Hospital, told me that the GRACE program has greatly reduced access block.¹⁹² Geriatric services cannot, unlike some other specialist clinical services, be concentrated into centres of ‘critical mass’. The need for these services, given the spread of our ageing population, is distributed across the whole State.¹⁹³

Rapid assessment models which reduce hospital presentations and admissions thereby reduce access block. This results, in turn, in less elective procedures being cancelled due to reduced bed occupancy rates, and reduced pressure on staff by having a single point of communication for facilities and GPs.¹⁹⁴ Critical to the success of the GRACE model was the Project Officer/Steering Committee/Clinical Nurse Consultant team, which fostered good communication between GPs, hospital and aged care facility staff through the use of information sheets, newsletters and presentations, and patient surveys with rapid feedback. The Inquiry was informed that celebrating and communicating achievements with get-togethers and awards were also important factors.

- Acute Care for the Elderly (**ACE**) is a model of care based on practices also developed by the HKHS. It is a “shared care” model between physicians, geriatricians and their teams in which multi-disciplinary teams manage the physical, chronic, psychological and other special conditions of the patient. This includes medical care review, pharmacological review and early discharge planning. The ACE model places the emphasis in care on maintaining a patient’s level of independent functioning, muscle strengthening and independence while in hospital to help them return home quickly rather than focussing solely on medical recovery. According to NSW Health, initial ACE evaluation results have shown a reduction in length of stay by 3 hours and reduced 28 day readmissions of Diagnostic Related Groups (DRGs) for Congestive Cardiac Failure and Chronic Obstructive Airway Disease (from 12.4% in the control group to 3% in ACE patients).¹⁹⁵
- Older Person’s Evaluation Review and Assessment (**OPERA**) was developed at Westmead Hospital. Senior clinicians who have expertise in the care of older people provide rapid review in the Emergency Department to identify underlying chronic diseases in addition to the acute presenting condition. On completion of the multidisciplinary assessment in the OPERA unit, patients are either discharged home, transferred to an acute medical ward or transferred to rehabilitation care, either in hospital, at home or in transitional care.¹⁹⁶ I am told that over the last 4 years, admissions to the OPERA unit at Westmead have risen by 45%, however bed usage has risen by only 10%, and there has been a 28% reduction in length of stay (from 7.9 to 5.7 days).¹⁹⁷ One geriatrician told the Inquiry that there is some evidence that OPERA units can improve case management, note keeping and communication between multi-disciplinary groups caring for older patients.¹⁹⁸
- The Healthcare for Older Persons Earlier (**HOPE**) model of care was also developed at Westmead Hospital. It aims to deliver better patient journeys for the elderly and those with chronic disease. It aims to make it easier for patients to access community services, help them avoid hospitalisation, provide faster treatment in hospital, and coordinate hospital treatment to facilitate early discharge.¹⁹⁹
- To achieve this, the HOPE Program brings together the following four components:
 - (i) Medical Assessment Units, which I discuss in Chapter 20.
 - (ii) Home care packages such as the Community Acute/Post Acute Care (CAPAC) Services and ComPacks, (case-managed packages of care for patients who need two or more community services for up to six weeks on discharge from hospital).
 - (iii) A ‘Single Point of Access’ program at the area health service level through which a GP or patient can arrange community care, including podiatry, home nursing, X-ray, diabetic educators and physiotherapy, etc through one phone call.

(iv) Rehabilitation services for people with chronic disease, providing long-term case management in the community, reducing hospitalisation and improving quality of life.²⁰⁰

- On my visit to Sutherland Hospital I was told about a program of shared care between geriatricians and orthopaedic surgeons.²⁰¹ If an orthopaedic patient at the hospital is over 70, a member of the geriatric team automatically becomes involved in their care. Benefits of the model were that the overall care of the patient could be started earlier, and their transition out of the orthopaedic ward to the geriatric or rehabilitation ward would be better managed.
- Another effective model is simply to send registered nurses, GPs or emergency physicians to nursing homes to treat elderly patients there rather than bringing patients into the Emergency Department.²⁰² I have been told by clinicians that the need for this kind of service is greater than ever, as the number of presentations to Emergency Departments from residential aged care facilities increases. The Inquiry received several submissions to the effect that nursing homes rely on the Emergency Department for basic medical treatment, including the treatment of urinary tract infections, catheter changes, and administration of IV antibiotics.²⁰³ It is thought that this is because nursing homes are staffed by enrolled nurses rather than registered nurses and that residents have limited access to GPs.²⁰⁴

- 3.124 Some of the common features of these models which account for their success are as follows:
- (a) having a dedicated Clinical Nurse Consultant in or near the Emergency Department who liaises with nursing homes and primary carers;
 - (b) convenient access to dedicated advice and support, 7 days per week;
 - (c) having a single point of communication, a liaison Clinical Nurse Consultant, for aged care facilities and GPs;
 - (d) having a “decision support system” through the collaboration of GPs and aged care facilities;²⁰⁵
 - (e) coordinated management plans; and
 - (f) interdisciplinary team work.
- 3.125 The successful models are based on the key principle that elderly people are medically well before they are physically able. In particular, the ACE model combines 4 key principles:
- (a) admission under dual speciality, so that there is shared care between the physicians, geriatricians and their multidisciplinary teams;
 - (b) comprehensive holistic geriatric assessment beyond the presenting illness;
 - (c) focusing on promoting independence and function; and
 - (d) early discharge planning.²⁰⁶
- 3.126 In my view, programs such as the GRACE program ought be emulated and ought to become much more widely available.
- 3.127 I have made recommendations about Hospital in the Home above.
- 3.128 As discussed in Chapter 20, I also consider that Medical Assessment Units are an important part of the solution.

Recommendation 7: *The Clinical Innovation and Enhancement Agency should as a matter of priority develop a model of care (a) that allows identification of those elderly patients for whom a hospital stay in the event of deterioration would be likely to result in adverse health outcomes; and (b) which outlines the appropriate treatment modalities for such patients out of hospital.*

Pressing workforce issues

- 3.129 There is a worrying shortage of geriatricians in NSW. Geriatricians are consultant physicians who have completed additional training in geriatric medicine conducted by the Royal Australasian College of Physicians or have achieved an equivalent standard of training.²⁰⁷
- 3.130 In 2006 there were 130 specialists who indicated geriatrics was either their main or secondary area of practice in NSW.²⁰⁸ This represents only slightly more than 2% of the total number of specialists (6170) in NSW.²⁰⁹ This highlights the very small proportion of specialists who work solely or significantly in the field of geriatric medicine. At Westmead Hospital, for example, there are 3 FTE vacancies in the department of geriatric medicine, and I am told it has struggled to attract any applicants at all.²¹⁰
- 3.131 I was told that the lack of geriatricians was due to the following:
- Poor remuneration compared to proceduralists including the bias in Medicare towards procedural items. I was told that this creates a significant financial disincentive for junior medical officers to train in geriatric medicine.²¹¹ Professor Richard Lindley who has worked in the National Health Service in the UK submitted that the fee structure in Australia involved a bizarre series of financial incentives to make some specialities far more attractive financially than others. In the UK, NHS consultants are paid the same no matter what their speciality:

“... it is no surprise the top two physician specialities in Australia are the top two interventions that pay very well. So if you are wanting to have a harbour side property, you choose cardiology and gastroenterology. This is a serious problem of financial remuneration for people who are committed to the public hospital sector.”²¹²
 - Submissions were made to the Inquiry that the Colleges are not responding to the need for generalists. The following evidence was indicative of the concerns raised by many about subspecialisation:

“The Royal Australasian College of Physicians and Governments [are] not controlling the numbers of sub-specialists trained based on the needs of the community. While the Central Coast Health Service has seen increasing numbers of complex frail geriatric patients, it is still recruiting single organ sub-specialist Doctors who do not participate in holistic multidisciplinary care of the elderly. This results in multiple sub-specialist inpatient medical consults for the same Geriatric patient which does not work to resolve the patient’s problems and does not produce a better health outcome. It is also very costly...”²¹³
 - A perceived heavy and demanding workload facing a limited number of geriatricians.²¹⁴

- The rise in sub-specialisation. Geriatric patients are clinically demanding and their medical conditions usually cover a range of medical sub-specialities. One doctor described geriatric patients who have had a recent fall with or without fractures and multiple medical illnesses as “orphans” of the system due to increasing sub-specialisation.²¹⁵ I was told that elderly patients who have sustained a fractured neck of femur can also fall through the divide between specialties.²¹⁶ I was told that because they are admitted under orthopaedic surgeons rather than physicians, their medical issues are in practice left to be identified, managed and co-ordinated by the intern on the orthopaedic team. As a result, it was submitted, these older patients do not receive the best medical care.²¹⁷ It was submitted to the Inquiry that patients who sustain a fractured neck of femur should instead be jointly admitted under physicians and orthopaedic surgeons with equal responsibility for care held by both teams. I was told that the care of complex ortho-geriatric patients “is now core business for the Orthopaedic ward.”²¹⁸
- Lack of prestige. I was told by one geriatrician that staff working with aged people “recognise their perceived worth and consequently morale is often low”. He was of the view that areas in hospitals allocated to aged care are often those vacated by the movement of more glamorous disciplines to newer areas, or located in facilities “for which no clinical justification exists but political imperatives prohibit closure.”²¹⁹

- 3.132 The Greater Metropolitan Clinical Taskforce (“GMCT”) is currently working on a collaborative ortho-geriatric model of care through its Aged Care Network.²²⁰ The evidence shows that multidisciplinary models of care treat elderly patients better.²²¹ For example, at Gosford Hospital, staff have set up a formal clinical management meeting with all local Orthopaedic Surgeons, Anaesthetists, Emergency Physicians and Geriatricians to discuss improvements to care for ortho-geriatric patients. As a result of the meetings, 3 new care initiatives to treat ortho-geriatric patients better have already been devised.²²²
- 3.133 There is a pressing need to re-evaluate the rewards for those primarily working with elderly patients. The Aged Care Network of the Greater Metropolitan Clinical Taskforce has already identified this need and has suggested to NSW Health that it consider allowing area health services to enter into special remuneration arrangements with Acute Care Geriatricians/Physicians.²²³ In my view, the following needs careful consideration and evaluation:
- Increasing the number of training positions for general physician trainees. According to the most recent Medical Training and Review Panel report there were 84 geriatric medicine advanced trainees in Australia in 2007.²²⁴ Of these 84 specialist trainees, 29 were in NSW, which is an increase of 4 specialist trainees (16% increase) since 2006. In 2007, there were 967 Australian trainees in basic physician training programs/adult medicine, which provide the source of physicians who decide to specialise in geriatric medicine. Their number has increased by 158 trainees (19.5% increase) since 2006.²²⁵ Data from NSW shows that basic physician trainees have increased from 284.5 FTE in 2006 to 353 FTE in March 2008, an increase of 68.5 FTE or 24.1%.²²⁶ The Royal Australasian College of Physicians (RACP) has said it is short of approximately 50 registrar positions for general physicians.
 - Increasing remuneration. One geriatrician recommended that their pay scale with NSW Health be changed from Level 1 to Level 4, conferring an additional \$30,000 to \$40,000 per annum in salary.²²⁷ A submission has been made in this regard to NSW Health to allow departments to negotiate special financial arrangements with their area health services to facilitate recruitment and retention of staff. This is a matter which merits consideration by NSW Health as one option to improve working conditions to attract more trainees to become geriatricians.

- Implementing an Electronic Medical Record.

Lack of psychogeriatric beds

- 3.134 I was told that a shortage of aged care specialist medical and nursing staff makes it significantly more difficult to provide appropriate care to psycho-geriatric patients, who need to be cared for by staff with specialist training. Care must also be provided in the right place - in many cases these patients need to be treated in dedicated psycho-geriatric hospital wards, of which there are only 24 in NSW.²²⁸ The Inquiry received a number of submissions about this problem:
- In submissions from clinicians from the North Coast Area Health Service, I was told about a lack of specialised aged-care wards in public hospitals for confused elderly patients.²²⁹ Psycho-geriatric patients who are too frail to be cared for in psychiatric wards are often treated in medical wards, which are not purpose-built for safety and security and do not cater to the needs of people suffering from mental impairment.²³⁰ After the restructure of the area health services in 2004, the North Coast Area Health Service no longer has access to a CADE (Confused and Disturbed Elderly) unit. I was told that this is problematic, given that 20% of the North Coast population is over 65 years.
 - The Confused and Disturbed Elderly unit at Queanbeyan Hospital, which served parts of the Greater Southern Area Health Service has also been closed.²³¹
 - At James Fletcher Hospital in Newcastle, I was told that there is a shortage of beds to manage older patients with psychiatric problems and dementia patients with behavioural problems. It was submitted to the Inquiry that these patients should not be accommodated together.²³²
 - An endorsed enrolled nurse from Tamworth²³³ made a submission expressing concern that the shortage of nursing staff has impacted on the quality of care of patients with dementia. I was told that at Tamworth Hospital, "domestic staff, porters and security staff" are offered overtime shifts to act as "specials" for certain types of patients who require constant observation (eg patients with dementia or psychiatric patients). I was told that use of these staff is considered suboptimal and that if there is no other resource available, it is the only way in which managers can provide some assistance to the staff caring for the patient.
- 3.135 This is not an isolated occurrence. The Inquiry received a number of submissions about the increasing use of security guards to assist in the care of patients. Dr John O'Callaghan, Consultant Physician in Geriatric Medicine at Coffs Harbour Health Campus, informed the Inquiry that increasingly, security guards are used to assist in the care of older patients with confusion and delirium.²³⁴ He said that clinicians are told that there are not sufficient funds to employ more nursing staff to provide specialised care. Dr O'Callaghan informed the Inquiry that Coffs Harbour Hospital spent more than \$200,000 in the 2006 and 2007 financial year on security guards for inpatients. NSW Health told the Inquiry that the total cost of contracted security services for the Coffs Harbour Health Campus was \$360,602.²³⁵ The costs allocated to 'security specials' was \$188,882.²³⁶ Security specials are dedicated security officers who guard aggressive, confused or wandering patients both within the Emergency Department and inpatient wards.

Importance of Electronic Medical Record

- 3.136 The need for a centralised medical record for the treatment of elderly patients is self-evident: they commonly have multiple medical conditions, require multiple admissions to hospital, require numerous investigations, as well as regular attendances at a general practitioner, community health, and specialists, all of who are treating the same person and all of who require access to medical records.
- 3.137 On an ad hoc basis, various hospitals and communities have established databases for elderly patients. For example, the geriatric unit at Westmead Hospital developed a database to support its Commonwealth-funded Aged Care Program. The database contains discharge summaries and outpatient letters for patients in the program, which is approximately 20-30% of patients in the geriatric unit. The database can be accessed from anywhere within the hospital.²³⁷ Clearly there is a need for this technology to be introduced across the state so that individual area health services are not required to continually duplicate records, and so enhance the effectiveness of the system.
- 3.138 Whilst the utility of an Electronic Medical Record for all patients is, to me, obvious; the usefulness of such a record is further emphasised in the case of chronic, complex and elderly patients.

-
- ¹ Briefing by NSW Health dated 6 August 2008, p. 1.
 - ² Briefing by NSW Health dated 6 August 2008, p. 1.
 - ³ Australian Institute of Health and Welfare, Chronic Diseases, 2006, http://www.aihw.gov.au/cdarf/diseases_pages/index.cfm (18 November 2008).
 - ⁴ NSW Health Briefing, *Special Commission of Inquiry Presentations: Severe Chronic Disease Management Program*, 2 July 2008, p. 10.
 - ⁵ NSW Health Briefing, *Special Commission of Inquiry Presentations: Severe Chronic Disease Management Program*, 2 July 2008, p. 10.
 - ⁶ NSW Health Briefing, *Special Commission of Inquiry Presentations: Severe Chronic Disease Management Program*, 2 July 2008, p. 10.
 - ⁷ NSW Health Briefing, *Special Commission of Inquiry Presentations: Severe Chronic Disease Management Program*, 2 July 2008, pp. 10-11.
 - ⁸ NSW Health Briefing, *Special Commission of Inquiry Presentations: Severe Chronic Disease Management Program*, 2 July 2008, p. 12.
 - ⁹ Australian Institute of Health & Welfare, Chronic Disease and Associated Risk Factors in Australia, 2006, Canberra, p. ix, <http://www.aihw.gov.au/publications/phe/cdarfa06/cdarfa06-c00.pdf> (18 November 2008).
 - ¹⁰ Briefing by NSW Health dated 19 September 2008, p. 2.
 - ¹¹ Briefing by NSW Health dated 19 September 2008, p. 2.
 - ¹² Briefing by NSW Health dated 6 August 2008, p. 1.
 - ¹³ Briefing by NSW Health dated 6 August 2008, p. 1.
 - ¹⁴ Meeting with Australian Health Policy Institute, 11 April 2008, transcript 8.37-42.
 - ¹⁵ Sharon Miskell, Royal North Shore Hospital hearing, 2 April 2008, transcript 1262.3-8.
 - ¹⁶ Briefing by NSW Health dated 19 September 2008, p. 2.
 - ¹⁷ Submission of Dr Andrew Pesce on behalf of the Westmead Medical Staff Council, 2 April 2008, SUBM.013.0089 at 95.
 - ¹⁸ Submission of Dr Andrew Pesce on behalf of the Westmead Medical Staff Council, 2 April 2008, SUBM.013.0089 at 95.

-
- 19 Brian Grant, Liverpool hearing, 17 April 2008, transcript 1845.33-37.
- 20 Brian Grant, Liverpool hearing, 17 April 2008, transcript 1845.38.
- 21 Brian Grant, Liverpool hearing, 17 April 2008, transcript 1846.2-4.
- 22 Brian Grant, Liverpool hearing, 17 April 2008, transcript 1846.6-8.
- 23 Dr Michael Brydon, Sydney Children's Hospital hearing, 19 May 2008, transcript 3049.23-28.
- 24 Meeting with Australian Health Policy Institute, 11 April 2008, transcript 9.34-37.
- 25 Meeting with Australian Health Policy Institute, 11 April 2008, transcript 9.37-41.
- 26 Meeting with Australian Health Policy Institute, 11 April 2008, transcript 10.35-37.
- 27 Meeting with Australian Health Policy Institute, 11 April 2008, transcript 10.37-42.
- 28 Submission of NSW Health, 1 April 2008, SUBM.075.0002 at 127.
- 29 Sustainable Access Health Priority Taskforce Briefing, 5 June 2008.
- 30 Submission of NSW Health, 1 April 2008, SUBM.075.0002 at 125.
- 31 NSW Health, NSW Chronic Care Program, *Strengthening general practitioner involvement in chronic care, Review and recommendations*, 2005, NSW Health, North Sydney.
- 32 NSW Health, NSW Chronic Care Program, *Strengthening general practitioner involvement in chronic care, Review and recommendations*, 2005, NSW Health, North Sydney.
- 33 Briefing by NSW Health dated 19 September 2008, p. 4.
- 34 Briefing by NSW Health dated 19 September 2008, pp. 3-21.
- 35 Letter from NSW Health to Special Commission of Inquiry, 14 November 2008.
- 36 Briefing by NSW Health dated 19 September 2008, pp. 6-7.
- 37 Briefing by NSW Health dated 19 September 2008, p. 4; NSW Health Briefing, *Special Commission of Inquiry Presentations: Severe Chronic Disease Management Program*, 2 July 2008, p. 9.
- 38 Briefing by NSW Health dated 19 September 2008, pp. 3, 5.
- 39 Briefing by NSW Health dated 19 September 2008, p. 5.
- 40 Submission of NSW Health, 1 April 2008, SUBM.075.0002 at 125.
- 41 Sustainable Access Health Priority Taskforce Briefing, *Special Commission of Inquiry Presentations: Sustainable Access Health Priority Taskforce*, 5 June 2008, p. 10.
- 42 Sustainable Access Health Priority Taskforce Briefing, *Special Commission of Inquiry Presentations: Sustainable Access Health Priority Taskforce*, 5 June 2008, p. 11.
- 43 Sustainable Access Health Priority Taskforce Briefing, *Special Commission of Inquiry Presentations: Sustainable Access Health Priority Taskforce*, 5 June 2008, pp. 16-17.
- 44 NSW Health, *NSW Chronic Care Program, Rehabilitation for Chronic Disease, Volume 1*. NSW Health, Sydney, 2006, p. iii.
- 45 Submission of NSW Health, 1 April 2008, SUBM.075.0002 at 127.
- 46 Kathleen Harrison, Westmead hearing, 26 May 2008, transcript 3152.21-23.
- 47 Kathleen Harrison, Westmead hearing, 26 May 2008, transcript 3153.5-17.
- 48 Kathleen Harrison, Westmead hearing, 26 May 2008, transcript 3153.32-3154.2.
- 49 Kathleen Harrison, Westmead hearing, 26 May 2008, transcript 3154.4-8.
- 50 Kathleen Harrison, Westmead hearing, 26 May 2008, transcript 3154.7-17.
- 51 Kathleen Harrison, Westmead hearing, 26 May 2008, transcript 3154.19-21.
- 52 Kathleen Harrison, Westmead hearing, 26 May 2008, transcript 3154.30-33.
- 53 Kathleen Harrison, Westmead hearing, 26 May 2008, transcript 3160.7-17.
- 54 Kathleen Harrison, Westmead hearing, 26 May 2008, transcript 3160.24-30.
- 55 Kathleen Harrison, Westmead hearing, 26 May 2008, transcript 3156.39-3157.4.
- 56 Kathleen Harrison, Westmead hearing, 26 May 2008, transcript 3157.4-5.
- 57 Kathleen Harrison, Westmead hearing, 26 May 2008, transcript 3154.35-45.

- 58 Kathleen Harrison, Westmead hearing, 26 May 2008, transcript 3154.47-3155.6.
- 59 Kathleen Harrison, Westmead hearing, 26 May 2008, transcript 3156.22-26.
- 60 Kathleen Harrison, Westmead hearing, 26 May 2008, transcript 3157.10-26.
- 61 Kathleen Harrison, Westmead hearing, 26 May 2008, transcript 3156.13-20.
- 62 Kathleen Harrison, Westmead hearing, 26 May 2008, transcript 3159.1-16.
- 63 Russell Pilcher, Port Macquarie hearing, 28 March 2008, transcript 1120.17-1121-23.
- 64 Submission of Jamie Gaffney, 1 April 2008, SUBM.040.0130.
- 65 Submission of Barbara Novak, undated, SUBM.047.0073 at 74.
- 66 Dr Peter Rankin, Lismore hearing, 28 April 2008, transcript 2215.44-2216.03.
- 67 Confidential submission, March 2008, SUBM.055.0231 at 231-232.
- 68 For example, Russell Pilcher, Port Macquarie hearing, 28 March 2008, transcript 1120.17-1121-23; submission of Jamie Gaffney, 1 April 2008, SUBM.040.0130; submission of Barbara Novak, undated, SUBM.047.0073.
- 69 *Framework for performance improvement in health*, Independent Pricing and Regulatory Tribunal of NSW (IPART), 2008, IPART, Sydney, p. 32.
- 70 *Framework for performance improvement in health*, Independent Pricing and Regulatory Tribunal of NSW (IPART), 2008, IPART, Sydney, p. 34.
- 71 *Framework for performance improvement in health*, Independent Pricing and Regulatory Tribunal of NSW (IPART), 2008, IPART, Sydney, p. 34.
- 72 *Framework for performance improvement in health*, Independent Pricing and Regulatory Tribunal of NSW (IPART), 2008, IPART, Sydney, p. 35.
- 73 *Framework for performance improvement in health*, Independent Pricing and Regulatory Tribunal of NSW (IPART), 2008, IPART, Sydney, p.35.
- 74 *Framework for performance improvement in health*, Independent Pricing and Regulatory Tribunal of NSW (IPART), 2008, IPART, Sydney, p.35.
- 75 *Framework for performance improvement in health*, Independent Pricing and Regulatory Tribunal of NSW (IPART), 2008, IPART, Sydney, p.35.
- 76 Roberts M, Leeder & Robinson T, "Nurse-led 24-h hotline for patients with chronic obstructive pulmonary disease reduces hospital use and is safe", (2008) 38 *Internal Medicine Journal* 334-340.
- 77 Meeting with Australian Health Policy Institute, 11 April 2008, transcript 6.3-12.
- 78 Information provided during visit to Dorrigo Multi-Purpose Service on 26 March 2008.
- 79 Submission of the Hospital in the Home Society (NSW), undated, SUBM.077.0013 at 14.
- 80 Submission of the Hospital in the Home Society (NSW), undated, SUBM.077.0013 at 14.
- 81 Submission of the Hospital in the Home Society (NSW), undated, SUBM.077.0013 at 14.
- 82 Caplan GA, Coconis J, Sayers A, Board N, "Does home treatment affect delirium? A randomised controlled trial of Rehabilitation of Elderly and Care at Home Or Usual Treatment (The REACH OUT Trial)", (2006) 35 *Age and Ageing* 60-65; Leff B, Burton L, Mader S, et al, "Hospital at home: feasibility and Outcomes of a program to provide hospital-level care at home for acutely ill older patients", (2005) 143 *Annals of Internal Medicine* 798-808; Caplan GA, "Does Hospital in the Home treatment prevent delirium?", (2008) 4(1) *Ageing Health* 69-74.
- 83 Caplan G, Ward J, Brennan N, Board N, Coconis J, Brown A, "Hospital in the Home: a randomised controlled trial", (1999) 170 *Medical Journal of Australia* 156-160.
- 84 Submission of the Hospital in the Home Society (NSW), undated, SUBM.077.0013 at 15.
- 85 Submission of the Hospital in the Home Society (NSW), undated, SUBM.077.0013 at 15.
- 86 Board N, Brennan N, Caplan G, "A randomised controlled trial of the costs of hospital as compared with hospital in the home for acute medical patients", (2000) 24 *Australian and New Zealand Journal of Public Health* 305-311; Wilson SF, Shorten B and Marks R, "Costing the ambulatory episode: implications of total or partial substitution of hospital care", (2005) 29(3) *Australian Health Review* 360-365.

-
- 87 Submission of the Hospital in the Home Society (NSW), undated, SUBM.077.0013 at 15.
- 88 Nicholas Marlow, Royal North Shore Hospital hearing, 14 March 2008, transcript 317.3-331.31.
- 89 Submission of the Hospital in the Home Society (NSW), undated, SUBM.077.0013 at 13.
- 90 Nicholas Marlow, Royal North Shore Hospital hearing, 14 March 2008, transcript 327.19-21.
- 91 Submission of the Hospital in the Home Society (NSW), undated, SUBM.077.0013 at 15-16.
- 92 Submission of the Hospital in the Home Society (NSW), undated, SUBM.077.0013 at 15-16.
- 93 Submission of the Hospital in the Home Society (NSW), undated, SUBM.077.0013 at 16.
- 94 Nicholas Marlow, Royal North Shore Hospital hearing, 14 March 2008, transcript 327.12-14.
- 95 Professor Gideon Caplan & Dr Nicholas Collins, Sydney Children's Hospital hearing, 19 May 2008, transcript 3040.32-38.
- 96 Professor Gideon Caplan, Sydney Children's Hospital hearing, 19 May 2008, transcript 3038.44-3039.3.
- 97 Professor Gideon Caplan, Sydney Children's Hospital hearing, 19 May 2008, transcript 3043.10-16.
- 98 Professor Gideon Caplan, Sydney Children's Hospital hearing, 19 May 2008, transcript 3039.18-28.
- 99 Professor Gideon Caplan, Sydney Children's Hospital hearing, 19 May 2008, transcript 3039.18-28.
- 100 Professor Gideon Caplan, Sydney Children's Hospital hearing, 19 May 2008, transcript 3041.35-46.
- 101 The Audit Office of New South Wales, *Delivering health care out of hospitals: Department of Health (Performance audit)*, 2008, NSW Audit Office, Sydney.
- 102 The Audit Office of New South Wales, *Delivering health care out of hospitals: Department of Health (Performance audit)*, 2008, NSW Audit Office, Sydney, p. 2.
- 103 The Audit Office of New South Wales, *Delivering health care out of hospitals: Department of Health (Performance audit)*, 2008, NSW Audit Office, Sydney, p. 2.
- 104 The Audit Office of New South Wales, *Delivering health care out of hospitals: Department of Health (Performance audit)*, 2008, NSW Audit Office, Sydney, p. 2.
- 105 The Audit Office of New South Wales, *Delivering health care out of hospitals: Department of Health (Performance audit)*, 2008, NSW Audit Office, Sydney, p. 3.
- 106 The Audit Office of New South Wales, *Delivering health care out of hospitals: Department of Health (Performance audit)*, 2008, NSW Audit Office, Sydney, p. 4.
- 107 The Audit Office of New South Wales, *Delivering health care out of hospitals: Department of Health (Performance audit)*, 2008, NSW Audit Office, Sydney, p. 4.
- 108 Sustainable Access Health Priority Taskforce Briefing, *Special Commission of Inquiry Presentations: Sustainable Access Health Priority Taskforce*, 5 June 2008, p. 4.
- 109 Nichol B, Lonergan J, Mould M, *The Use of Hospitals by Older People: A Casemix Analysis*, June 2000, Occasional Papers: New Series No 11, DRG Development Section Acute and Coordinated Care Branch, Commonwealth Government, Canberra: referred to in Submission of Anna Moehead, 24 March 2008, SUBM.012.0330 at 330.
- 110 NSW Treasury, *Budget Estimates 2008-09* (Minister for Health), http://www.treasury.nsw.gov.au/__data/assets/pdf_file/0012/11424/bp3_12health_n.pdf (29 September 2008), p. 12-10.
- 111 NSW Treasury, *Budget Estimates 2008-09* (Minister for Health), http://www.treasury.nsw.gov.au/__data/assets/pdf_file/0012/11424/bp3_12health_n.pdf (29 September 2008), p. 12-10.
- 112 Scott Wagner and Hazel Bridgett, public hearing at the Inquiry's offices via video-link from Lismore, 30 May 2008, transcript 3278.36-38.
- 113 Scott Wagner and Hazel Bridgett, public hearing at the Inquiry's offices via video-link from Lismore, 30 May 2008, transcript 3278.38-43.
- 114 Confidential submission, 11 June 2008, SUBM.074.0064 at 67.

- 115 Confidential submission, 11 June 2008, SUBM.074.0064 at 66; Some of these terms also seem to have entered the lexicon in 1979 with the publication of Samuel Shem's classic novel: *The House of God*. Samuel Shem was an alias for Stephen Bergman M.D. who was a graduate of the Harvard Medical School.
- 116 Dr Clair Langford, Wollongong hearing, 14 April 2008, transcript 1688.32; Submission of the Australian Association of Social Workers (NSW Branch), 27 March 2008, SUBM.004.0078 at 81: "Unfortunately, [elderly] patients are often characterized as bed blockers and often made to feel unwelcome. The social workers who stand beside them also experience these pressures... These patients are entitled to care in a more appropriate and dignified setting. Solutions must be found to de-couple their care needs from the acute care system."
- 117 Confidential submission, 11 June 2008, SUBM.074.0064 at 66.
- 118 Confidential submission, 11 June 2008, SUBM.074.0064 at 66.
- 119 Confidential submission, 11 June 2008, SUBM.074.0064 at 66.
- 120 Mary Salagari, Wagga Wagga hearing, 22 April 2008, transcript 1984.36-46.
- 121 Confidential submission, 11 June 2008, SUBM.074.0064 at 66.
- 122 Submission of Anna Moehead, 24 March 2008, SUBM.012.0330 at 330.
- 123 A healthy person in bed for a week will lose about 30% of their muscle mass: Professor Jenó Marosszéký, Westmead hearing, 10 April 2008, transcript 1569.34-36.
- 124 Professor Jenó Marosszéký, Westmead hearing, 10 April 2008, transcript 1569.34.
- 125 Dr Steven Faux, St Vincent's Hospital hearing, 30 April 2008, transcript 2485.30-36.
- 126 Creditor MC, "Hazards of Hospitalization of the Elderly", (1993) 118 *Annals of Internal Medicine* 219-223, cited in NSW Health, *Clinical Services Redesign Program, Acute Care of the Elderly (ACE)*, 2006, NSW Department of Health, North Sydney, p. 9.
- 127 Dr Susan Kurrle, Hornsby Hearing, 11 March 2008, transcript 265.6-8, 24-26.
- 128 Submission of the NSW Branch of the Australasian Faculty of Rehabilitation Medicine (Royal Australasian College of Physicians), 27 March 2008, SUBM.013.0202 at 202.
- 129 Meeting with the Australian Medical Association and the Australian Salaried Medical Officers' Association on 23 June 2008.
- 130 Meeting with the Australian Medical Association and the Australian Salaried Medical Officers' Association on 23 June 2008.
- 131 Submission of Associate Professor Peter Lipski, 31 March 2008, SUBM.011.0231 at 232.
- 132 Submission of Associate Professor Peter Lipski, 31 March 2008, SUBM.011.0217 at 218.
- 133 Australian Healthcare Association, *E-Healthcare Brief*, Issue No. 070514-0717, http://www.aha.asn.au/newsletter/ehcb/070514_0717.html (22 November 2008); University of New South Wales, Media Release, *High rates of malnutrition in elderly*, 11 May 2007, <http://www.unsw.edu.au/news/pad/articles/2007/may/malnutrition.html> (20 October 2008).
- 134 Palmer RM, Counsell S and Landefeld CS, "Clinical Intervention Trials The Ace Unit", (1998) 14 *Clinics in Geriatric Medicine* 831-849, cited in NSW Health, *Clinical Services Redesign Program, Acute Care of the Elderly (ACE)*, 2006, NSW Department of Health, North Sydney, p. 9.
- 135 Submission of Jennifer Kercher, 18 April 2008, SUBM.043.0173 at 173.
- 136 Submission of Diane Roberts, SUBM.064.0176 at 176.
- 137 Submission of Christina Efthymiades, 6 April 2008, SUBM.040.0012 at 12.
- 138 Information provided during visit to St George Hospital on 21 February 2008.
- 139 Confidential Sydney Children's Hospital hearing, 19 May 2008.
- 140 Confidential Sydney Children's Hospital hearing, 19 May 2008.
- 141 Information provided during visit to Sutherland Hospital on 14 May 2008.
- 142 Associate Professor Peter Lipski, Gosford hearing, 10 March 2008, transcript 79.40-80.1.
- 143 As at 30 June 2007: Australian Institute of Health and Welfare (AIHW), *Residential aged care in Australia 2006-07: A statistical overview*, 2008, Cat. No. AGE 56, AIHW, Canberra, <http://www.aihw.gov.au/publications/age/raca06-07/raca06-07.pdf> (16 October 2008). The remoteness classification is based on the Australian Standard Geographical Classification

(ASGC) Remoteness Structure developed by the Australian Bureau of Statistics (ABS). It categorises all Census Collection Districts in Australia according to their remoteness, based on physical road distance to the nearest urban centre. For further information, see Census Paper No. 03/01, ABS website:

[http://www.abs.gov.au/Websitedbs/D3110122.NSF/0/f9c96fb635cce780ca256d420005dc02/\\$FILE/Remoteness_Paper_text_final.pdf](http://www.abs.gov.au/Websitedbs/D3110122.NSF/0/f9c96fb635cce780ca256d420005dc02/$FILE/Remoteness_Paper_text_final.pdf) (17 November 2008).

- ¹⁴⁴ Such as Community Aged Care Packages (CACP), flexible care provided through Extended Aged Care at Home Packages (EACH), Extended Aged Care at Home Dementia Packages (EACH Dementia), Innovative Care, and Transition Care Places (TCP). Access to assistance from each of these types of care requires approval from a multidisciplinary Aged Care Assessment Team (ACAT): Australian Institute of Health and Welfare, *Residential aged care in Australia 2006-07*, 2008, Cat. No. AGE 56, AIHW, Canberra, pp. 2-5.
- ¹⁴⁵ Australian Standard Geographical Classification (ASGC) Remoteness Structure, 2003 edition, Census Paper No. 03/01, pp.22-25. See ABS website, [http://www.abs.gov.au/Websitedbs/D3110122.NSF/0/f9c96fb635cce780ca256d420005dc02/\\$FILE/NSW&ACT_maps.pdf](http://www.abs.gov.au/Websitedbs/D3110122.NSF/0/f9c96fb635cce780ca256d420005dc02/$FILE/NSW&ACT_maps.pdf) (17 November 2008).
- ¹⁴⁶ Dr Richard Lindley, Westmead hearing, 10 April 2008, transcript 1592.21-25.
- ¹⁴⁷ Information provided during visits to Broken Hill Hospital on 7 May 2008, to Oberon Multi-purpose service on 17 March 2008, to Walgett District Hospital on 9 May 2008, to Rylstone Multi-purpose Service on 20 March 2008.
- ¹⁴⁸ Susan Saunders, Coffs Harbour hearing, 27 March 2008, transcript 1009.45-47; Information provided during visit to Oberon District Hospital on 17 March 2008.
- ¹⁴⁹ Dr Stephen Flecknoe-Brown, Broken Hill hearing, 7 May 2008, transcript 2652.32.
- ¹⁵⁰ Robert Hooper and Ian Weyland, Bathurst hearing, 17 March 2008, transcript 501.47-502.38.
- ¹⁵¹ Information provided during visit to Oberon District Hospital on 17 March 2008; Robert Hooper and Ian Weyland, Bathurst hearing, 17 March 2008, transcript 501.46-502.38.
- ¹⁵² Information provided during visit to Macksville District Hospital on 27 March 2008.
- ¹⁵³ Information provided during visit to Walgett District Hospital on 9 May 2008.
- ¹⁵⁴ Information provided during visit to Rylstone MPS on 20 March 2008.
- ¹⁵⁵ Dr Ian Incoll, Gosford hearing, 10 March 2008, transcript 47.19-25.
- ¹⁵⁶ Mary Salagari, Wagga Wagga hearing, 22 April 2008, transcript 1986.13-26.
- ¹⁵⁷ Vittorio Cintio, Nepean hearing, 8 April 2008, transcript 1376.24-42.
- ¹⁵⁸ Kathleen Dempsey, Westmead hearing, 26 May 2008, transcript 3151.20-3152.6.
- ¹⁵⁹ Vittorio Cintio, Nepean hearing, 8 April 2008, transcript 1377.9; Kathleen Gradidge, Nepean hearing, 8 April 2008, transcript 1420.2-19.
- ¹⁶⁰ Vittorio Cintio, Nepean hearing, 8 April 2008, transcript 1378.9. Kathleen Gradidge, Nepean hearing, 8 April 2008, transcript 1419.25-43.
- ¹⁶¹ Letter from NSW Health to Special Commission of Inquiry, 17 October 2008. The figure is calculated by using the average daily cost of providing inpatient care to a patient awaiting placement in a nursing home by NSW Health, which including depreciation is estimated to be \$616 per night.
- ¹⁶² NSW Health, "Transitional Aged Care", *Clinical Services Redesign Program*, 2006 [response to summons - DOH.028.0495].
- ¹⁶³ The Hon Justine Elliot MP, Minister for Ageing, Media Release, *Government working on \$158 million transition beds – getting elderly into appropriate aged care*, 25 March 2008 <http://www.health.gov.au/internet/ministers/publishing.nsf/Content/mr-yr08-je-je023.htm> (20 November 2008).
- ¹⁶⁴ The Hon Justine Elliot MP, Minister for Ageing, Media Release, *NSW Transition Care Places – helping up to 405 people a year return to their homes*, 12 September 2008 <http://www.health.gov.au/internet/ministers/publishing.nsf/Content/mr-yr08-je-je166.htm> (20 November 2008).
- ¹⁶⁵ The Hon Justine Elliot MP, Minister for Ageing, Media Release, *NSW Transition Care Places – helping up to 405 people a year return to their homes*, 12 September 2008

<http://www.health.gov.au/internet/ministers/publishing.nsf/Content/mr-yr08-je-je166.htm> (20 November 2008).

- 166 Kathleen Dempsey, Westmead hearing, 26 May 2008, transcript 3151.30-41.
- 167 Kathleen Gradidge, Nepean hearing, 8 April 2008, transcript 1470.21-26.
- 168 Mary Daly, Tweed Heads hearing, 29 April 2008, transcript 2366.33-34 (2 weeks to 3 months); Kathleen Gradidge, Nepean hearing, 8 April 2008, transcript 1470.36-40 (6 weeks).
- 169 Letter from Guardianship Tribunal to Special Commission of Inquiry, 1 October 2008.
- 170 Letter from Guardianship Tribunal to Special Commission of Inquiry, 1 October 2008.
- 171 Letter from the Director of Social Work Services for the Greater Newcastle Acute Hospital Network to Special Commission of Inquiry, 12 May 2008.
- 172 Letter from the Guardianship Tribunal to Special Commission of Inquiry, 1 October 2008.
- 173 Letter from the Guardianship Tribunal to Special Commission of Inquiry, 1 October 2008.
- 174 Commonwealth Department of Health and Ageing, NSW Health, *Protocols and Procedures Manual for ACATs in NSW 2007*, NSW Department of Health, 2007, North Sydney, p. iii [response to summons - DOH 015.0001 at 5].
- 175 Commonwealth Department of Health and Ageing, NSW Health, *Protocols and Procedures Manual for ACATs in NSW 2007*, NSW Department of Health 2007: North Sydney, p. viii-x [response to summons - DOH 015.0001 at 11].
- 176 Confidential Bankstown hearing, 13 May 2008, transcript 32.5.
- 177 Information provided during visit to Ballina District Hospital on 28 April 2008.
- 178 Kerry Shanahan, Mudgee hearing, 20 March 2008, transcript 754.10.
- 179 Confidential submission, 28 March 2008, SUBM.039.0003 at 4.
- 180 The Audit Office of New South Wales, *Helping Older People Access a Residential Aged Care Facility*, Performance Audit [NSW Health], December 2006, p. 18.
- 181 Dr Richard Lindley, Westmead hearing, 10 April 2008, transcript 1591.29-34.
- 182 Caplan G, Meller A, Squires B, Chan S, Willett W, "Advanced care planning and hospital in the nursing home", (2006) *Age and Ageing*, <http://ageing.oxfordjournals.org/cgi/reprint/af1063v1> (16 October 2008), p. 2.
- 183 Dr Richard Lindley, Westmead hearing, 10 April 2008, transcript 1591.32-34. Caplan G, Meller A, Squires B, Chan S, Willett W, "Advanced care planning and hospital in the nursing home", (2006) *Age and Ageing*, <http://ageing.oxfordjournals.org/cgi/reprint/af1063v1> (16 October 2008), pp. 3-4.
- 184 ASETs arose from research prepared by Dr Gideon Caplan at Prince of Wales Hospital: Submission of Dr Gideon Caplan, 28 March 2008, SUBM.016.0097 at 100.
- 185 Material provided by South Eastern & Illawarra Area Health Service (*Guidelines on implementation of Agedcare services Emergency Teams (ASETs) in Emergency Departments*, October 2002) in response to summons, SESI 014.0206 at 206.
- 186 NSW Health, *Overview of Planning: Response to AHS*, 2008, NSW Department of Health, North Sydney, p. 12 provided by NSW Health in response to summons, DOH.001.0008 at 019.
- 187 Letter from NSW Health to Special Commission of Inquiry, 3 October 2008.
- 188 Associate Professor Peter Lipski, Gosford hearing, 10 March 2008, transcript 77.29-32.
- 189 NSW Health, *Clinical Services Redesign Program Transitional Aged Care: GRACE (Geriatric Rapid Acute Care Evaluation)*, 2006, NSW Department of Health, North Sydney, p. 5 [response to summons - DOH.007.0036 at 40].
- 190 NSW Health, *Clinical Services Redesign Program Transitional Aged Care: GRACE (Geriatric Rapid Acute Care Evaluation)*, 2006, NSW Department of Health, North Sydney, p. 17 [response to summons - DOH.007.0036 at 52].
- 191 NSW Health, *Clinical Services Redesign Program Transitional Aged Care: GRACE (Geriatric Rapid Acute Care Evaluation)*, 2006, NSW Department of Health, North Sydney, p. 21 [response to summons - DOH.007.0036 at 56].

-
- ¹⁹² Dr Susan Kurrle, Hornsby hearing, 11 March 2008, transcript 261.16-18.
- ¹⁹³ Dr Susan Kurrle, Hornsby hearing, 11 March 2008, transcript 262.40-263.14.
- ¹⁹⁴ NSW Health, *Clinical Services Redesign Program Transitional Aged Care: GRACE (Geriatric Rapid Acute Care Evaluation)*, 2006, NSW Department of Health, North Sydney, p. 12 [response to summons - DOH.007.0036 at 48].
- ¹⁹⁵ NSW Health, *Clinical Services Redesign Program Acute Care of the Elderly (ACE)*, 2006, NSW Department of Health, North Sydney, p. 19.
- ¹⁹⁶ Northern Sydney Central Coast Area Health Services (NSCCAHS), *The Functional Alignment of Beds across the Northern Beaches Health Service: A clinical redesign process, Final Report*, 2007, NSCCAHS, p. 21.
- ¹⁹⁷ Confidential submission, 13 June 2008, SUBM.074.0070 at 72.
- ¹⁹⁸ Professor Richard Lindley, Westmead hearing, 10 April 2008, transcript 1586.37-1586.43.
- ¹⁹⁹ Verma R, NSW Health, *Health Care for Older People Earlier (HOPE) - Medical Assessment Unit*, 2007, NSW Health, p. 34 [response to summons - DOH.028.0549 at 587].
- ²⁰⁰ Verma R, NSW Health, *Health Care for Older People Earlier (HOPE) - Medical Assessment Unit*, 2007, NSW Health, p. 35 [response to summons - DOH.028.0549 at 588].
- ²⁰¹ Information provided during visit to Sutherland Hospital on 14 May 2008.
- ²⁰² Confidential Coffs Harbour hearing, 27 March 2008.
- ²⁰³ Confidential submission, 16 April 2008, SUBM.031.0059 at 62.
- ²⁰⁴ Confidential submission, 7 April 2008, SUBM.036.0087 at 94; Confidential submission, 16 April 2008, SUBM.031.0059 at 61.
- ²⁰⁵ NSW Health, *Clinical Services Redesign Program Transitional Aged Care: GRACE (Geriatric Rapid Acute Care Evaluation)*, 2006, NSW Department of Health, North Sydney, p. 12 [response to summons - DOH.007.0036 at 47].
- ²⁰⁶ NSW Health, *Clinical Services Redesign Program, Acute Care of the Elderly (ACE)*, 2006, NSW Department of Health, North Sydney, p. 14 [response to summons – DOH.007.0170 at 183].
- ²⁰⁷ Australian & New Zealand Society for Geriatric Medicine, *What is a Geriatrician? Defining what is a Consultant Physician in Geriatric Medicine*, p. 1, <http://www.anzsgm.org/documents/WhatisaGeriatrician-final.doc> (22 September 2008). Equivalent training is determined by relevant authorities, such as the Australian Medical Council (AMC), Health Insurance Commission (HIC) and the Royal Australasian College of Physicians (RACP). The large majority of geriatricians are members of the Australian Society for Geriatric Medicine.
- ²⁰⁸ NSW Health, *2006 Profile of the Medical Practitioner Workforce in NSW*, 2006, State Health Publication, Sydney pp. 74-76, cited in letter from NSW Health to Special Commission of Inquiry, 3 October 2008.
- ²⁰⁹ Letter from NSW Health to Special Commission of Inquiry, 4 November 2008.
- ²¹⁰ Professor Richard Lindley, Westmead hearing, 10 April 2008, transcript 1589.7-1590.3.
- ²¹¹ Submission of Associate Professor Peter Lipski, 31 March 2008, SUBM.011.0160 at 163.
- ²¹² Professor Richard Lindley, Westmead hearing, 10 April 2008, transcript 1590.6.
- ²¹³ Submission of Associate Professor Peter Lipski, 31 March 2008, SUBM.011.0160 at 163.
- ²¹⁴ Submission of Associate Professor Peter Lipski, 31 March 2008, SUBM.011.0160 at 163.
- ²¹⁵ Confidential submission, 7 April 2008, SUBM.036.0087 at 90.
- ²¹⁶ 'Fractured neck of femur', is medical jargon for a broken hip.
- ²¹⁷ Submission of Dr Michelle Bullmore and Dr Amanda Brownlow, 28 March 2008, SUBM.002.0210 at 210-211.
- ²¹⁸ Submission of Associate Professor Peter Lipski, 31 March 2008, SUBM.011.0023 at 29.
- ²¹⁹ Confidential submission, 11 June 2008, SUBM.074.0064 at 67.
- ²²⁰ Greater Metropolitan Clinical Taskforce (GMCT) Aged Care Network, *Orthogeriatric care – a collaborative model of care: Summary of information presented by the GMCT Aged Care Network's Orthogeriatric Liaison Working Party*, 21 January 2008, GMCT, Sydney,

http://www.health.nsw.gov.au/resources/gmct/agedcare/pdf/orthogeriatric_care_summary_2008.pdf (13 November 2008).

- 221 Moss J et al, "A multidisciplinary Care Coordination Team improves emergency department discharge planning practice" (2002) 177 *Medical Journal of Australia* 427.
- 222 Submission of Professor Peter Lipski, 3 March 2008, SUBUM.011.0160 at 167. The 3 initiatives are:
- (a) a more aggressive perioperative blood transfusion policy to prevent the complications of anaemia in Orthogeriatric patients;
 - (b) prioritizing the Orthogeriatric patient on the emergency operating list to avoid delays to theatre which increases complication rates; and
 - (c) improving osteoporosis treatment of the elderly which can reduce the fracture rate by 50%.
- 223 Confidential submission, 11 June 2008, SUBM.074.0070 at 71.
- 224 Medical Training and Review Panel (MTRP), *Eleventh Report*, 2007, Table C31, p. 85 cited in letter from NSW Health to Special Commission of Inquiry, 3 October 2008.
- 225 Medical Training and Review Panel (MTRP), *Eleventh Report*, 2007, Table 4.10, p. 51 cited in letter from NSW Health to Special Commission of Inquiry, 3 October 2008.
- 226 Institute of Medical Education and Training (IMET), *2007/08 Quarterly Survey*, cited in letter from NSW Health to Special Commission of Inquiry, 3 October 2008.
- 227 Confidential hearing at the Inquiry's offices, 13 June 2008, transcript 8.43-9.07.
- 228 There are also 62 older person mental health ambulatory service units and one community residential service unit. Letter from NSW Health to Clare Miller, Special Commission of Inquiry, 28 August 2008, tab 1 p. 7. Note also the NSW Service Plan for Specialist Mental Health Services for Older People 2005-2015 (http://www.health.nsw.gov.au/pubs/2006/pdf/older_ppl_summary.pdf) and the GMCT Aged Care Forum - 'Complex People in a Complex System?'
- 229 Submission of Anna Moehead OAM, 24 March 2008, SUBM.012.0330 at 330; Confidential submission, 26 March 2008, SUBM.005.0563.
- 230 Confidential submission, 26 March 2008, SUBM.005.0563.
- 231 Submission of Jillian Skinner, 9 April 2008, SUBM.050.0211 at 213.
- 232 Confidential submission, 24 April 2008, SUBM.044.0011.
- 233 Submission of Rozlyn Norman, 26 March 2008, SUBM.074.0087 at 89.
- 234 Submission of Dr John O'Callaghan, 23 April 2008, SUBM.028.0124 at 124.
- 235 Letter from NSW Health to Special Commission of Inquiry, 4 November 2008.
- 236 Letter from NSW Health to Special Commission of Inquiry, 4 November 2008.
- 237 Confidential hearing at the Inquiry's offices, 13 June 2008, transcript 10.26-40.

4 Mothers

Having a baby in NSW	78
A 'baby boom'	78
A range of facilities	78
Midwives	79
Training	79
Credentialing	80
Lack of midwives	80
Increased training positions	81
Medicare provider numbers	81
VMO-style contracts with NSW Health	82
Maternity models of care	82
NSW Health's attitude to maternity services	83
Caseload midwifery	84
Home birth	87
Loss of local maternity facilities	88

- 4.1 Three main issues arose in relation to the provision of maternity services in NSW:
- the lack of midwives,
 - different models of maternity care, and
 - the loss of local maternity facilities.
- 4.2 There were also a number of issues concerning midwives that arose in common with other nurses in NSW, which I have dealt with in Chapter 8. Such issues include understaffing, junior skill mix and lack of access to continuing education and training.

Having a baby in NSW

A 'baby boom'

- 4.3 NSW is currently experiencing a 'baby boom'. As the following graph indicates, the rate of birth in NSW was relatively steady from 2000 to 2006. From 2006 to 2007 the number of births increased significantly.¹

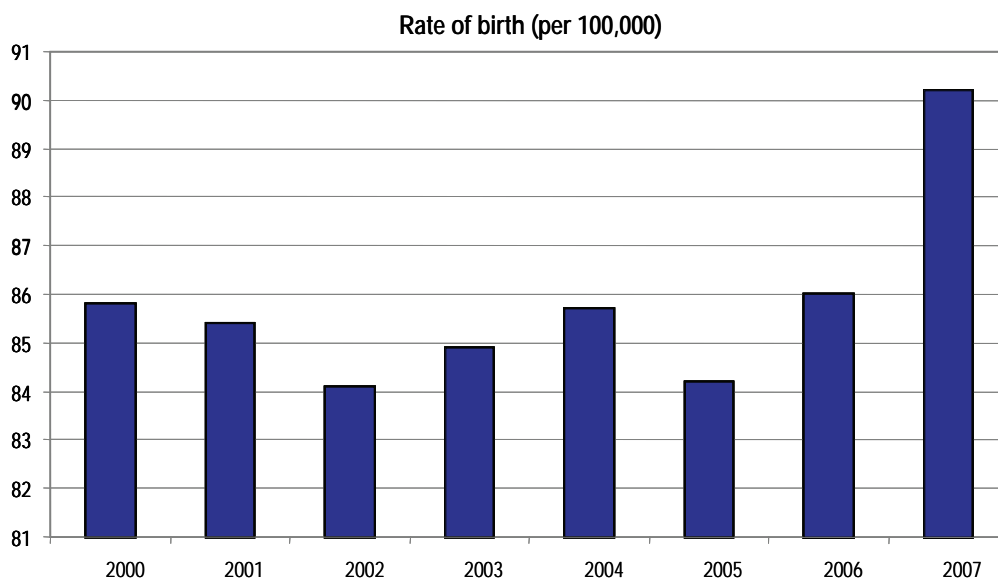

- 4.4 During the first 6 months of this year, there were 46,652 births in NSW, suggesting that the trend towards a higher birth rate is continuing.²

A range of facilities

- 4.5 There are presently 78 public hospitals offering maternity services in NSW.³ During the Inquiry, I saw a wide range of birthing facilities and it is clear that many hospitals are making a genuine effort to respond to the wishes of their local communities, including providing water birthing facilities and aromatherapy.
- 4.6 For instance, during my visits to Bellinger River District Hospital and Mullumbimby Hospital, I was told that maternity patients are provided with an holistic experience.⁴ The maternity unit at Mullumbimby has 3 rooms, including a water-birthing unit, which was provided in response to community demand.⁵ Indeed, I was told that the hospital

provides “whatever the community wants” in order to encourage patients to give birth at the hospital.⁶

- 4.7 At the other end of the spectrum, I visited several tertiary hospitals offering state-of-the-art facilities for mothers requiring caesarean births, accompanied by neo-natal intensive care units for babies born very prematurely or with serious medical conditions requiring major surgery shortly after birth (and, occasionally, before birth). I have discussed these facilities further in Chapter 5.
- 4.8 The service provided at Royal Prince Alfred Hospital in Sydney had the best of both worlds, offering the full range of maternity services – from a birthing centre with midwives, to operating theatres and facilities for emergency procedures. Royal Prince Alfred Hospital oversees approximately 5,000 births per year.⁷ Realistically, it would be impractical to establish similar centres in every hospital in NSW, as few towns have the number of births each year to support such a comprehensive service.

Midwives

- 4.9 Midwives provide support, care and advice during pregnancy, labour and after birth, as well as conducting births and providing care for newborns and infants.⁸
- 4.10 Registered midwives are registered in the Register of Midwives kept by the Nurses and Midwives Board of NSW.⁹ Registered midwives practise midwifery in various capacities in NSW public hospitals, including as clinical midwifery specialists, midwifery educators, clinical midwifery consultants, midwifery unit managers, and midwifery managers.

Training

- 4.11 The only undergraduate midwifery course in NSW is the Bachelor of Midwifery offered by The University of Technology, Sydney. Graduates may apply for registration as a midwife without having to become a registered nurse beforehand.¹⁰ The course takes 3 years and requires students to undertake clinical experience.¹¹ Final year students spend most of their time in the clinical environment,¹² and may complete a rural and remote placement.¹³
- 4.12 Registered nurses who wish to register to practice in midwifery can:
- (a) obtain a 12 to 15 month full-time Graduate Diploma in Midwifery offered by the University of Newcastle, the University of Western Sydney, The University of Technology, Sydney and Charles Sturt University;¹⁴ or
 - (b) complete a 12 month full-time Master of Science (Midwifery) offered by the University of Wollongong.¹⁵
- 4.13 One midwife told me that a lot of her midwife colleagues who trained in the hospital system are not entitled to the same level of “certificate allowance” as university-trained nurses.¹⁶ I was told this certificate allowance reflects the extra knowledge midwives have derived from their experience.¹⁷ In her words, hospital-trained nurses are not regarded as being “worth as much” as university-trained nurses:

“[W]e get the bare minimum of the allowance, despite the fact that I have been there for 21 years and I have more than 21 years experience. So someone who has just come out and who has had one year of experience or 3 years of experience is actually worth more to the system than I am, which I think is a gross inequity.”¹⁸

- 4.14 I note that NSW Health's Policy Directive 2007/86 confirms midwives' eligibility for a continuing education allowance under the *Public Health System Nurses' and Midwives (State) Award* where certain post-graduate qualifications have been completed, including some hospital-based certificates.¹⁹ It seems to me that the continuing education allowance is a valuable incentive for midwives to update their qualifications.

Credentialing

- 4.15 The *Midwives – NSW Health – Credentialing Framework* Policy Directive obliges area health services to ensure that midwives working in midwifery-managed models of care are credentialed.²⁰ Compliance with the Policy Directive is mandatory.²¹ The rationale for credentialing is:

"to optimise the quality and safety of maternity care through the provision of a skilled and competent midwifery workforce."²²

- 4.16 The credentialing process involves 4 steps:
- self assessment,
 - panel review,
 - workstation assessment, under which the midwife undergoes "workstation" assessments of selected maternity clinical emergencies, and
 - scenario-based assessment, which is designed to examine the midwife's critical thinking and decision-making capabilities.²³
- 4.17 Midwives have 12 months from starting work in midwifery to attain the credential, which is awarded for 3 years.²⁴ Area health services must then ensure that their midwives attain and maintain the credential.²⁵

Lack of midwives

- 4.18 The most recent data available to this Inquiry indicates that in 2005 there were 5,539 midwives working in NSW hospitals.²⁶
- 4.19 I was told by the Secretary of the NSW Midwives Association that the average age of a midwife is presently 47, and they are not being replaced in adequate numbers.²⁷ I have discussed the ageing of the nursing workforce in Chapter 8.
- 4.20 I was also told that there is a shortage of midwives.
- A midwife at Wollongong Hospital told me that since 2001, the number of births has increased from 1,900 to 2,300, patient acuity has increased, but the number of midwives has decreased.²⁸ This has led to an increased workload:

"Our full-time equivalents have been reduced since that time in all areas of midwifery. The acuity of patients has increased. Our caesarean section rates have increased. The amounts of epidurals we are doing have increased. We are asked to do more, for example, cannulation, suturing of perineums, that sort of thing. The role of the midwife has been extended."²⁹
 - A nurse at The Tweed Hospital expressed concern about the decreasing number of midwives available for full-time positions and the increasing average age of midwives.³⁰

- I was told by witnesses at Royal Prince Alfred Hospital that until February 2008, there were 9 full-time equivalent vacancies in the birth unit's workforce, and very little response to advertising.³¹
- 4.21 Witnesses informed me that registered nurses are being used to make up for the lack of midwives, although some midwives complained that registered nurses do not have the necessary training and thus require considerable supervision.
- A midwife at Wollongong Hospital told me that, because the hospital's birth unit is short of midwives, they are relying more and more on registered nurses.³² The witness regarded this situation as unsatisfactory, telling me that a registered nurse "cannot do the job" of a midwife.³³ The witness cited the following example:

"On a night shift just recently, a registered nurse could not help a woman breastfeeding, so when the day shift came on this woman was in huge problems. She was engorged, leading onto mastitis, which could have meant a longer length of stay. If she'd had a midwife looking after her, that midwife would have been able to get her over that problem and [the patient] would have been discharged a lot earlier."³⁴
 - A midwife at Sydney Children's Hospital told me that because the midwife "deficit" is being addressed by the use of registered nurses in many hospitals, the existing midwives are required to supervise people who do not have adequate training, and midwives are thus experiencing added stress.³⁵
- 4.22 Three main suggestions were made to deal with the shortage of midwives:
- (a) increased clinical placement positions,
 - (b) granting midwives Medicare provider numbers to enable them to be paid for maternity services provided outside the hospital, and
 - (c) NSW Health entering into VMO-style contracts with midwives.

Increased training positions

- 4.23 Whilst I heard evidence that there is keen interest in midwifery, only 30 to 40 students graduate from The University of Technology, Sydney each year.³⁶ I was also told that the university has turned students away because it cannot secure enough clinical places.³⁷
- 4.24 Further, a nurse at The Tweed Hospital told me that there are not enough midwifery training positions offered in NSW hospitals, and there is insufficient support for current students because of an absence of clinical midwifery educators.³⁸

Medicare provider numbers

- 4.25 Some witnesses suggested that midwives should be given Medicare provider numbers. This would allow private midwives to be paid by the Commonwealth Government for maternity services provided outside the hospital, including before and after the birth.³⁹ It was suggested to me that providing Medicare numbers to midwives would enable midwives to order essential tests related to care after birth, which is particularly relevant given the lack of maternity services in some rural communities.⁴⁰
- 4.26 Such a system has operated in New Zealand for 10 years.⁴¹

- 4.27 A witness from Sydney Children's Hospital told me that another option was for all midwives to be provided with a "16400 Medicare item", which would permit GPs to take midwives into their practices.⁴²
- 4.28 NSW Health supports the provision of access for midwives to specific Medicare items for routine screening of the minor ailments of pregnancy (including pathology and imaging) without recourse to a medical practitioner.⁴³
- 4.29 Medicare provider numbers are provided by the Commonwealth Government, which is considering a proposal to provide Medicare numbers to midwives for management of pregnancy, labour and delivery.⁴⁴ The Commonwealth has issued a Discussion Paper – *Improving Maternity Services in Australia*⁴⁵ – submissions in respect of which were due by 31 October 2008.⁴⁶
- 4.30 In any event, it is beyond my Terms of Reference to consider whether the Commonwealth Government should make such changes to Medicare.

VMO-style contracts with NSW Health

- 4.31 It was also suggested that NSW Health enter into VMO-style contracts with midwives, who would receive payment on a "fee for service" basis just as Visiting Medical Officers do in the public hospital system, and that this may assist in filling the "gaps" where maternity services are not provided by obstetricians or GPs.⁴⁷
- 4.32 Indeed, the Director-General of NSW Health, Professor Picone, frankly acknowledged to me that, for maternity services in rural areas,
- "the clear answer to that is to move to more midwifery and primary healthcare based models, in a country where obstetric practice has not allowed that to occur ..."⁴⁸
- 4.33 An analogy with this proposal can be found with the creation of Nurse Practitioner roles in rural and remote locations where medical coverage is not always available.
- 4.34 A representative of the Australian Society of Independent Midwives told me that midwives working in private practice could greatly assist in the expansion of one-to-one midwifery care.⁴⁹ This witness explained that under such a model, a private midwife who was practising in NSW could contract his or her services to the local area health service.⁵⁰ This would enable rural women to access services that are available virtually exclusively to women living in metropolitan areas.⁵¹ The witness observed that under this model, private midwives working under a VMO-style contract could work for both public and private clients.⁵²
- 4.35 I understand that hospitals employing midwives are indemnified under the NSW Treasury Managed Fund.⁵³ NSW Health, through the Treasury Managed Fund, provides indemnity to Visiting Medical Officers in respect of services provided under the auspices of NSW Health.⁵⁴ I understand that the extension of current indemnity arrangements to cover midwives would require approval from the Treasurer, both for the provision of indemnity and for the additional costs involved.⁵⁵

Maternity models of care

- 4.36 I heard evidence and received many submissions that advocated the further development of a greater range of maternity services in NSW, in particular, caseload midwifery and home births.

NSW Health's attitude to maternity services

- 4.37 In 2000, NSW Health developed *The NSW Framework for Maternity Services*, which is the guiding policy document for maternity services across NSW.⁵⁶ The framework recognises that women should be able to choose the type of care that they receive throughout pregnancy and childbirth, be it provided by an obstetrician, GP, midwife or a combination of these.⁵⁷ The framework states:

"There is a growing recognition of the desirability of offering a range of service options and models of practice in maternity services. Typically, such services are characterised by their distinctive adaptation to a local geographic area and the clinical needs and expressed preferences of the local population. They also demonstrate an appropriate balance between community and hospital-based care and the incorporation of shared care arrangements and private practice."⁵⁸

- 4.38 NSW Health has left it to the area health services to decide which particular types of maternity services will be provided in each area health service according to needs of the community. In this regard, the framework provides:

"Area Health Services need to use this framework to plan their individual services."⁵⁹

- 4.39 NSW Health has also developed a number of policy documents and directives to assist in implementing and regulating different models of maternity care. These include:
- *Models of Maternity Service Provision Across NSW: Progressing Implementation of the NSW Framework for Maternity Services*,⁶⁰
 - *Maternity – Public Homebirth Services*;⁶¹ and
 - *Primary Maternity Services in Australia – A Framework for Implementation*.⁶²

- 4.40 NSW Health's *Models of Maternity Service Provision Across NSW* recognises the diversity of maternity services provided in different area health services:

"Across the State a range of different models for maternity care have been developed through local or historical patterns based on the demand for services and availability of personnel.

... Across Area Health Services there are systemic differences in style, philosophy and resource intensity of care provided to similar groups of women by midwives, obstetricians and general practitioners."⁶³

- 4.41 Notwithstanding the wide range of maternity services endorsed by NSW Health, I received many submissions from people expressing their frustration with the slow progress of the area health services in providing a greater range of maternity services. The coordinator of Homebirth Access Sydney made the following comments in the context of area health services' adoption of (and, in some cases, failure to adopt) broader models of maternity care:

"The existing policies recognise the evidence supporting midwife led care for low-risk women. However, Area Health Services have been slow and in some cases apparently reluctant to act to provide these choices in practice.

"... [T]hese are services which represent excellent value for money and they are services which pregnant and birthing women in NSW want and deserve.

"It is hard to understand why the progress in this regard has been so slow. However, from the perspective of maternity consumers, it appears that a large part of the resistance appears to come from doctors, in particular those represented by the Royal Australian New Zealand College of Obstetricians and Gynaecologists (RANZCOG). Maternity consumers can only see that international evidence clearly supports expanding community based care for low-risk women. But this evidence has been discounted by what is essentially a trade union representing the professional interests of specialist doctors. RANZCOG has been remarkably successful in convincing successive governments to maintain the position of their members as the only providers of continuity of care for pregnant and birthing women in NSW.

"This not only flies in the face of evidence about best practice care for pregnant and birthing women but is essentially anti-competitive. Pregnant and birthing women deserve to have real choices about their care providers and the current system in NSW fails to facilitate such choice."⁶⁴

- 4.42 Another witness made the following comments in relation to the apparent reluctance of NSW Health to act in accordance with its policies on maternity services:

"NSW Health has delivered some effective policies in recent years. It has however largely been ignored. NSW Health does not enforce any of its policies. It merely leaves it 'sit and wait' for individual Area Health Services to enact. As such cost effective evidence based maternity care only exists if a benevolent obstetrician exists."⁶⁵

- 4.43 Two particular models of care were promoted to me as warranting greater adoption across the state: caseload midwifery and home births.

Caseload midwifery

- 4.44 Under the caseload model, a single midwife takes primary responsibility for the care of a set number of women.⁶⁶
- 4.45 I heard evidence and received submissions from many advocates for the caseload midwifery model, and I was directed to studies which suggest that the caseload model has many benefits.
- 4.46 The Australian Health Policy Institute reviewed the literature on caseload midwifery and concluded that it provides greater continuity of care (with patients seeing fewer staff) than conventional care, women prefer it, and it results in less interventionist deliveries.⁶⁷ Women had fewer epidurals, less foetal heart rate monitoring and fewer episiotomies, but more minor (unsutured) perineal tears.⁶⁸ Other demonstrated benefits were said to include less use of narcotics and augmentation of labour, lower caesarean rates and instrumental vaginal deliveries, a shorter second stage of labour and a shorter length of hospital stay, although such results were not consistently reported.⁶⁹
- 4.47 The researchers cautioned against making too much of the evidence, however, noting (amongst other matters) that few randomised controlled trials on caseload midwifery have been undertaken.⁷⁰ The researchers also noted that many of the studies were not sufficiently large to allow valid conclusions about maternal and neonatal safety to be made, given adverse outcomes are relatively rare.⁷¹ In this context, they noted:

"Although there is no evidence that midwifery-led care leads to poorer outcomes for mothers or babies, the overall lack of high level evidence and methodological weaknesses in existing studies means it is difficult to make firm conclusions about the safety of midwifery-led models."⁷²

4.48 An obstetrician at Liverpool Hospital told me that in his view, the caseload model of midwifery care, carefully governed, is safe.⁷³ He nevertheless conceded that under this model, mothers may not be able to access emergency services as they would like in some circumstances.⁷⁴

4.49 My attention was drawn to a number of regions where caseload midwifery is provided, with good results, or is being considered.

- About 250 births a year are dealt with through the midwifery service at Camden Hospital using a caseload model.⁷⁵ Each midwife takes 40 patients, which I am told is a comfortable number.⁷⁶ Whilst a primary midwife is nominated for each patient, there is also a secondary midwife nominated, who is sometimes known as a "buddy".⁷⁷ The second midwife's purpose is to assist the primary midwife in circumstances where the labour lasts more than 12 hours or where 2 patients are giving birth at the same time.⁷⁸
- In March 2004 the Ryde Midwifery Group Practice was established at Ryde Hospital on the caseload model.⁷⁹ The first evaluation of the safety and effectiveness of caseload midwifery care within the practice supported it as a safe alternative to tertiary hospital-based obstetric care.⁸⁰ The evaluation noted that the model lowered the cost of maternity care.

"The Ryde Midwifery Group Practice demonstrated a considerable cost saving to the Area Health Service. These savings are based on reduction of medical costs by a factor of 84.6% [and] an increase in productivity in midwifery resources by 43.5% [There was] a decrease in the use of accelerants for labour (syntocinon and prostaglandins) with spontaneous onset of labour increasing from 53.5% to 82.7%. [There was] a decrease in the use of pharmacological methods for pain relief during labour. The percentage of women not requiring pharmacological pain relief increased from 11% to 55.8%. [There was] a decrease in post-natal bed stays from 3.4 days to 2.5 bed days representing a 30% reduction in post-natal length of stay in hospital."⁸¹

- A midwifery group practice operating on a caseload model was established at Adelaide's Women's and Children's Hospital in January 2004.⁸² Under this model, women are cared for by a lead midwife (who provides most of their care), and a support midwife (who provides care when the lead midwife is unavailable).⁸³ Midwives also maintain relationships with a variety of primary and specialist health care providers.⁸⁴ An evaluation of this program concluded:

"[The model] has demonstrated a level of care that benefits women, babies and midwives. The clinical effectiveness demonstrates the ability of this model of care to provide a high-level of care with good outcomes for women and babies, across all risk groups. The satisfaction of women receiving care within this model has been particularly high, with a corresponding increase in demand for the service. The midwives working in the [Midwifery Group Practice] are also satisfied with their role, which mirrors the high levels of midwife satisfaction found in other studies of similar models of care... ."⁸⁵

4.50 Against this, I heard evidence from a number of experienced midwives that the caseload model would not be suitable for them, either because of the sheer number of births in their hospitals, or their need for certainty of working hours.

- A midwife who works at Blue Mountains Hospital told me that caseload midwifery would impact significantly on her home life, because she would be required to make herself more available.⁸⁶ It was “not [her] cup of tea”.⁸⁷ She confirmed that caseload midwifery is not universally embraced by midwives for lifestyle reasons:

“I think a lot of it probably has a lot to do with the impact it would have on their lifestyle. For some people, like me, who trained in the hospital system and are of the old school, as they say, that’s what we’re comfortable with; we’re not comfortable with going out to people’s homes and doing that sort of thing and so, therefore, we chose not to do the midwifery at home program ... [W]e want to come to work, know when we have to be available, when we get to leave, and all that sort of stuff. But there are people – and I think they are probably a lot of the recent trainees ... who would be happy to do that sort of thing.”⁸⁸

- A Clinical Nurse Specialist in the labour ward of Nepean Hospital told me that in her view, the caseload model of midwifery would not be easy for Nepean’s 3,700 births per year.⁸⁹

Indeed, one advocate of the caseload midwifery model of care acknowledged that there are different levels of competence within the midwifery workforce, and a number of midwives would not be immediately suitable for work in a caseload practice.⁹⁰

4.51 I have a real concern about whether there are enough midwives presently working, or available to work, in NSW to provide the caseload model in every hospital across the state which presently provides maternity services. This is principally because it would have to be offered in conjunction with the existing “shift” model. However, there may be some hospitals where the numbers of births would allow the model to be offered in lieu of the current 24 hour a day, 7 day a week shift system.

4.52 Differing views were expressed to me on this score.

- The Professor of Women’s Health, Nursing and Midwifery at UTS conceded that if the current model of midwifery was to be retained, in addition to providing women with a caseload model, there would need to be an increase in the number of midwives.⁹¹
- An obstetrician likewise told me that under a caseload model of midwifery care, staffing has to be good.⁹² He observed that if the scope of the model is too big, then the caseload may become impersonal.⁹³ On the other hand, if the model’s scope is too small, midwives will not be used sufficiently, nor be allowed to maintain their skill levels.⁹⁴ This has costs implications.⁹⁵
- So too, a registered nurse at Armidale Hospital described the caseload model of midwifery as a “wonderful system”, subject to the following reservation:

“[T]he problem here is that there is not enough of us to go around to be able to do something like that.”⁹⁶

4.53 Whilst the caseload model has many attractive features, and seems desirable if the expectant mother wants it and midwives wish to work in this way, I am not prepared to recommend that NSW Health offer caseload midwifery in every hospital across NSW given the workforce problems identified in this chapter. However there is room for the model on an individual hospital basis where clinically appropriate.

Home birth

- 4.54 During the Inquiry, several witnesses requested that NSW Health provide midwives for home births.
- A witness at Coffs Harbour said that she would like to see publicly-funded home birth midwives, as there is a large home-birthing population in the north coast area.⁹⁷ She made the following comments in this context:

“If you want to have a home birth, attended by a hospital midwife, you need to be in the Hunter Valley or parts of Sydney. It seems very strange that in a part of the state where most of the alternate lifestylers and fans of home birth are, we are denying them that opportunity as a model of care. We would like to see the health service investigate that as a priority because we have strong anecdotal evidence of women going without any care, what they call free-birthing, which is obviously very risky and hazardous, and it’s not taking into account the community’s need.”⁹⁸
 - At Mullumbimby there is a large “alternative lifestyle” community, and there are about 100 home births each year that Mullumbimby Hospital has no involvement with at all.⁹⁹ In order to meet community demand for home birth services, the hospital has submitted a proposal to permit interested midwives who are staff members of the hospital to supervise home births as part of their hospital duties.¹⁰⁰
 - I have also been informed that although Royal Prince Alfred Hospital does not oversee home births, this is being considered as there is some community demand for it.¹⁰¹
 - A midwife at Nepean Hospital made the following, similar comments in relation to the need for midwifery support in the Blue Mountains and northern NSW:

“[T]here is an increasing number of women, particularly in the mountains, who are doing what they call unassisted or free-birthing, without any medical or midwifery support there at all. It is growing in numbers I believe because there is not a publicly funded, safe and professional home birth model of care in the mountains, and I would argue that the mountains and northern NSW are probably two hotspots that would absolutely absorb such a service if it was available.”¹⁰²
- 4.55 NSW Health already recognises the right of women to give birth at home if they choose. The *Maternity – Public Homebirth Services Policy Directive* states:
- “NSW Health recognises the place of birth as a decision for women and their families and that a small number of these women will choose to birth at home.”¹⁰³
- 4.56 NSW Health already recommends that area health services make arrangements for a range of models of care that may include public home birth services, and prescribes the following comprehensive requirements for such services:
- (a) Home birth services must comply with the standards set in the *Maternity – Public Homebirth Services Policy Directive* regarding safety and risk minimisation, continuity of care, competence of the workforce, and monitoring and evaluation (amongst other matters).¹⁰⁴
 - (b) Midwife clinicians are to be present at each birth at home.¹⁰⁵
 - (c) Clinicians providing public home birth services must be employees of, or have clinical privileges with area health services, and all midwives must be credentialed in accordance with NSW Health’s policies.¹⁰⁶

- (d) Clinicians providing home birth services are required to comply with all incident reporting requirements of NSW Health.¹⁰⁷
- 4.57 There are a number of publicly-funded home birth systems in NSW run by area health services.
- In Hunter New England Area Health Service, the main home-birthing service is at Belmont, which commenced on 18 December 2007.¹⁰⁸ The Belmont service is a stand-alone midwifery-managed service staffed by 7 midwives and one manager.¹⁰⁹ As at 16 October 2008, the service had assisted 21 women who successfully gave birth at home, while one woman was transferred to hospital.¹¹⁰
 - In December 2007, home birth services also commenced in Tamworth and Taree, both of which are staffed by one midwife and have overseen 2 home births.¹¹¹
 - In South Eastern Sydney Illawarra Area Health Service, 7.78 full-time equivalent midwives staff the home birth program run out of the Home Birth Centre at St George Hospital.¹¹² This program has overseen 49 home births.¹¹³ I am told that the St George service had 6 transfers during the birth and 23 transfers after the birth or cancellations (for reasons such as the mother's decision to birth elsewhere).¹¹⁴
 - Publicly-funded home birth services are to be provided in the Northern Illawarra area from January 2009.¹¹⁵
- 4.58 I was told that these home birth programs are becoming extremely popular.¹¹⁶ Certainly, the *Evaluation of the Publicly-Funded Home Birth Program in South East Sydney Illawarra AHS* recommended that the program continue and be expanded.¹¹⁷
- 4.59 I am extremely concerned about the risks posed to mother and baby if a home birth becomes complicated and urgent medical help cannot be provided in time to prevent death or disability to mother or baby. However, I appreciate why permitting a NSW Health employed midwife to oversee a birth is far more preferable than the alternative which is that some mothers are choosing to give birth at home without any medical or midwifery support at all. As one nurse put it, at The Tweed Hospital:
- "With deliveries in the home, ... you have to be extremely selective about your clients and the criteria for excluding them as well as access to the hospital. They have to be within a radius that is close by the hospital if you strike any complications... [T]here will always be a small number of ladies who will develop some complications, but again it would have to be well-trained and competent midwives who would take on that position. They do have to be trained for that, but it is not impossible."¹¹⁸
- 4.60 It seems to me that NSW Health has already developed the policy framework to enable home birth services to be provided, and it is appropriately a matter for each area health service to decide whether its local communities want such a service, and whether the area health service has the resources to provide it. I am not prepared to require by a recommendation that all area health services must do so.

Loss of local maternity facilities

- 4.61 Concern was expressed to me during the Inquiry's public hearings that the number of maternity wards has decreased considerably in NSW in recent years, requiring mothers to travel considerable distances to give birth.

- 4.62 For example, a registered nurse at Wollongong Hospital told me that small maternity units around the Illawarra have closed over the last 15-20 years, including those at Bulli, Port Kembla, Kiama and Shellharbour Hospitals.¹¹⁹ While the southern suburbs of the Illawarra have the second largest growth rate in NSW and more than a third of women giving birth at Wollongong Hospital come from those suburbs,¹²⁰ these suburbs have limited maternity services.¹²¹ She also told me that in 1995 there were 50 maternity beds in the Illawarra and in 2008 there are 25, notwithstanding that the birth rate has been stable.¹²²
- 4.63 A reduction in the number of maternity beds poses the risk of women giving birth *en route*, made greater by the fact that ambulance paramedics are not licensed to carry oxytocic drugs such as Syntocinon, which can be used in various treatments after birth.¹²³
- 4.64 It certainly did appear to me that maternity units at large metropolitan and regional hospitals were working at or beyond their capacity. For instance, I was informed that the birth rate at The Tweed Hospital is 1,200 births per year, which is double the hospital's 2002 birth rate.¹²⁴
- 4.65 There is Australian research which demonstrates that small maternity units are as safe as referral hospitals for low-risk pregnancies.¹²⁵ In reaching this conclusion, the researchers observed:

"These results challenge the view that small hospitals are not a safe place for women with uncomplicated pregnancies to give birth. In the absence of economic analysis, when perinatal birth outcomes are considered the evidence that low hospital volume predicts poorer maternal and child outcomes is not upheld."¹²⁶

- 4.66 However, I was also told about international research which apparently suggests that deaths of mothers and babies increase in small delivery suites. An obstetrician at Nepean Hospital told me that French data indicates that maternal mortalities and foetal mortalities rise when a delivery suite does less than 2,000 births a year.¹²⁷ He told me that post-partum haemorrhages were more common in those circumstances.¹²⁸ He noted that problems can arise with maternity services in small rural hospitals, in particular for caesarean sections.¹²⁹ In this context, he observed:

"[T]he depth of clinical experience and the depth of reserves to assist in those very difficult problems is much less."¹³⁰

In his view, in metropolitan areas the balance between the distance from home and the safety of care being provided to mothers and babies should fall in favour of safety.¹³¹

- 4.67 The Australian Health Policy Institute's *Review of the Evidence on Alternative Models of Care* also expressed concern about the difficulties in classifying a woman's risk status:

"Currently there is little evidence on how to accurately assess risk and respond to an increasing risk status, particularly during labour.

... Concerns about the safety of various midwifery models for high risk women may be allayed if much clearer guidelines and procedures for risk assessment can be developed."¹³²

- 4.68 It was readily conceded by witnesses to this Inquiry that women who were identified during their pregnancies as other than 'low risk' **should** travel whatever distance is required to give birth at a hospital with the necessary specialists and facilities, such as

obstetricians, anaesthetists and operating theatres, in the event that a caesarean section is needed. Obviously, whilst it may be very inconvenient for such mothers and their families to travel long distances for the birth of a new baby, it is far less traumatic than the death of a mother and / or baby, or a life-changing injury to a baby, as a result of a disastrous birth without access to obstetric services.

4.69 As I understand it, the debate is centred on whether local hospitals which do not have the workforce or facilities needed for an emergency caesarean should remain available for 'low risk' mothers to have their babies.

4.70 Even in respect of 'low risk' mothers, it seems to me that NSW Health cannot offer maternity services at a particular hospital unless it can also offer timely access to the workforce and facilities necessary to provide an emergency caesarean section if the "low-risk" birth turns out not to be as low-risk as previously thought. Whilst there are a range of clinical views on the subject, access to an emergency caesarean section within 30 minutes travel time of identifying the need for one seems to be a safe guideline within which to work.

4.71 My recommendations are as follows:

Recommendation 8: *NSW health should address the following matters with respect to its maternity services:*

- (a) *Within 12 months, NSW Health consider and determine whether area health services be permitted to enter into "fee for service" contracts with midwives, including determining what arrangements with NSW Treasury are necessary in relation to the extension of current indemnity to cover such midwives;*
- (b) *NSW Health, through the area health services, identify which hospitals would be appropriate for the introduction of a caseload model of maternity care in addition to, or in lieu of full-time maternity services. Following the review, NSW Health is to plan for the introduction of that model of care, where viable on a clinical needs basis and subject to available funding;*
- (c) *In the interests of patient safety, NSW Health only offer birthing facilities for low risk mothers in hospitals which satisfy the following criteria:*
 - (i) *the hospital has an adequate number of health professionals qualified and trained to assist with the birth, such as midwives or VMOs with the necessary credentials; and*
 - (ii) *the hospital has, on-site, or else has the ability to transfer the mother within 30 minutes travel time to a hospital which has on-site, the workforce and facilities to perform an emergency caesarean section.*

¹ Australian Bureau of Statistics (ABS), *New South Wales in Focus: 2008 (Reissue)*, 17 June 2008, ABS, p. 4, <http://www.abs.gov.au> (9 September 2008).

² Letter from NSW Health to Special Commission of Inquiry, 10 October 2008, citing information from the NSW Health's Health Information Exchange.

-
- ³ Letter from NSW Health to Special Commission of Inquiry, 10 October 2008, citing information from the NSW Health's Health Information Exchange.
 - ⁴ Information provided during visits to Bellinger River District Hospital on 26 March 2008 and Mullumbimby Hospital on 29 April 2008.
 - ⁵ Information provided during visit to Mullumbimby Hospital on 29 April 2008.
 - ⁶ Information provided during visit to Mullumbimby Hospital on 29 April 2008.
 - ⁷ Letter from NSW Health to Special Commission of Inquiry, 10 October 2008. At Royal Prince Alfred Hospital there were 4,631 births in 2005 and 4,963 births in 2006. 5,184 births were reported at Royal Prince Alfred Hospital in 2007, although finalisation of 2007 figures is yet to be completed.
 - ⁸ Australian Nursing & Midwifery Council, *Code of Ethics for Midwives in Australia*, 2005, Australian Nursing & Midwifery Council, Dickson, ACT, p. 1.
 - ⁹ Section 3(1), *Nurses and Midwives Act 1991* (NSW).
 - ¹⁰ University of Technology Sydney (UTS), *UTS Handbook 2008*, 2007, UTS, Sydney, <http://www.handbook.uts.edu.au/nmh/index.html> (10 October 2008).
 - ¹¹ UTS, *UTS Handbook 2008*, 2007, UTS, Sydney, <http://www.handbook.uts.edu.au/nmh/index.html> (10 October 2008).
 - ¹² UTS, *UTS Handbook 2008*, 2007, UTS, Sydney, <http://www.handbook.uts.edu.au/nmh/index.html>, (10 October 2008).
 - ¹³ UTS, *UTS Handbook 2008*, 2007, UTS, Sydney, <http://www.handbook.uts.edu.au/nmh/index.html>, (10 October 2008).
 - ¹⁴ See: University of Newcastle, *Program Handbook 2008*, 2007, University of Newcastle, Newcastle, <http://www.newcastle.edu.au/program/archive/postgraduate/2008/10963.html> (6 November 2008); University of Western Sydney (UWS), *UWS Handbook 2008*, 2007, UWS, Sydney, <http://handbook.uws.edu.au/hbook/course.aspx?course=4505> (6 November 2008); UTS, *UTS Handbook 2008*, 2007, UTS, Sydney, <http://www.handbook.uts.edu.au/nmh/pg/c07070.html> (6 November 2008); and Charles Sturt University (CSU), *Online Course Handbook 2008*, 2007, CSU, <http://www.csu.edu.au/courses/postgraduate/midwifery> (6 November 2008).
 - ¹⁵ Letter from NSW Health to Special Commission of Inquiry, 10 October 2008; see also: University of Wollongong, *Course Handbook for 2008*, 2007, University of Wollongong, Wollongong, <http://www.uow.edu.au/handbook/yr2008/pg/hbs/H08006794.html> (6 November 2008).
 - ¹⁶ Jane Morley, Westmead hearing, 26 May 2008, transcript 3206.12-15.
 - ¹⁷ Jane Morley, Westmead hearing, 26 May 2008, transcript 3206.7-9.
 - ¹⁸ Jane Morley, Westmead hearing, 26 May 2008, transcript 3206.15-21.
 - ¹⁹ NSW Health, *Policy Directive: Continuing Education Allowances – Public Health System Nurses' and Midwives' (State) Award*, PD2007_86.
 - ²⁰ NSW Health, *Policy Directive: Midwives – NSW Health – Credentialling Framework*, PD2005_615.
 - ²¹ NSW Health, *Policy Directive: Midwives – NSW Health – Credentialling Framework*, PD2005_615.
 - ²² NSW Health, *Policy Directive: Midwives – NSW Health – Credentialling Framework*, PD2005_615.
 - ²³ NSW Health, *Policy Directive: Midwives – NSW Health – Credentialling Framework*, PD2005_615.
 - ²⁴ NSW Health, *Policy Directive: Midwives – NSW Health – Credentialling Framework*, PD2005_615.
 - ²⁵ NSW Health, *Policy Directive: Midwives – NSW Health – Credentialling Framework*, PD2005_615.
 - ²⁶ Australian Institute of Health and Welfare, *Nursing and Midwifery Labour Force 2005*, 18 January 2008, Australian Institute of Health and Welfare, p. 25, <http://www.aihw.gov.au/publications/index.cfm/title/10475> (13 October 2008).

-
- 27 Hannah Dahlen, Sydney Children's Hospital hearing, 19 May 2008, transcript 3016.45-47.
- 28 Confidential Wollongong hearing, 14 April 2008, transcript 39.37-47.
- 29 Confidential Wollongong hearing, 14 April 2008, transcript 39.47-40.7.
- 30 Margaret Watherston, Tweed Heads hearing, 29 April 2008, transcript 2376.39-42.
- 31 Confidential Royal Prince Alfred Hospital hearing, 20 May 2008, transcript 17.16-35.
- 32 Confidential Wollongong hearing, 14 April 2008, transcript 44.8-9.
- 33 Confidential Wollongong hearing, 14 April 2008, transcript 44.9-10.
- 34 Confidential Wollongong hearing, 14 April 2008, transcript 44.12-19.
- 35 Hannah Dahlen, Sydney Children's Hospital hearing, 19 May 2008, transcript 3017.1-6.
- 36 Hannah Dahlen, Sydney Children's Hospital hearing, 19 May 2008, transcript 3020.7-8.
- 37 Hannah Dahlen, Sydney Children's Hospital hearing, 19 May 2008, transcript 3015.35-37.
- 38 Margaret Watherston, Tweed Heads hearing, 29 April 2008, transcript 2377.01-2378.12, 2379.21-25.
- 39 Danette Watson, Wagga Wagga hearing, 22 April 2008, transcript 1953.35-45.
- 40 Submission of Debbie Mukhar, 27 March 2008, SUBM.012.0362 at 365..
- 41 Submission of Justine Caines, SUBM.037.0005 at 12, citing New Zealand Ministry of Health, *Report on Maternity 1999, 2001*, New Zealand Ministry of Health, Wellington, <http://www.moh.govt.nz/moh.nsf/pagesmh/1045> (5 November 2008). The author of this submission told me that in 1999, more than 73% of all Maori women chose midwifery-only care.
- 42 Hannah Dahlen, Sydney Children's Hospital hearing, 19 May 2008, transcript 3028.17-23.
- 43 Letter from NSW Health to Special Commission of Inquiry, 10 October 2008.
- 44 Mark Metherell, "Baby boom signals greater role for midwives", Sydney Morning Herald, 10 September 2008.
- 45 Department of Health and Ageing (Commonwealth), *Improving Maternity Services in Australia: A Discussion Paper from the Australian Government*, 2008, Commonwealth of Australia, Barton, ACT.
- 46 Letter from NSW Health to Special Commission of Inquiry, 10 October 2008.
- 47 Danette Watson, Wagga Wagga hearing, 22 April 2008, transcript 1953.38-41.
- 48 NSW Health briefing, 13 March 2008, transcript 20.42-44.
- 49 Maree Heath, Wagga Wagga hearing, 22 April 2008, transcript 1991.46-47.
- 50 Maree Heath, Wagga Wagga hearing, 22 April 2008, transcript 1992.1-3.
- 51 Maree Heath, Wagga Wagga hearing, 22 April 2008, transcript 1991.3-6.
- 52 Maree Heath, Wagga Wagga hearing, 22 April 2008, transcript 1991.6-8; see also the submission of the Australian Society of Independent Midwives, 2 April 2008, SUBM.049.0109 at 111.
- 53 Letter from NSW Health to Special Commission of Inquiry, 10 October 2008.
- 54 Letter from NSW Health to Special Commission of Inquiry, 10 October 2008.
- 55 Letter from NSW Health to Special Commission of Inquiry, 10 October 2008.
- 56 NSW Health, *The NSW Framework for Maternity Services*, 2000, NSW Health, North Sydney.
- 57 NSW Health, *The NSW Framework for Maternity Services*, 2000, NSW Health, North Sydney, p. 9.
- 58 NSW Health, *The NSW Framework for Maternity Services*, 2000, NSW Health, North Sydney, p. 20.
- 59 NSW Health, *The NSW Framework for Maternity Services*, 2000, NSW Health, North Sydney, Foreword.
- 60 NSW Health, *Models of Maternity Service Provision Across NSW: Progressing Implementation of the NSW Framework for Maternity Services*, 2003, NSW Health, North Sydney,.

-
- ⁶¹ NSW Health, *Policy Directive: Maternity – Public Homebirth Services*, PD2006_45.
- ⁶² Australian Health Ministers' Advisory Council, *Primary Maternity Services in Australia – A Framework for Implementation*, 2008, Australian Health Ministers' Advisory Council, http://www.ahmac.gov.au/cms_documents/Primary%20Maternity%20Services%20in%20Australia.pdf (6 November 2008).
- ⁶³ NSW Health, *Models of Maternity Service Provision Across NSW: Progressing Implementation of the NSW Framework for Maternity Services*, 2003, NSW Health, North Sydney, p. 5.
- ⁶⁴ Submission of Homebirth Access Sydney, 25 April 2008, SUBM.054.0004 at 8.
- ⁶⁵ Submission of Justine Caines, SUBM.037.0005 at 6.
- ⁶⁶ Justine Caines, Tamworth hearing, 25 March 2008, transcript 782.20-21.
- ⁶⁷ Flitcroft K and Boxall A, Australian Health Policy Institute, *Maternity Services Options: A Review of the Evidence on Alternative Models of Care*, November 2006, Australian Health Policy Institute, p. 8.
- ⁶⁸ Flitcroft K and Boxall A, Australian Health Policy Institute, *Maternity Services Options: A Review of the Evidence on Alternative Models of Care*, November 2006, Australian Health Policy Institute, p. 8.
- ⁶⁹ Flitcroft K and Boxall A, Australian Health Policy Institute, *Maternity Services Options: A Review of the Evidence on Alternative Models of Care*, November 2006, Australian Health Policy Institute, p. 8.
- ⁷⁰ Flitcroft K and Boxall A, Australian Health Policy Institute, *Maternity Services Options: A Review of the Evidence on Alternative Models of Care*, November 2006, Australian Health Policy Institute, p. 8.
- ⁷¹ Flitcroft K and Boxall A, Australian Health Policy Institute, *Maternity Services Options: A Review of the Evidence on Alternative Models of Care*, November 2006, Australian Health Policy Institute, p. 8.
- ⁷² Flitcroft K and Boxall A, Australian Health Policy Institute, *Maternity Services Options: A Review of the Evidence on Alternative Models of Care*, November 2006, Australian Health Policy Institute, p. 9.
- ⁷³ John Smoleniec, Liverpool hearing, 17 April 2008, transcript 1879.33-34.
- ⁷⁴ John Smoleniec, Liverpool hearing, 17 April 2008, transcript 1879.34-36.
- ⁷⁵ Information provided during visit to Camden Hospital on 16 April 2008.
- ⁷⁶ Information provided during visit to Camden Hospital on 16 April 2008.
- ⁷⁷ Information provided during visit to Camden Hospital on 16 April 2008.
- ⁷⁸ Information provided during visit to Camden Hospital on 16 April 2008.
- ⁷⁹ Tracy S and Hartz D, Northern Sydney Central Coast Area Health Service, *Final Report - Quality Review of Ryde Midwifery Group Practice: September 2004 to October 2005*, 2006, Northern Sydney Central Coast Area Health Service, p. 5.
- ⁸⁰ Tracy S and Hartz D, Northern Sydney Central Coast Area Health Service, *Final Report - Quality Review of Ryde Midwifery Group Practice: September 2004 to October 2005*, 2006, Northern Sydney Central Coast Area Health Service, p. 5.
- ⁸¹ Tracy S and Hartz D, Northern Sydney Central Coast Area Health Service, *Final Report - Quality Review of Ryde Midwifery Group Practice: September 2004 to October 2005*, 2006, Northern Sydney Central Coast Area Health Service, p. 8.
- ⁸² Baghurst P et al, Children Youth and Women's Health Service – Women's and Children's Hospital Adelaide, *Midwifery Group Practice: An Evaluation of Clinical Effectiveness, Quality and Sustainability*, December 2005, Women's and Children's Hospital, Adelaide, p. 10.
- ⁸³ Baghurst P et al, Children Youth and Women's Health Service – Women's and Children's Hospital Adelaide, *Midwifery Group Practice: An Evaluation of Clinical Effectiveness, Quality and Sustainability*, December 2005, Women's and Children's Hospital, Adelaide, p. 10.
- ⁸⁴ Baghurst P et al, Children Youth and Women's Health Service – Women's and Children's Hospital Adelaide, *Midwifery Group Practice: An Evaluation of Clinical Effectiveness, Quality and Sustainability*, December 2005, Women's and Children's Hospital, Adelaide, p. 10.

-
- 85 Baghurst P et al, Children Youth and Women's Health Service – Women's and Children's Hospital Adelaide, *Midwifery Group Practice: An Evaluation of Clinical Effectiveness, Quality and Sustainability*, December 2005, Women's and Children's Hospital, Adelaide, p. 12.
- 86 Jane Morley, Westmead hearing, 26 May 2008, transcript 3204.31-33.
- 87 Jane Morley, Westmead hearing, 26 May 2008, transcript 3204.39-40.
- 88 Jane Morley, Westmead hearing, 26 May 2008, transcript 3205.5-17.
- 89 Janet Long, Nepean Hospital hearing, 8 April 2008, transcript 1350.27-35.
- 90 Submission of Justine Caines, SUBM.037.0005 at 11.
- 91 Professor Sally Tracey, Sydney Children's Hospital hearing, 19 May 2008, transcript 3026.9-17.
- 92 John Smoleniec, Liverpool hearing, 17 April 2008, transcript 1879.41-42.
- 93 John Smoleniec, Liverpool hearing, 17 April 2008, transcript 1879.43-44.
- 94 John Smoleniec, Liverpool hearing, 17 April 2008, transcript 1879.47-1880.3.
- 95 John Smoleniec, Liverpool hearing, 17 April 2008, transcript 1880.3.
- 96 Confidential Armidale hearing, 26 March 2008, transcript 11.10-14.
- 97 Claire Simmonds, Coffs Harbour hearing, 27 March 2008, transcript 965.33-41.
- 98 Claire Simmonds, Coffs Harbour hearing, 27 March 2008, transcript 965.43-966.6.
- 99 Information provided during visit to Mullumbimby Hospital on 29 April 2008.
- 100 Information provided during visit to Mullumbimby Hospital on 29 April 2008.
- 101 Information provided during visit to Royal Prince Alfred Hospital's Women's & Children's Unit on 20 May 2008.
- 102 Sally Brown, Nepean Hospital hearing, 8 April 2008, transcript 1398.9-17.
- 103 NSW Health, *Policy Directive: Maternity – Public Homebirth Services*, PD2006_045.
- 104 NSW Health, *Policy Directive: Maternity – Public Homebirth Services*, PD2006_045.
- 105 NSW Health, *Policy Directive: Maternity – Public Homebirth Services*, PD2006_045.
- 106 NSW Health, *Policy Directive: Maternity – Public Homebirth Services*, PD2006_045.
- 107 NSW Health, *Policy Directive: Maternity – Public Homebirth Services*, PD2006_045.
- 108 Letter from NSW Health to Special Commission of Inquiry, 10 October 2008.
- 109 Letter from NSW Health to Special Commission of Inquiry, 10 October 2008.
- 110 Letter from NSW Health to Special Commission of Inquiry, 10 October 2008.
- 111 Letter from NSW Health to Special Commission of Inquiry, 10 October 2008. I understand that in addition to the 2 Tamworth births, one woman was transferred to hospital.
- 112 Letter from NSW Health to Special Commission of Inquiry, 10 October 2008.
- 113 Letter from NSW Health to Special Commission of Inquiry, 10 October 2008.
- 114 Letter from NSW Health to Special Commission of Inquiry, 10 October 2008.
- 115 Letter from NSW Health to Special Commission of Inquiry, 10 October 2008.
- 116 Hannah Dahlen, Sydney Children's Hospital hearing, 19 May 2008, transcript 3019.10-11.
- 117 Homer C and Caplice S, *Evaluation of the Publicly-Funded Home Birth Program in South East Sydney Illawarra Area Health Service*, September 2007, SUBM.054.0037 at 65.
- 118 Margaret Watherston, Tweed Heads hearing, 29 April 2008, transcript 2383.29-38.
- 119 Angela Pridham, Wollongong hearing, 14 April 2008, transcript 1714.39-42.
- 120 Angela Pridham, Wollongong hearing, 14 April 2008, transcript 1715.16-19.
- 121 Angela Pridham, Wollongong hearing, 14 April 2008, transcript 1715.19-20.
- 122 Angela Pridham, Wollongong hearing, 14 April 2008, transcript 1715.21-23.
- 123 Submission of Justine Caines, SUBM.037.0005 at 7.

- ¹²⁴ Margaret Watherston, Tweed Heads hearing, 29 April 2008, transcript 2376.30-37. Verified by information obtained from NSW Health: Letter from NSW Health to Special Commission of Inquiry, 24 October 2008.
- ¹²⁵ Tracy S et al, "Does Size Matter? A Population-Based Study of Birth in Lower Volume Maternity Hospitals for Low-Risk Women" (2006) 10 *British Journal of Obstetrics and Gynaecology* 86, p. 90.
- ¹²⁶ Tracy S et al, "Does Size Matter? A Population-Based Study of Birth in Lower Volume Maternity Hospitals for Low-Risk Women" (2006) 10 *British Journal of Obstetrics and Gynaecology* 86, p. 91.
- ¹²⁷ John Pardey, Nepean Hospital hearing, 8 April 2008, transcript 1423.40-42.
- ¹²⁸ John Pardey, Nepean Hospital hearing, 8 April 2008, transcript 1423.43-44.
- ¹²⁹ See the evidence of John Pardey, Nepean Hospital hearing, 8 April 2008, transcript 1421.42-1423.38.
- ¹³⁰ John Pardey, Nepean Hospital hearing, 8 April 2008, transcript 1423.46-1424.1.
- ¹³¹ John Pardey, Nepean Hospital hearing, 8 April 2008, transcript 1425.5-9.
- ¹³² Flitcroft K and Boxhall A, Australian Health Policy Institute, *Maternity Services Options: A Review of the Evidence on Alternative Models of Care*, November 2006, Australian Health Policy Institute, p. 1.

5 Babies, children & young people

Paediatrics	98
Child and adolescent mental health	99
Prevalence of mental illness in children and adolescents	99
Drug and alcohol abuse in children and adolescents	101
Increasing demand	101
Under-funding	102
Lack of inpatient beds	102
Treatment at adult facilities	102
Recent initiatives	103
Conclusion	103
Referrals to specialist children's hospitals	104
Problems caused by transferring children to specialist hospitals unnecessarily	105
The need for guidelines	107
Transfer of care of complex paediatric patients to other hospitals ...	108
Rare conditions	108
Unusual treatments	109
Local staffing levels	109
Assistance from the specialist hospital	110
Obstacles from area health services	110
Transition of complex paediatric patients to adult hospitals	111
Children and Young Peoples' Health Authority ("NSW Kids")	113
Mental health	116
Community health	116
Rural areas	117
NSW Paediatric Hospital	117
Queensland	118
Ireland	119
The way forward	119

- 5.1 In this chapter, I will examine the 5 main issues that arose in respect of paediatric patients in NSW, being:
- (a) deficiencies in the treatment of child and adolescent mental health;
 - (b) the referral of children to specialist children's hospitals;
 - (c) the transfer of complex paediatric patients to non-specialist hospitals;
 - (d) the transition of complex paediatric patients to adult hospitals; and
 - (e) the overall co-ordination of paediatric services across NSW.

Paediatrics

- 5.2 Paediatrics is the specialisation in the medical or surgical care of children. Generally, the term "child" refers to a patient aged less than 16 years,¹ although it may include children who are a little older. It does not include "neonates" who are newborn children, generally in the first 4 weeks of life, unless they need to remain in hospital for surgery or specialised treatment for complex conditions. Such surgery and treatment would ordinarily be of a kind which necessitates admission to a specialist hospital for children.
- 5.3 Babies and children have a vast range of needs for hospital care, from high temperatures to complex heart surgery. These types of care are generally divided into the following levels:
- (a) **Primary level services**, which includes treatment for such conditions as broken bones, urinary tract infections, cellulitis, bronchitis and asthma. Primary care is provided in most hospitals, together with approximately 100 community health centres and the hundreds of GP surgeries throughout NSW.
 - (b) **Secondary level services** provide treatment for more serious conditions. These services are generally only available in hospitals and may require overnight stays. About 30 hospitals around NSW provide paediatric services at a secondary level.
 - (c) **Tertiary level services**, which are the top level of specialist services, including paediatric intensive care units and paediatric medical and surgical sub-specialities. The top levels of pathology, pharmacy, diagnostic imaging and nuclear medicine support these services.² Tertiary level services are provided in NSW by the 3 specialist hospitals set out in the table below.

Table 5.1 Tertiary level specialist children's hospitals in NSW

	Beds	Incidences of treatment each year	Area health service
Children's Hospital at Westmead	339 ³	27,625 ⁴	Children's Hospital at Westmead
Sydney Children's Hospital, Randwick	141 ⁵	14,555 ⁶	South Eastern Sydney / Illawarra
John Hunter Children's Hospital, Newcastle	112 ⁷	7,560 ⁸	Hunter New England

- 5.4 All 3 specialist children’s hospitals are located close to major adult hospitals: Sydney Children’s Hospital is attached to Prince of Wales Hospital and Sydney Women’s Hospital; John Hunter Children’s Hospital is part of the John Hunter Hospital Campus; and the Children’s Hospital, Westmead is next door to the Westmead Hospital.
- 5.5 There are inconsistent management structures for the 3 specialist children’s hospitals – 2 form part of a much larger area health service whilst, curiously, the Children’s Hospital at Westmead comprises its own area health service.

Child and adolescent mental health

- 5.6 I want to address the treatment of mental illness in our children and young people at the outset, as I regard it as an area which is grossly under-resourced.

Prevalence of mental illness in children and adolescents

- 5.7 It has been some time since a comprehensive national survey was undertaken in respect of the incidence of mental illness in children and adolescents. According to *The National Survey of Mental Health and Wellbeing* (1997) conducted by the Australian Bureau of Statistics, the incidence of mental illness amongst children aged from 0-17 is as set out in the table below. Given that, as at July 2007, the NSW population in the 0-17 age group was 1,613,946,⁹ I have also estimated the number of young people suffering from a mental illness in the table below.

Table 5.2 Incident of mental illness in 0-17 years of age¹⁰

Severity	Description	Incidence	Estimated sufferers in NSW
Mild	Mild high prevalence disorders such as anxiety and depression	7.9%	127,501
Moderate	Moderate high prevalence disorders such as anxiety and depression.	5.4%	87,153
Severe	Severe mental illnesses include, for example, severe forms of schizophrenia and bipolar disorders, severe depression and anxiety.	2%	32,278
	Total	15.4%	248,548

- 5.8 According to the *Child and Adolescent Component of the National Survey of Mental Health and Wellbeing* (2000), 14% of children and adolescents in Australia have mental health problems, as set out in more detail in the table below.¹¹

Table 5.3 Prevalence of mental health problems in 4-12 years of age¹²

	Total problems (%)	Total problems - Population estimate (estimated number of children and adolescents with a mental health problem in Australia)
All children	14.1	521,886
males 4-12 year old	15.0	181,749
males 13-17 year old	13.4	90,678
females 4-12 year old	14.4	166,817
females 13-17 year old	12.8	82,221

- 5.9 Of particular concern, the *Child and Adolescent Component of the National Survey of Mental Health and Wellbeing* (2000) found that there was limited help available for these patients:¹³
- Only one out of every 4 young people with mental health problems received professional help. Family doctors, school counsellors and paediatricians most frequently provided assistance, rather than specialised mental health clinicians.
 - Even among young people with the most severe mental health problems, only 50% received professional help. Again, this help mostly came from health and education professionals who may have only limited training in the assessment and management of mental health problems.
- 5.10 According to a survey by the Australian Bureau of Statistics in 2004-05, 7% of children aged under 15 years were reported to have some form of mental or behavioural problem as a long-term health condition, “with rates rising from very low levels among children aged under 5 years to 10% of children aged 10-14 years.”¹⁴
- 5.11 People in younger age groups experience higher rates of mental illness than older people. According to *The National Survey of Mental Health and Wellbeing* (2007), more than a quarter (26%) of people aged 16-24 years and a similar proportion (25%) of people aged 25-34 years had a mental illness compared with 5.9% of those aged 75-85 years old.

Table 5.4 12-month mental disorders by age¹⁵

2. 12-MONTH MENTAL DISORDERS (a), by Age (b)

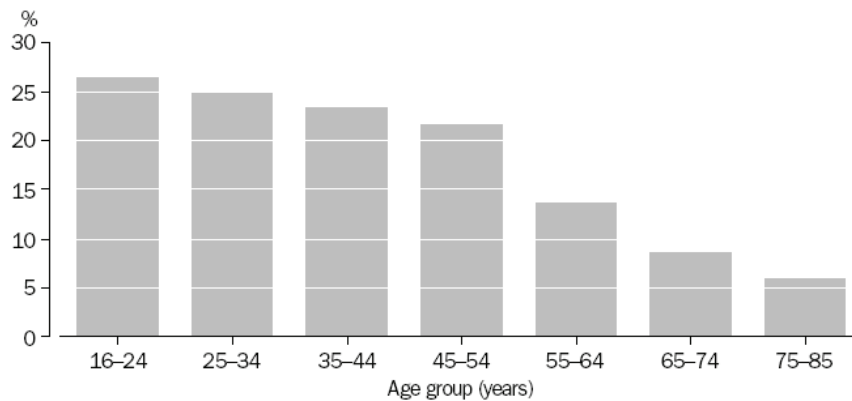

(a) Persons who met criteria for diagnosis of a lifetime mental disorder (with hierarchy) and had symptoms in the 12 months prior to interview. A person may have had more than one mental disorder.
 (b) Persons who had a 12-month mental disorder as a proportion of all persons in that same age group.

Drug and alcohol abuse in children and adolescents

- 5.12 According to *The National Survey of Mental Health and Wellbeing (2007)*, people in younger age groups also had higher prevalence of Substance Use disorders, at 13%, than older age groups.

Table 5.5 12-month mental disorders by major disorder group and age¹⁶

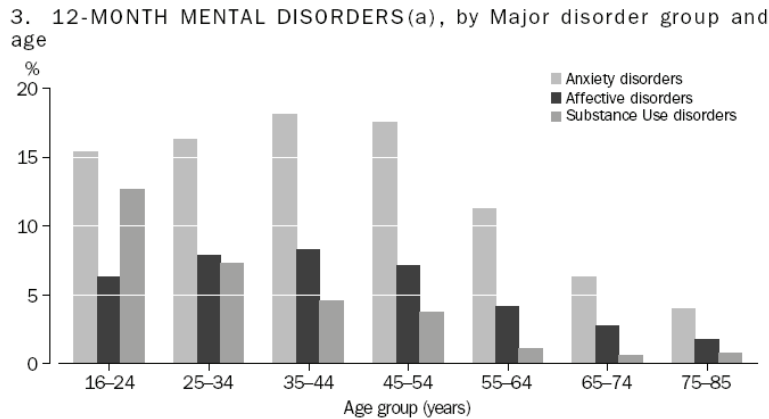

- 5.13 In 2005-06, there were:
- 8,013 hospitalisations among young people (15-24 year olds)¹⁷ for mental and behavioural disorders due to drug and alcohol use (almost 2% of all hospitalisations among young people);¹⁸
 - 195 hospitalisations for accidental overdose of narcotics and hallucinogens, and
 - 120 for accidental poisoning by alcohol.¹⁹
- 5.14 Of particular concern is increasing alcohol abuse amongst young people. A recent report issued by NSW Health showed a 55% increase between 2000 and 2007 in Emergency Department visits for alcohol-related problems in 10-17 year olds. On average, 3 children aged 10-17 present to Emergency Departments each day with alcohol problems. The report was based on data collated by 44 Emergency Departments across NSW, which covered two-thirds of the state's population.²⁰

Increasing demand

- 5.15 The evidence I heard indicated to me that there is increasing demand for child and adolescent mental health services in NSW.
- Children's Hospital at Westmead alone has had a 300% increase in mental health presentations to the Emergency Department over 3 years.²¹
 - Dr David Dossetor, Area Director of Mental Health at the Children's Hospital at Westmead, told me that over the last 10 years, the mental health department has been the fastest growing department in the hospital.²²
- 5.16 Patients are also getting younger. In the past, I was told, the vast majority of patients were teenagers, but I am told they are now as young as 6 years old.²³

Under-funding

- 5.17 Dr David Dossetor told me that child and adolescent mental health in NSW is under-resourced by international standards. Staffing levels are only 35% of the planned appropriate level workforce predicted by the NSW Health Mental Health & Clinical Care and Prevention Service Planning Model and by the NSW Health Draft Child and Adolescent Mental Health Services Strategic Plan.²⁴
- 5.18 I was told that each of the area health services with their direct funding programs should be spending 15% of their mental health budget on child and adolescent mental health. However, at best child and adolescent mental health gets 4%.²⁵ I have discussed the direct funding programs for mental health services in Chapter 25.

Lack of inpatient beds

- 5.19 The number of inpatient beds for children and adolescents with mental illness in NSW is very limited: there is a total of 47 acute beds and 56 non-acute beds across the state.²⁶
- I was told that there are regularly no beds available at Hall Ward, an inpatient mental health unit at the Children's Hospital at Westmead.²⁷ There are usually 3 patients waiting for admission to this unit.²⁸ (In addition, I was told that Hall Ward is a third of the size that is required by the Australasian mental health building guidelines.²⁹)
 - The Redbank unit, which is on the campus at the Children's Hospital at Westmead, has 9 acute beds for patients between 13 and 17 years-old. I was told that there is demand for a unit housing easily twice that number, which would be best placed further west in the Mt Druitt area.³⁰
 - At Rivendell Adolescent Unit (Thomas Walker Hospital), which is a 20 bed non-acute inpatient facility, there is a 6 week waiting list for assessment.³¹
 - In the area surrounding Wagga Wagga, there are no child and adolescent mental health beds at all, so patients between the ages of 12 and 18 must be scheduled into an adult mental health unit and managed one-on-one, causing significant strain on staffing.³²

Treatment at adult facilities

- 5.20 I heard disturbing evidence that, due to the lack of inpatient beds for child and adolescent patients, such patients may be treated in an adult facility.
- The Director of Clinical Mental Health Services and a senior Consultant Psychiatrist at Royal North Shore Hospital expressed concern to me about 13 or 14 year olds being admitted to the adult psychiatric ward because there is no designated adolescent facility.³³
 - The Australian Confederation of Paediatric and Child Health Nurses (NSW Branch) have also expressed concern that there are insufficient gazetted paediatric mental health beds in NSW, and virtually no access to community based specialist psychiatric care for children.³⁴
 - I was told at the Northern Sector Community Mental Health Service at Wollongong that there is no crisis intervention funding beyond the age of 14. Young people who are 14 and above must go to an adult setting.³⁵

- When teenage patients aged 14 and above are admitted to the Chisholm Ross Centre in Goulburn, they are accommodated in a bedroom with *en suite* bathroom facilities which is at the end of the adult wing. A special nurse is employed to take care of any adolescent patient who needs acute care in that facility. There are no separate recreational facilities.³⁶
- 5.21 In my view, adult psychiatric facilities are a totally inappropriate place to admit an adolescent patient who requires acute treatment.

Recent initiatives

- 5.22 NSW Health has recognised in its recent *NSW Community Mental Health Strategy 2007-2012* that there is no consistent approach to child and adolescent mental health programs across all of NSW.³⁷ Services have instead developed *ad hoc* to address local needs.
- 5.23 In response to this, NSW Health has developed MH-Kids, a state-wide unit of the new Mental Health and Drug and Alcohol Office that is responsible for developing and implementing consistent Child and Adolescent Mental Health Services policies. This will occur in conjunction with the *Child and Adolescent Mental Health Services Plan: Building a Secure Base for the Future* which guides Child and Adolescent Mental Health Services planning over the next 10 years. This plan applies to children from 0 to 17 years of age.³⁸
- 5.24 Alongside this is a Youth Mental Health Services Model for people aged 14 to 24 years for which all area health services are receiving their share of \$6.8 million in annual recurrent funding from 2007-08. It was piloted in the Northern Sydney / Central Coast Area Health Service (called Y-Central) in 2006-07 and will be progressively implemented in other area health services. NSW Health tells me that Y-Central was officially launched on 9 October 2008, and that all area health services have commenced progressive implementation of their youth service models. I am told a build-up of recruitment of more than 60 new clinical positions has begun. The youth service models are planned to be fully operational by June 2009.³⁹

Conclusion

- 5.25 It is essential that the mental health and wellbeing of children and adolescents in NSW is prioritised by NSW Health, and that adequate, safe and nurturing, acute and sub-acute facilities are provided which are separate from adult facilities.
- 5.26 Child and adolescent ambulatory-care services must also receive greater funding and be co-ordinated so that they are able to be accessed by young people.
- 5.27 I was told by Professor Kay Wilhelm, Director, Clinical Consultant Liaison Psychiatry Services in South Eastern Sydney Illawarra Area Health Service, that the present state of child and adolescent mental health in NSW suffers from the following problems:⁴⁰
- inconsistent and poorly coordinated mental health services;
 - poor integration with drug & alcohol services;
 - incomplete implementation of comprehensive Child & Adolescent Mental Health Services across NSW; and
 - the use of several different models of care even in one area health service.

Clearly, we need to do better than this.

- 5.28 I have discussed elsewhere in this chapter the establishment of an area health authority for children and young people. It should have responsibility for mental health as well, with a view to resolving the deficiencies identified above.

Referrals to specialist children's hospitals

- 5.29 Many clinicians at specialist paediatric hospitals complained that other hospitals referred patients who did not, in truth, require specialist tertiary care. The reasons for transferring such patients appeared to be to alleviate workloads, to deal with a lack of beds, operating theatre time or funding, and a lack of confidence in treating children.
- (a) Witnesses at Children's Hospital at Westmead said that other hospitals have realised that they can save money by sending children to specialist children's hospitals, and are not censored for doing so, even though the services which these children require could be provided by local hospitals.⁴¹
- (b) Dr McCaskill, Medical Head of the Emergency Department at Children's Hospital at Westmead, told me that there has been a marked increase in Emergency Department presentations at the hospital in the last 3 years. Last year alone, there was a 20% increase from 40,000 to 48,500 patients.⁴² This included referrals from GPs for conditions that weren't serious. These patients could have just as easily been referred to another non-specialist hospital for treatment.⁴³ Dr McCaskill also observed that if non-specialist hospitals have pressure on their inpatient beds, then they send the children to the specialist hospital. When the other hospitals have a significant load of adult patients to treat, the specialist children's hospitals are seen as a way of getting children treated. Often these children have minor injuries and do not require specialist treatment.⁴⁴ This also happens with after-hours emergency surgery, even when the local hospital has paediatric surgery during business hours.⁴⁵ The result is a greater burden on specialist staff after hours, in addition to their other workload.⁴⁶
- (c) At the Sydney Children's Hospital, I was told that they receive a large proportion of patients who do not require specialist paediatric care, but have been sent there to relieve the pressure from the local adult hospital. A senior doctor complained that there was no unifying model which specified exactly when treatment should be provided at specialist or non-specialist hospitals. Consequently, patients were travelling long distances to have procedures done at Sydney Children's Hospital that could have been provided locally.

"A 15-year-old adolescent boy in Mona Vale Hospital, for example, may be assessed there with abdominal pain and thought to have appendicitis and would be transferred here and he would have his operation performed here. If he was 6 or 12 months older that surgery would be performed locally."⁴⁷

Whilst the sending hospital can save money by not having to roster paediatric staff, there is no flow-on of funds to the specialist children's hospitals for doing the extra work.⁴⁸

- 5.30 The problem also exists in reverse, when specialist children's hospitals try and transfer babies and children back to the referring hospitals after their period of specialist treatment is completed. Receiving hospitals may not be willing to accept the transfer due to a lack of staff to care for a recovering but not completely well baby or child.
- (a) I was told that this is a problem when staff are trying to transfer babies from the neonatal unit to local hospitals and they are not accepted due to staffing

problems at the local hospital,⁴⁹ or the absence of staff with the required expertise.⁵⁰

- (b) I heard that it is hard after hours to discharge a patient back to the peripheral hospital due to the lack of paediatric ability after hours. This includes major teaching hospitals in south-western Sydney which may have paediatric beds, but do not really have after-hours paediatric services.⁵¹

Newborn & Paediatric Emergency Transport Service

- 5.31 The air ambulance used for babies and children, (Newborn & Paediatric Emergency Transport Service or “NETS”), referred to a similar difficulty. NETS provides a mobile emergency service for babies and children across NSW and the ACT who need intensive care treatment. The range of services that NETS provides includes:
- transporting intensive care services to sick children;
 - transporting children who are receiving intensive care; and
 - operating a 24 hour clinical hotline called ‘NETS line’.⁵²
- 5.32 While guidelines have been developed to assist hospitals to determine the appropriate response to emergency situations and a one-page poster has been designed for display in labour wards and nurseries,⁵³ I was told that NETS needs more resources to educate referring hospitals as to which children need to be transferred to a children’s hospital.⁵⁴
- 5.33 NETS is a valuable resource and one that should not be wasted with unnecessary transporting of children who can receive care in their local hospital. Quite apart from the waste of a valuable resource, the disruption and cost to families of unnecessarily moving a child from the local facility to Sydney or Newcastle for treatment should be avoided wherever possible.
- 5.34 According to Professor Alan Isles, Acting CEO, Queensland Child Health Services District, Brisbane, Queensland, a somewhat simpler approach is taken by the Director of Paediatrics at Mackay Hospital in Queensland, who applies a simple test:
- “If the consultation or service can be obtained by telehealth, then there is no travel.”⁵⁵

I have discussed the general question of telehealth in Chapter 6.

Problems caused by transferring children to specialist hospitals unnecessarily

- 5.35 Transferring babies and children to specialist children’s hospitals when they don’t require specialist treatment causes many problems at the specialist children’s hospitals.

Overloaded specialist children’s hospitals

- 5.36 The specialist children’s hospitals become overloaded, and this delays the delivery of tertiary care to the babies and children who really need it. Surgery and other types of treatments are consequently delayed.
- (a) Doctors at Children’s Hospital at Westmead told me that, as a result of non-tertiary patients being sent unnecessarily to the tertiary hospital, other patients may be waiting up to 2 days for semi-urgent procedures of a kind which **do** have to be done at the specialist tertiary hospital. Tertiary patients have to wait for treatments such as tumour biopsies with central lines, or magnetic resonance imaging (MRI scans).⁵⁶ I was informed that the waiting lists for MRI scans at both Children’s Hospital at Westmead and Sydney Children’s Hospital has been as

long as 2 months if the child is old enough to stay still, and up to 6 months if the child requires an anaesthetic.

"An 'urgent' MRI scan can be done within days but this involves pleading with and not uncommonly screaming at, overworked radiology and anaesthetic colleagues to try to get them to add another child into lists that are already overflowing."⁵⁷

- (b) Dr McCaskill, of Children's Hospital at Westmead, told me that specialist children's hospitals aren't resourced to be able to take the extra patients from local hospitals.⁵⁸ Ironically, the resulting delays in the surgical lists at Children's Hospital at Westmead may mean that it would have been quicker for the child to be treated at their local hospital.⁵⁹
- (c) A senior doctor at Sydney Children's hospital pointed out that the volume of less complex cases competes with tertiary cases for beds, radiology, other diagnostic service and surgeons after hours.⁶⁰

Impact on research and teaching

- 5.37 The increase in workload impacts on those at specialist children's hospitals who engage in teaching, consultation, outreach work and research.⁶¹ These specialist hospitals are virtually the only place in which to engage systematically in specialised training and research in paediatrics.⁶²

Funding pressures

- 5.38 Funding pressures are generated at the specialist children's hospitals by the increasing popularity of the specialist children's hospitals and increasing costs in providing the service. As I was told at Sydney Children's Hospital,

"If we were in a business, that would be a wonderful model to have. Unfortunately, we don't have that because more business just means more work with the same amount of money."⁶³

- 5.39 I was told at Sydney Children's Hospital that the adult hospitals are moving paediatric cases quickly to children's hospitals because they are losing confidence in treating children. However, funds don't flow with the patient. As a result, Sydney Children's Hospital has performed 3 times as many appendectomies over the last 3 years than previously with no increase in funding.⁶⁴
- 5.40 The increased demand is also felt at the Children's Hospital at Westmead.

"demand for services exceeds the ability of the hospital to provide them within the current resource constraints"⁶⁵
- 5.41 Each of the 3 specialist children's hospitals obtain their funding somewhat differently.
 - (a) As part of larger area health services, Sydney Children's Hospital and John Hunter Children's Hospital receive funding *via* the resource distribution formula, which assists in determining the appropriate allocation of funds, according to the estimated needs of the population. I have explained this further in Chapter 25.
 - (b) At a stand-alone area health service, the funding for the Children's Hospital at Westmead is based on historical demand. I was told that this was poorly adjusted to take into account current activity and the severity of patients' needs.⁶⁶

- 5.42 I received conflicting submissions as to whether episode funding will alleviate this problem.
- The treatment of children is often more time-consuming and requires higher staffing levels than treatment for adults. For example, the nurse to patient ratio for adults is in a post anaesthesia recovery area is 1:2 or 1:3 and for children it is 1:1 until they meet discharge criteria.⁶⁷ It takes 2 staff members to put a drip into a child, one to carry out the procedure and the other to hold the child still.⁶⁸ As such, the cost of treating a child is greater than for an adult. Concern was expressed that episode funding may not provide for the full value of treating children.

"A cost per case is not determined on a paediatric cost and our costs are benchmarked against other principal referral hospitals based on an average adult cost."⁶⁹
 - Another concern is that the AR-DRG (Australian Refined – Diagnosis Related Groups) that forms the basis of episode funding does not include all of the complications and co-morbidities that are found in paediatric cases. It follows that if paediatric hospitals were to be paid for each patient episode, without all of the complications allowed for, then the paediatric hospital would not be adequately compensated for treating the child.

" 'Pure' case-mix funding of specialist paediatric hospitals would have a major impact on specialist paediatric hospitals' financial viability."

"Childhood complications and co-morbidities codes [are] not taken into account by the AR-DRG system."⁷⁰
- 5.43 To deal with this concern, which I regard as legitimate, the AR-DRG needs to be reviewed and possibly expanded to include a greater range of conditions that are particular to paediatric treatments.

The need for guidelines

- 5.44 There is no clearly defined dividing line between secondary and tertiary care and consequently what services should be treated in a specialist children's hospital. This results in indecision and uncertainty about when a child should be receiving care at a specialist children's hospital, and when they can be treated locally.
- 5.45 NSW Health has developed guidelines for 12 common child related illnesses to assist in identifying when patients should be transferred to specialist paediatric centres.⁷¹ Whilst these provide some assistance, the guidelines are only for a select number of conditions, such as croup or head injury. The guidelines do not contain any general information on how to assess the appropriateness of transferring the patient to a specialist children's hospital. Absent any restriction or guidance on when to transfer patients, specialist children's hospitals are at the mercy of the judgment, whether good or not, of the staff at other hospitals.
- 5.46 There is no policy that instructs when children should be transferred to, or from a specialist paediatric hospital.

- 5.47 Staff at John Hunter Hospital have made some progress in addressing this problem, as described below.

An expert group from the Children and Young People and Families Clinical Network based at John Hunter Children's Hospital have developed a series of policies for local generalists to assist them in identifying what conditions ought be treated in the local facility. They have also developed guidelines for security of children in hospitals and the appropriate and timely escalation of care of children from one facility to another.⁷² They have worked to ensure that each facility has a minimum standard of equipment that may be required for treating children, for example, a Neopuff (resuscitation equipment). The staff in the local hospitals are also made aware of NSW Health's 12 clinical guidelines for the 10 most common presentations of children to the Emergency Department and are encouraged to follow these care pathways.⁷³

- 5.48 It was suggested to me that there needs to be a clearer delineation between the different types of services offered at each level of hospital and how services at each level can be accessed.⁷⁴ I agree.

Transfer of care of complex paediatric patients to other hospitals

- 5.49 A similar problem, but of greater complexity, is when a baby or child requiring ongoing high levels of complex care is discharged from a specialist children's hospital and their care is transferred to a regional or rural area. Whilst parents universally described the care received by their children in the specialist children's hospitals as excellent, they nevertheless encountered severe problems when they took their children back to their local areas and tried to obtain the medical care required from their local hospitals.

- 5.50 The reasons for this difficulty are not hard to fathom.

Rare conditions

- 5.51 Some of the children who are discharged from the specialist paediatric hospitals have quite rare conditions, and even local paediatricians may not have seen some of the sorts of problems that can arise. An example was provided by the evidence of Francis Dillon at Wagga Wagga.

Francis Dillon gave evidence in Wagga Wagga about the delays in the local hospital devising a management plan for his daughter. Mr Dillon's daughter has a comparatively complex and unusual medical condition, a connective tissue disorder called Ehlers-Danlos Syndrome.⁷⁵ Mr Dillon told me that his daughter had received reasonably good treatment at Sydney Children's Hospital and the Children's Hospital at Westmead. However, he said, the Emergency Department staff and orthopaedic registrars at the local hospital did not seem to have, with one exception, the requisite knowledge about the patient's condition, nor the skills to appropriately treat her. In his view, whenever his daughter has received treatment at that hospital it has been extended, caused a great deal of unnecessary pain, and has from time to time been inappropriate.⁷⁶

- 5.52 This is a 'critical mass' issue because only staff that deal with a large volume of particular types of patients are likely to encounter some of these rare conditions.⁷⁷

Unusual treatments

- 5.53 The children may have medical devices inserted, such as tracheotomies or PEG tubes (percutaneous endoscopic gastrostomy tubes, that are inserted into the stomach used to provide nutrition to patients who are unable to swallow), which require attention from local nurses unfamiliar with the devices.

"... I have discharged babies who need tube feeding to areas like Broken Hill, Orange and Coffs Harbour. Locating resources in these areas who feel confident in supporting families with tube changes and ongoing equipment can be tricky ... Because this experience is not readily available in the community, the infants are then brought back to the Children's Hospital at Westmead to get a follow-up."⁷⁸

- 5.54 It is understandably difficult for staff in rural areas to keep their skills up for particular procedures because they may only see one or 2 children presenting every few months, if at all.⁷⁹ A simple procedure in a specialist paediatric hospital may become complicated in a local hospital. This sometimes leaves parents with the only option to take their child to a specialist children's hospital.

- (a) Mr and Mrs Hooley gave evidence at Tamworth about difficulties obtaining medical help for their 2 year old son, who is fitted with a PEG tube.⁸⁰ They told of problems getting effective medical support at Tamworth Hospital, as the staff were unfamiliar with the machinery and tubes. If the tube ever comes out of their son's stomach, the family travels to Newcastle to have it re-inserted as there are no gastroenterology surgeons in Tamworth.⁸¹
- (b) I heard of similar difficulties in Port Macquarie where Mrs Brett's child, Noah, has a tracheostomy. Unfortunately, there are few nurses at Port Macquarie Hospital trained to deal with tracheostomies and Mrs Brett does not feel that she can leave her child there unattended.⁸²

"Kids with tracheostomies, particularly kids that are disabled physically as Noah, are really vulnerable. He has no way of getting attention if he needs it. He can't press the buzzer, he can't yell out for help, he can't say, 'Hey, I'm not breathing, I need some suction.'⁸³

Local staffing levels

- 5.55 The nursing staff may not have the staffing levels, expertise, training or confidence to provide the high levels of care needed by some babies or children.
- 5.56 For example, nurses from the Children's Hospital at Westmead told me of a 9 year old girl with catastrophic brain injury as a result of uncontrollable seizures. After having an extensive period in the intensive care unit, the patient is now in a post-coma unresponsive state⁸⁴ and is essentially receiving palliative care. The girl's family, understandably, don't have the confidence to take her from Children's Hospital at Westmead straight home but are having difficulty negotiating with their local hospital to take over her care. The nursing staff at the local hospital have very limited resources and it would be very difficult for them to accept a girl with such complex support needs.⁸⁵

Assistance from the specialist hospital

- 5.57 I did hear evidence of some successful efforts to support the transfer of care of complex paediatric patients. This was achieved through great effort and preparation. In addition, clear lines of communication were established between the specialist children's hospital and the hospital accepting care so that advice and help was only a phone call away.
- (a) I heard an example at Children's Hospital at Westmead where, last year, some of the staff transferred the care of a child to a rural area. As part of the discharge process, they went to the local area for 3 days and provided intensive training support for the staff. They made a DVD that explained her complex needs and what to do for tracheotomy changes, ventilation and so on. After the child was discharged, they went back for 2 days to provide ongoing care and assistance to the staff and have maintained a relationship since then.⁸⁶
- (b) Another example from the Sydney Children's Hospital is the work of the oncology unit in up-skilling referring hospitals to share care. They have 2 outreach nurses in rural areas and one in the metropolitan area who are teaching procedures, visiting GPs, paediatricians, school teachers and classes. There are 22 outreach clinics held each year, one every 3 months. This is a shared care model with the Sydney Children's Hospital remaining the liaison point for parents.⁸⁷
- (c) I heard that the largest group of patients where long-term care is required and transfer is particularly an issue are those who require long-term ventilation. A unit has been set up at Children's Hospital at Westmead to help support transition and engage families to be able to care for their children in the community.⁸⁸ I have dealt elsewhere in my report with the difficulties in obtaining long term residential care for complex paediatric patients.
- 5.58 Due to the lack of established protocols and procedures in place, every time that a patient is discharged from a specialist children's hospital back home the staff are faced with the challenge of designing and coordinating the ongoing care of the patient.

"... every time we organise a complex discharge, it is almost like starting the wheel again. It will be something new."⁸⁹

- 5.59 It was suggested to me that case managers should be nominated for these complex cases so that the services that are provided are neither fragmented or unnecessarily repeated or overlapping. These case managers need to be able to look after the co-morbidities locally.

"... there is little in the way of case managers experienced in working with chronic and complex infants or children who look at the whole child with many co-morbidities, and who are based locally. As a result the services provided to these children are either fragmented or doubled up, and accessibility of health is questionable."⁹⁰

Obstacles from area health services

- 5.60 I was concerned to hear evidence that specialist children's hospitals experience difficulty getting co-operation from area health services in order to transfer complex paediatric patients back to their local areas. The consequence may be that children stay in a specialist children's hospital much longer than they need to, often a long way from their families, until these obstacles can be overcome.⁹¹

- 5.61 I was told that each area health service has its own processes for transfer and that children's hospital staff have to go to each area health service and see what is available and what their processes are.⁹²
- 5.62 Referrals of such patients to an area health service have to go from chief executive to chief executive. This adds complexity and delay as some area health services refuse to accept the care of a child. At the moment there is no particular incentive for an area health service to agree to accept such care, because the specialist children's hospital will continue to provide the child with care if they cannot be transferred.⁹³
- 5.63 It was suggested to me that there needs to be clearer delineation of responsibilities for the care of such patients between the area health service and the specialist children's hospitals.⁹⁴
- 5.64 One suggestion for improvement of this situation was for a state-wide unit based at a children's hospital that registers complex children and coordinates their care with other area health services. This would provide a point of contact for non-specialist hospitals so that they had a degree of security about looking after that child and would assist in dealing with and reducing any administrative problems.⁹⁵ I was told that such a model is used in Victoria, as described below.

At the Royal Children's Hospital, community care is co-ordinated through the Home & Community Care program located on the grounds of the hospital. This program offers Hospital in the Home, post acute care, the Family Choice program and palliative care. The Family Choice Program is a state-wide program that provides home based support to families of children with high levels of complex ongoing medical care needs. The support provided is tailored to the needs of the particular family and based on a case management and individualised medical care plan approach. The program is for children whose families are expected to experience difficulties in maintaining the high level of ongoing medical care at home, for example, where the child has a tracheostomy (artificial airway) requiring frequent suction to clear secretions, tube feeding, frequent delivery medication via a feeding tube, and constant monitoring and management of frequent seizures with medication. The aim of the Family Choice Program is to assist the families of children with complex, chronic medical care needs who can be cared for at home with their families. To be eligible for the program the patient must be aged between birth and 17 years: when they turn 18 years, they are no longer eligible for the program. The child's family must live in Victoria and must require case management and extra funding to meet their child's needs at home. The child must also require complex interventional medical related care which either may occur unpredictably during a 24 hour period, or daily; for example, frequent suctioning of nose or mouth; medication into a vein; or involve a tracheostomy care and gastrostomy feeding.⁹⁶

- 5.65 Clearly such a program would be of great benefit to children who have complex needs, and to their families who presently struggle in NSW without a single co-ordinated approach to the child's care. I am of the view that a specialist health authority for children and young people, which I discuss further elsewhere in this chapter, will be well placed to deal with these issues.

Transition of complex paediatric patients to adult hospitals

- 5.66 With advances in modern medicine, in particular, neo-natal intensive care, children who would not have survived for any length of time in previous decades are now growing into adults, often with ongoing serious disabilities or rare conditions for which there are no established specialities outside paediatric medicine. In the last 2 years at Children's

Hospital at Westmead alone, the survival rate for newborns in the intensive care unit has increased from 82% to over 97%.⁹⁷

- 5.67 Whilst the care that these patients receive as children is excellent, it is still difficult for such patients to get the care they need in adult hospitals. Many continue to receive treatment at specialist children's hospitals long after they have become adults.

"... we now have a whole generation of children who are adults who don't have services that they can be adequately transitioned to. That has a knock-on effect of us being in the awkward or difficult situation of having to continue to manage children in adulthood in a children's hospital."⁹⁸

- 5.68 I was told of several examples.

- (a) Patients with cerebral palsy continue to need orthopaedic procedures, such as joint replacements or leg straightening, to keep them mobile and out of nursing homes. when they are adults. This care is ongoing and quite substantial.⁹⁹

I heard evidence in Albury from the mother of a patient who has cerebral palsy. As a child, the patient received good specialist care. However, when he became an adult, he entered the adult system without any formal transitioning. The responsibility for sourcing specialist care became the mother's responsibility. She regularly experienced great difficulty having her son admitted into hospital. The mother said that she often had to get a community paediatric doctor to speak to the Emergency Department to convince them to admit him to hospital.¹⁰⁰

- (b) Phenylketonuria, or PKU, is a genetic condition that effects the body's ability to metabolize a particular amino acid. When it is not treated properly, it can cause serious intellectual disability. Due to the diagnoses of this condition through newborn screening for the last 20 years, we now have a generation of adults with PKU who need ongoing care for the disease.¹⁰¹
- (c) Cystic fibrosis¹⁰² is a condition that affects the glands in the lungs and other organs and can be increasingly debilitating condition as the patient gets older.

- 5.69 Many such patients have very severe physical and/or intellectual impairment with complex needs requiring multi-disciplinary care.¹⁰³ This is harder to come by in adult hospitals.

"One of the problems we face, and the families we look after face, is that in children's hospitals we are very well geared up to that kind of approach to managing these complex patients, but once they become adults, then the provision of services to those kinds of individuals becomes very fragmented."¹⁰⁴

- 5.70 The increase of specialisation in adult medicine has meant that overall co-ordination for care in many complex adult patients is greatly lacking until one reaches the age range allocated to geriatricians. Whilst paediatric medicine tends to be more generalist in nature, once a patient transitions to adult care, difficulties emerge. Recently, staff at Sydney Children's Hospital asked a geriatrician to be the case manager for an 18-year-old patient with multiple organ difficulty to obtain co-ordination of the range of different types of care that were required. Whilst not ideal, this option was considered to be better than the alternative of leaving the adolescent without any case manager.¹⁰⁵

- 5.71 In my view, there needs to be a better mechanism for managing such patients, and assisting them in transferring to adult services, to ensure that they receive the care they need, wherever they live in NSW.

5.72 It was suggested to me that there should be a single centre, or perhaps 2 centres, to develop expertise in the treatment of adults with these rare conditions.

"I think that the ideal situation [is] where you have a single organisation that has the ability to develop the expertise and maintain the expertise."¹⁰⁶

A suitable place for such a centre was said to be Westmead Hospital, as this would permit easier interaction between the clinical staff at the Children's Hospital at Westmead and the adult hospital.¹⁰⁷

5.73 The Greater Metropolitan Clinical Taskforce has done some work in the issue of transitional care through its Transition Care Network.¹⁰⁸

- Summaries of service gaps and ideal models of care for a broad range of chronic illnesses / disabilities were submitted to NSW Health in early 2007.
- Working groups have been established for the top 3 conditions (diabetes, spina bifida and developmental disability) to develop transition models.
- Transitional care has been included in Clinical Service Plans for South Eastern Sydney / Illawarra, Hunter / New England and Northern Sydney / Central Coast area health services.
- The Greater Metropolitan Clinical Taskforce has developed local transition committees between the 3 specialist children's hospitals and their adjoining adult hospitals. 'Graduation ceremonies' and information forums have been implemented at Sydney Children's Hospital and the Children's Hospital at Westmead.
- I am told that there were 284 referrals to the Greater Metropolitan Clinical Taskforce Transition Service from paediatric clinicians in 2007, an increase of 160% on referrals for 2006.¹⁰⁹

5.74 The work of the Greater Metropolitan Clinical Taskforce is a start in resolving the issue of transition to adult services, but as yet, a state-wide approach has not been developed. It concerns me that until it has, some patients will still be abruptly transferred to adult services, over-stay in paediatric facilities, or leave medical supervision altogether.¹¹⁰

Children and Young Peoples' Health Authority ("NSW Kids")

5.75 There can be no doubt that paediatric medical services are of great importance. Early treatment of paediatric conditions has life long benefits for these young patients. A sound future for paediatric medical services is a foundation stone for health care in NSW for many years to come.

5.76 It concerns me that in NSW there is a currently a lack of co-ordination of paediatric and young person's health care in public hospitals throughout the state.

5.77 There is an issue whether the current geographically based area health service organisation is an impediment to the efficient, safe and cost-effective delivery of health care to children and young people.¹¹¹

"The way paediatric services exist in this State, the way the flows occur, the way services are delivered, an area health service based model cannot alone address it adequately. It needs to be addressed in conjunction with other players at a statewide level."¹¹²

- 5.78 As Professor Leslie White, Executive Director, Sydney Children's Hospital, told me,
- "Fragmentation is the best descriptor of what we currently have."¹¹³
- 5.79 It was suggested to me that the delivery of child and young persons' health care would be best if it were organised as a single functional health authority for the entire state.¹¹⁴
- "A systematic state-wide approach to planning, implementing and monitoring of paediatric services is recommended."¹¹⁵
- 5.80 It was argued that the advantage of a paediatric specific service would be that the co-ordination of various services could be managed by one central authority and support services provided to whomever required them.¹¹⁶ This does not currently happen.¹¹⁷
- 5.81 After having spoken to many of the leading authorities on paediatric and young people health services, it has become obvious to me that what is required is a single state-wide authority that provides for the full range of medical care for children and young people. This solution was supported by a range of professionals working in providing services for babies, children and young people.¹¹⁸
- 5.82 This of course would involve an amalgamation of all paediatric inpatient facilities, whether they be in specialist children hospitals or in general hospitals under the control of that single authority. It would also involve combining the vast range of community activities including prevention activities, early intervention activities and ongoing specialist help under such an authority.
- 5.83 It is argued that the benefits would be that a fairer distribution of resources on a state level could occur so that when the inevitable increase in the demand for the provision of health care for people over the age of 65 occurs, investment in child health and the health of adolescents is not overlooked or given any lesser priority.
- 5.84 It is clear that the provision of inpatient hospital services to children and young people is, speaking generally, on a per person basis, more expensive than the provision of adult health care. Nursing ratios are different. It takes longer to undertake most interventions with children than it does with adults. Surgery is often more complicated.
- 5.85 There is a need to provide dedicated beds for child patients, given the takeover of beds by adults in NSW hospitals, particularly chronic and complex patients. The increasing demand for beds has adults in paediatric wards and children in adult wards. As Ms Crittenden, Northern Child Health Network Coordinator, told me at John Hunter Hospital,
- "...management is insisting that they co-locate adults with children [in one ward] ...
- "but it is well known and documented that for the security of children in hospital that we actually should not co-locate adults and children in the same inpatients area."¹¹⁹
- 5.86 Such a practice which is to my observation quite widespread throughout public hospitals in NSW not only fails to meet the standards dictated by best practice but is risky to the welfare of the child and potentially harmful to their recovery from illness. Most right thinking people would be surprised, perhaps horrified, that this practice is not uncommon across NSW.
- 5.87 It would be an understatement to say that one of the impediments to any such single authority, and the proper concentration of paediatric health care into appropriate sized

and staffed units, is the history of the development of specialist children's public hospitals in NSW and the rivalries which have developed over time between these institutions, the Universities to which they were attached and the strong-willed personalities of a variety of clinicians involved in their development. I express no view as to whether that competition has been healthy or not. Nor would it be fruitful, in considering the future, to trawl through the anomalies of the past.

- 5.88 I do note, however, that international research tends to suggest that consolidation of speciality care into one unit leads to better patient outcomes. For example, I was told that at present in the Sydney metropolitan area it is not possible to staff both of the existing Paediatric Intensive Care Units with a specialist intensivist in the units 24 hours a day for 7 days a week because of a lack of specialists, whereas by combining them, it would be possible so to do. This would greatly improve the quality of the service and be cost neutral.¹²⁰ Such an argument is compelling and it is also supported by world-wide experience.

A study conducted as part of the McKinsey's Report compared the provision of paediatric intensive care units in Trent in the U.K and Victoria. It was found that the mortality rates in the paediatric intensive care units in Trent, where the units are fragmented, were nearly 50% higher than in Victoria, which is significantly larger geographically, but with only 2 units in the entire state.¹²¹ At the least, the comparison suggests that for patients in these units, consolidation is preferable to fragmentation in terms of outcomes.

- 5.89 However, I venture to suggest that, for those who seek to concentrate on, and perpetuate the historical rivalries to which I have drawn attention, there is a tendency to miss the real point. The real point is this. How can the health care of children and young people best be addressed throughout the state? How is it that we can make sure that a child in Walgett has access to the same standard and quality of health care as a child who lives in Woollahra, Waratah or Wallerawang? How is it that we can make sure that specialist clinicians can deploy their skills for all of the children of NSW and not just for those who live in parts of the major cities?
- 5.90 In recommending the creation of such a structure, I am confident that it would be a lasting legacy for the future which builds upon the valuable work done by the existing child health networks.¹²²
- 5.91 This approach has been taken in Queensland, where Queensland Health has restructured the Queensland paediatric service into a new children's health service district. The role of the Children's Health Service District is the construction of a children's hospital, and co-ordination of all tertiary level paediatric services and the secondary paediatric service network within the greater Brisbane metropolitan region.¹²³
- 5.92 The response to what I have proposed was largely very positive.¹²⁴ Dr Ralph Hanson Director, Information Services and Planning, Childrens Hospital, Westmead said
- "I do believe the solution lies in an integrated service model, and that means change. It is interesting that, when I said to the colleagues at work, 'Do you agree with what I'm going to say?', they said, 'We need change. We are sick of the competition. We are sick of being at loggerheads. We all need to focus on what we are trying to do.'"¹²⁵
- 5.93 Some questions remain as to the scope of NSW Kids.

Mental health

- 5.94 A question is whether NSW Kids should include child and adolescent mental health. In my view, it should. I was largely supported in this view by the clinicians who I consulted.¹²⁶ On the other hand, community mental health workers at St George cautioned that child and adolescent mental health services must have good relationships with adult mental health services to assist with referrals.¹²⁷ I agree that it would be vital for this close liaison to occur.

Community health

- 5.95 In the community there is a need for a greater emphasis on prevention and early intervention with children and young people than there is with adults. As well, the results of such programs are not always immediately visible in the community because what is being aimed at is the longer term health and welfare of the younger members of society.

- 5.96 As an example, early vaccination programs can provide life-long protection from disabling disease which may have adult onset. Early intervention in children with behavioural disorders would be expected to result in better educational and vocational outcomes, but these won't be apparent for many years. The results are sometimes seen in an all-of-government sense where early intervention keeps young people out of the juvenile justice system.

- 5.97 This lack of visible, immediate results can and does lead to an under-emphasis on the community aspects of care for the health of children and young people. When there is competition for scarce monetary resources, this side of health care is often ignored or given a lower priority. I am fearful that, with the increase in demand for healthcare services for adult chronic and complex patients, which I discuss in Chapter 3, there will be irresistible budgetary pressure which will overtake these prevention and early intervention programs for children and young people.

- 5.98 I was cautioned that combining acute care services in public hospitals with community services may lead to an imbalance between the two, with inadequate emphasis being placed on community services.

- (a) It was suggested to me that a proportion of the budget should be allocated to community health so that the acute care services do not swallow all of the available funds;

"... funding for outpatient paediatric services [should] be quarantined ... to prevent it being used for competing health care priorities and ... in tangible recognition of its high status as the cornerstone of effective health care service provision."¹²⁸

- (b) As a senior health executive explained to me,

"We have to be absolutely clear on what is being included because child health is the one area where we currently have a significant emphasis on health as opposed to disease management... [T]he greatest jewel we have in the crown in this area is the services that are provided that are health services and not illness management services."¹²⁹

- 5.99 Whilst this caution is well expressed, the combination of both acute care hospital based services with community services for children and young people into a single budget-

holding authority is likely to provide for greater certainty in securing this balance than allowing it to remain in the area health services.

- 5.100 At present, the proportion of expenditure seems to be about 65% on acute care in public hospitals and about 35% on care in the community including prevention and early intervention programs. I am told that this is a reasonable balance between the two, although some would advocate for an even split.
- 5.101 I see no reason for the present balance to be disturbed. However, I am not persuaded that there is any effective way of “ring-fencing” the budget so as to require a fixed expenditure percentage on community services. I believe that this is a matter which can be left to the good sense of those entrusted with the running of the authority.

Rural areas

- 5.102 Some concerns were expressed about how this would work in rural areas, where the same health professionals provide services to child and adult patients. For example, Dr Jackie Andrews, a community paediatrician, told me:

“We have small centres where there is one physio. She covers the ward. She does adult outpatients and child outpatients. I’d hate to see her become totally at odds, which would mean that our families would have to drive another hour to get to a physio who can see their child, because I know for some families they just won’t do it. We need to work out some sort of way that we can fund part of their time for paediatrics, if that’s how we are going to change the model.”¹³⁰

- 5.103 I recognise that, in such a facility as that referred to, it would be inappropriate to require separate staff members to provide services to adult patients and children. However, I see no difficulty in the costs of that staff member’s services being appropriately shared between the area health service and NSW Kids. NSW Kids would have the obligation of ensuring that the individual was appropriately skilled in the provision of those services and in being kept up to date with the appropriate models of care to be provided.
- 5.104 Whilst details of this kind are properly matters of concern, particularly for rural services, I see these matters as falling within the range of issues for attentive management to address rather than as impediments to the success of this most significant recommendation.
- 5.105 Finally, on the question of the scope of NSW Kids, NSW Kids should establish and maintain close links with maternal and perinatal health services conducted throughout NSW in order to promote the health and well-being of unborn children, at the same time as, and in conjunction with, the promotion of maternal health and well-being.

NSW Paediatric Hospital

- 5.106 It was suggested to me by a number of witnesses that there should only be one specialist children’s hospital in metropolitan Sydney, rather than the existing arrangement.¹³¹ One reason for this suggestion was that the present configuration of hospitals is inefficient and potentially unsafe, and involves unnecessary duplication of specialist services.¹³² It may also be that “critical mass” is needed for a specialist facility to work with safety to deliver good quality services.

- 5.107 I was also informed that in May 2008, the ACT Government announced a proposal to construct a specialist Women and Children's Hospital on The Canberra Hospital campus at Woden.¹³³ It is unclear to me, because it was not part of my function to investigate the detail of this proposal, what configuration of services are to be provided within the hospital which relate to children and young people.
- 5.108 It would be unfortunate, given the geographical propinquity of the ACT to NSW, if liaison did not take place with the aim of ensuring that services were not unnecessarily duplicated between specialist hospitals whether in NSW or the ACT, because such duplication would have the effect of raising the same safety and quality issues which are raised by the historical position in NSW.
- 5.109 A study conducted as part of the McKinsey Report, to which I made reference earlier, compared the population required to obtain critical mass to support a tertiary paediatric hospital. It was generally concluded that a population of 3.5 to 5 million people could only support one tertiary paediatric hospital.¹³⁴ Whilst such a study needs to be considered in the light of particular geography, nevertheless, there remains room for ensuring that any ACT proposal and the recommendation of this Inquiry ought take advantage of synergies and efficiencies which would benefit all of the children in both NSW and the ACT.

Queensland

- 5.110 The same decision has been made in Queensland.
- 5.111 I was told by Professor Allan Isles, Acting CEO, Queensland Child Health Services District, that Queensland has historically had 2 specialist children's hospitals – the Mater Children's Hospital and the Royal Children's Hospital – 5.6km apart and within the centre of the city.¹³⁵ In early 2006, there was a review of paediatric cardiac services which recommended a single specialist children's hospital.¹³⁶ A ministerial taskforce was established, with the goal of consolidating all tertiary paediatric services into a single new hospital to be called the "Queensland Children's Hospital".¹³⁷ Since then, Professor Isles informed me, an historically competitive relationship between the 2 specialist children's hospitals has merged into a progressively constructive and collaborative relationship.
- "[T]he fact that we are able to bring these two hospitals together and get them to work constructively and collaboratively is evidence that whilst it is not easy, it can actually be done, and relationships have been fundamentally transformed."¹³⁸
- 5.112 A key consideration in Queensland's thinking on this topic was the issue of critical mass.¹³⁹ Professor Isles was guided by the McKinsey Report relating to Ireland (which I have discussed further below) which identified that to be truly effective as a tertiary hospital you need to be serving a population of 3.5 to 5 million people.¹⁴⁰ I was told that the population of Queensland is about 4 million and for it to persist with the 2 hospital model meant that it would never achieve critical mass and efficiencies of scale which would come from having a single service.¹⁴¹ Nor would the safety and quality of their services be optimal. I was also told that it will be more effective in achieving critical mass and efficiencies if the main hospital was supported by a network of secondary level hospitals.¹⁴²

Ireland

- 5.113 Ireland has also taken this approach. With a population of about 4.2 million, the paediatric health service was provided by 3 specialist children's hospitals all in Dublin.¹⁴³ This presented several problems:
- the hospitals competed rather than co-operated;
 - specialist services were not all on one site; and
 - each hospital suffered from poor infrastructure and there were significant difficulties in rectifying these problems if rebuilding on same site was necessary.¹⁴⁴
- 5.114 The McKinsey Review¹⁴⁵ commissioned for the project suggested that Ireland should centralise its specialist services to create a critical mass and that, accordingly, there should be one children's hospital, which should be co-located with an adult hospital.¹⁴⁶ This hospital was to be supported by secondary care as follows,

"The idea was that some of the secondary care could be delivered in an outreach centre on the other side of the city, depending on which side of the city was selected for this hospital and there could be more than one of these as they call them, urgent care centres."¹⁴⁷

The way forward

- 5.115 Clearly, one of the early considerations for NSW Kids will be to investigate the question of what is the best configuration for the delivery of all acute care services in public hospitals in NSW. This will involve identifying the paediatric wards located in general adult hospitals which will be suitable for the provision of secondary services. As well, it will involve determining the best configuration for the delivery of tertiary and quaternary services and the location (or locations) at which those services ought be provided.
- 5.116 Relevant to this task will be the consideration of the principles of critical mass sufficient to support the efficient provision of services with appropriate levels of safety and quality. As well, consideration will need to be given to the question of the suitability of the design of the existing specialist children's hospitals for the demands of modern day acute care services, including the present state of maintenance and repair of the buildings and their flexibility for upgrade. Consideration will also need to be given to the likely location of the bulk of the children and young people throughout NSW and therefore their proximity to any specialist hospital.
- 5.117 All of these hospital services need careful planning involving the clinicians delivering the services. It is not appropriate for me to express any view as to where such hospital services ought be located – that is a matter for experts. It is not a matter for local lobbyists and lobbying by entrenched interests. Any new specialist children's hospital providing tertiary and quaternary services (if that be the ultimate option chosen) ought logically be in Sydney, however it is a hospital for all of NSW and must be able to service all of NSW.
- 5.118 The arguments put to me which suggest that this hospital has not yet been built are probably correct. There are problems in the existing facilities at the 3 specialist children's hospitals in terms of condition, design and size which are not readily solved on the existing sites. As well, both Melbourne and Brisbane are presently engaged in upgrading their specialist children's hospitals to provide a new state of the art facility for children and young people in those states. It would be ignoring reality to think that clinicians presently providing services in NSW will not be attracted by these facilities and that the NSW specialist paediatric workforce, which is already in short supply in

Australia, may be further diminished by being able to practise their profession in more modern facilities than those provided in NSW.

Recommendation 9: *Within 6 months, NSW Health should establish, as a chief-executive governed statutory health corporation pursuant to s.41 of the Health Services Act 1997, a Children and Young Peoples' Health Authority ("NSW Kids").*

The function and role of NSW Kids will be to provide all health care for children and young people, throughout NSW, whether in the community, or in a public hospital, commencing with neo-nates who require tertiary or higher level services and concluding with young people at the end of their sixteenth year of life.

The guiding principle of NSW Kids is that the paramount consideration in the provision of health care is the promotion of the health and well-being of the population and the prevention, diagnosis, treatment and cure of the illnesses of the population in a manner which best promotes the wellbeing of children and young people.

The principal purposes of NSW Kids are to include, at least:

- (a) The striking of, and the maintenance of, a proper funding balance between the provision of community based services, including inter-agency co-operation and prevention measures, and the provision of acute care and related services in public hospitals;*
- (b) Ensuring that the standard of all health care provided to children and young people throughout public hospitals in NSW is consistent and is undertaken, so far as possible, in facilities or parts of facilities which are designated and set aside for such care and which do not include the provision of care for adults; and*
- (c) Ensuring that there are adequate services and facilities for the provision of mental health care to children and young people.*

The secondary purposes of NSW Kids are to include, at least:

- (d) the provision of education and training to all clinicians about the health and well-being of children and young people;*
- (e) the provision, either alone or in conjunction with NSW Health and the Area Health Services, of public education, including preventative health and wellness campaigns, which promotes the health and well-being of children and young people throughout NSW; and*
- (f) the commissioning, conducting, supporting and supervision of research into the health and well-being of children and young people.*

Recommendation 10: *Within 12 months, NSW Kids should publish and implement, a strategic service delivery plan for the health care of children and young persons so as to ensure that appropriate treatment is delivered by appropriately skilled clinicians in the appropriate facility or else as a community based service. Such plan is to delineate clearly which health service is to be provided in which facility or class of facilities, including the criteria for transfer between facilities, and should, so far as clinically appropriate, avoid the duplication of services between facilities. In the*

development of the strategic service delivery plan, NSW Kids, determine whether it is in the best interests of the health of children and young people that all Sydney metropolitan area based intensive care units (providing tertiary and quaternary care for neo-natal and paediatric patients) should be combined into a single unit at a single facility and whether there should be established a similar facility at the John Hunter Children's Hospital.

Recommendation 11: *Within 18 months, NSW Kids should investigate and report to NSW Health and the Minister for Health on the need for, the desirability of, and the possible locations of a new NSW Kids hospital providing quaternary and tertiary facilities. Any such report needs to include preliminary costings for and a business case which analyse the best options for a new NSW Kids hospital.*

- ¹ NSW Health, *Bed Types Categories for Inpatient Units from 1 March 2008*, PD2008_034: see domain definition for 'Paediatric' bed type.
- ² The level 6 paediatric hospitals are required to be supported by level 6 pathology, pharmacy, diagnostic imaging and nuclear medicine as defined in NSW Health Statewide Services Development Branch, *Guide to the Role Delineation of Health Services*, 3rd edition, 2002, NSW Health Department, North Sydney, p. 52.
- ³ The Children's Hospital at Westmead, *Annual Report 2007*, 2007, The Children's Hospital at Westmead, Westmead, p. 20.
- ⁴ The Children's Hospital at Westmead, *Annual Report 2007*, 2007, The Children's Hospital at Westmead, Westmead, p. 20.
- ⁵ South Eastern Sydney Illawarra Area Health Service, NSW Health, *South Eastern Sydney Illawarra Area Health Service Annual Report 2006-2007*, South Eastern Sydney Illawarra Area Health Service, Wollongong, p. 22.
- ⁶ South Eastern Sydney Illawarra Area Health Service, NSW Health, *South Eastern Sydney Illawarra Area Health Service Annual Report 2006-2007*, South Eastern Sydney Illawarra Area Health Service, Wollongong, p. 28.
- ⁷ Material provided by Hunter New England Area Health Service in response to summons, HNE.001.0128 at 131.
- ⁸ 2002-3 data: Kaleidoscope, Hunter Children's Health Network, John Hunter Children's Hospital and Community Child Health, *Annual Report 2003*, 2003, p. 33.
- ⁹ Australian Bureau of Statistics, Population by Age and Sex, Australian States and Territories, Jun 2002 to Jun 2007, Cat no. 3201.0, Canberra: ABS [http://www.ausstats.abs.gov.au/ausstats/subscriber.nsf/0/F3311A71B125E0FBCA2574740015BBA6/\\$File/32010DO001_2002200706.xls#TopOfTable](http://www.ausstats.abs.gov.au/ausstats/subscriber.nsf/0/F3311A71B125E0FBCA2574740015BBA6/$File/32010DO001_2002200706.xls#TopOfTable) Table 6 (13 November 2008).
- ¹⁰ Letter from NSW Health to the Special Commission of Inquiry, 28 August 2008.
- ¹¹ Sawyer MG, Arney FM, Baghurst PA, et al, *Mental Health of Young People in Australia: Child and Adolescent Component of the National Survey of Mental Health and Well-being*, 2000, Commonwealth of Australia, Canberra.
- ¹² Sawyer MG, Arney FM, Baghurst PA, et al, *Mental Health of Young People in Australia: Child and Adolescent Component of the National Survey of Mental Health and Well-being*, 2000, Commonwealth of Australia, Canberra, Table 3.2, p. 10.
- ¹³ Sawyer MG, Arney FM, Baghurst PA, et al, *Mental Health of Young People in Australia: Child and Adolescent Component of the National Survey of Mental Health and Well-being*, 2000, Commonwealth of Australia, Canberra, p. xii.
- ¹⁴ Australian Bureau of Statistics, *Health of Children in Australia: A Snapshot, 2004-05*, Cat no. 4829.0.55.001,

<http://www.abs.gov.au/AUSSTATS/abs@.nsf/allprimarymainfeatures/9C310A5E79B9BF7C CA256F390074DF3E?opendocument> (14 October 2008).

- 15 Australian Bureau of Statistics, *National Survey of Mental Health and Wellbeing: Summary of Results*, 2007, Cat no. 4326.0.
[http://www.ausstats.abs.gov.au/ausstats/subscriber.nsf/0/6AE6DA447F985FC2CA2574EA00122BD6/\\$File/43260_2007.pdf](http://www.ausstats.abs.gov.au/ausstats/subscriber.nsf/0/6AE6DA447F985FC2CA2574EA00122BD6/$File/43260_2007.pdf) (5 November 2008), p. 9.
- 16 Australian Bureau of Statistics, *National Survey of Mental Health and Wellbeing: Summary of Results*, 2007, Cat no. 4326.0.
[http://www.ausstats.abs.gov.au/ausstats/subscriber.nsf/0/6AE6DA447F985FC2CA2574EA00122BD6/\\$File/43260_2007.pdf](http://www.ausstats.abs.gov.au/ausstats/subscriber.nsf/0/6AE6DA447F985FC2CA2574EA00122BD6/$File/43260_2007.pdf) (5 November 2008), p. 9.
- 17 Australian Institute of Health and Welfare (AIHW), *Australia's Health 2008*, 2008, AIHW, Canberra, p. 280.
- 18 Australian Institute of Health and Welfare (AIHW), *Australia's Health 2008*, 2008, AIHW, Canberra, p. 284.
- 19 Australian Institute of Health and Welfare (AIHW), *Australia's Health 2008*, 2008, AIHW, Canberra, p. 284.
- 20 Centre for Epidemiology and Research, NSW Health, *NSW Emergency Department Data Collection (on HOIST)*, 20 August 2008, provided in letter from NSW Health to Special Commission of Inquiry (Request No. 135), 13 November 2008.
- 21 Submission of Dr David Dossetor, 15 May 2008, SUBM.077.0087 at 88.
- 22 Dr David Romney Dossetor, Children's Hospital, Westmead, 15 May 2008, transcript 2921.20-22.
- 23 Information provided during visit to Children's Hospital, Westmead on 15 May 2008.
- 24 Submission of Dr David Dossetor, 15 May 2008, SUBM.077.0087 at 87.
- 25 Dr Elisabeth Murphy, Paediatric Experts' Conference, 29 September 2008, transcript 123.26-29.
- 26 Letter from NSW Health to the Special Commission of Inquiry, 28 August 2008.
- 27 Submission of Dr David Dossetor, 15 May 2008, SUBM.077.0087 at 88.
- 28 Submission of Dr David Dossetor, 15 May 2008, SUBM.077.0087 at 88.
- 29 Submission of Dr David Dossetor, 15 May 2008, SUBM.077.0087 at 88.
- 30 Information provided during visit to Cumberland Psychiatric Hospital on 13 May 2008.
- 31 Information provided during visit to St George Community Mental Health Centre on 3 September 2008.
- 32 Charlene Brown, Wagga Wagga hearing, 22 April 2008, transcript 2031.40-47.
- 33 Professor Alan Rosen and Dr James Telfer, Royal North Shore Hospital hearing, 14 March 2008, transcript 372.22-28.
- 34 Submission of the Australian Confederation of Paediatric and Child Health Nurses (NSW Branch) Inc, 27 March 2008, SUBM.014.0007 at 10-11.
- 35 Information provided during visit to Wollongong Community Mental Health Centre on 3 September 2008.
- 36 Information provided during visit to Kenmore Hospital and Chisholm Ross Centre on 16 April 2008.
- 37 NSW Health, *NSW Community Mental Health Strategy 2007-2012*, 2008, NSW Department of Health, North Sydney, p. 35.
- 38 NSW Health, *NSW Community Mental Health Strategy 2007-2012*, 2008, NSW Department of Health, North Sydney, p.35-37.
- 39 Letter from NSW Health to Special Commission of Inquiry, 24 October 2008.
- 40 Professor Kay Wilhelm, Paediatric Experts' Conference, 29 September 2008, presentation at 7.
- 41 Confidential Children's Hospital, Westmead hearing, 15 May 2008, transcript 38.9-24.
- 42 Dr Mary McCaskill, Children's Hospital, Westmead hearing, 15 May 2008, transcript 2933.28-31.

-
- 43 Information provided during visit to the Children's Hospital, Westmead on 15 May 2008.
- 44 Dr Mary McCaskill, Children's Hospital, Westmead hearing, 15 May 2008, transcript 2934.23-25.
- 45 Dr Mary McCaskill, Children's Hospital, Westmead hearing, 15 May 2008, transcript 2934.17-21.
- 46 Dr Mary McCaskill, Children's Hospital, Westmead hearing, 15 May 2008, transcript 2934.36-43.
- 47 Confidential Sydney Children's Hospital hearing, 19 May 2008, transcript 37.24.
- 48 Confidential Sydney Children's Hospital hearing, 19 May 2008, transcript 37.32-39; 39.44-46.
- 49 Information provided during visit to Royal Prince Alfred Hospital on 20 May 2008.
- 50 Letter attached to submission of Annette Wright, 14 April 2008, SUBM.055.0213 at 213.
- 51 Dr Mary McCaskill, Children's Hospital, Westmead hearing, 15 May 2008, transcript 2935.35-39.
- 52 Newborn & Paediatric Emergency Transport Service website, <http://www.nets.org.au> (6 October 2008).
- 53 NSW Health, *Emergency Obstetric and Neonatal Referrals – Policy*, PD2005_156 and NSW Health, *Emergency Paediatric Referrals – Policy*, PD2005_157.
- 54 Information provided during visit to the Children's Hospital, Westmead on 15 May 2008.
- 55 Professor Allan Isles, Paediatric Experts' Conference, 29 September 2008, transcript 129.29-35.
- 56 Confidential Children's Hospital, Westmead hearing, 15 May 2008, transcript 39.35-38.
- 57 Submission of Dr Padraic Grattan-Smith, 28 March 2008, SUBM.005.0535 at 536.
- 58 Dr Mary McCaskill, Children's Hospital, Westmead hearing, 15 May 2008, transcript 2934.36-2935.6.
- 59 Dr Mary Eleanor McCaskill, Children's Hospital, Westmead, 15 May 2008, transcript 2935.2-5.
- 60 Confidential Sydney Children's Hospital hearing, 19 May 2008, transcript 40.23.
- 61 Confidential Sydney Children's Hospital hearing, 19 May 2008, transcript 38.44-39.1.
- 62 Confidential Sydney Children's Hospital hearing, 19 May 2008, transcript 38.44-39.1.
- 63 Confidential Sydney Children's Hospital hearing, 19 May 2008, transcript 37.5-8.
- 64 Information received during visit to the Sydney Children's Hospital on 19 May 2008.
- 65 Confidential submission, 31 March 2008, SUBM.014.0253 at 253.
- 66 Confidential submission, 31 March 2008, SUBM.014.0253 at 254.
- 67 Australian College of Operating Room Nurses, *ACORN Standards – Perioperative Nursing 2006*, pp. 7-8, provided with submission of the Perioperative Managers Committee of the South Eastern Sydney Illawarra Area Health Service, 28 March 2008.
- 68 Dr Mary McCaskill, Children's Hospital, Westmead hearing, 15 May 2008, transcript 2938.36-42.
- 69 Submission of Roger Corbett, 31 March 2008, SUBM.003.0146 at 148.
- 70 Confidential submission, 7 May 2008, SUBM.041.0052 at 56, 57.
- 71 NSW Health, Clinical Practice Guidelines for Paediatric Care http://www.health.nsw.gov.au/public-health/clinical_policy/guidelines/index.html (11 September 2008)
- 72 Leanne Crittenden, John Hunter Hospital hearing, 12 May 2008, transcript 2763.1-8.
- 73 Leanne Crittenden, John Hunter Hospital hearing, 12 May 2008, transcript 2763.31 – 2764.1.
- 74 Submission of Bradley Ceeley and Fiona Wade, provided 15 May 2008, SUBM.037.0101 at 102.
- 75 Francis Dillon, Wagga Wagga hearing, 22 April 2008, transcript 1908.11.

-
- 76 Francis Dillon, Wagga Wagga hearing, 22 April 2008, transcript 1912.40.
- 77 Confidential Children's Hospital, Westmead hearing on 15 May 2008, transcript 4.12-20.
- 78 Letter attached to submission of Annette Wright, 14 April 2008, SUBM.055.0213 at 214.
- 79 Fiona Wade, Children's Hospital, Westmead hearing, 15 May 2008, transcript 2964.29-38.
- 80 Glenda Hooley, Tamworth hearing, 25 March 2008, transcript 861.14.
- 81 Matthew Hooley, Tamworth hearing, 25 March 2008, transcript 861.38.
- 82 Kylie Brett, Port Macquarie hearing, 28 March 2008, transcript 1088.31.
- 83 Kylie Brett, Port Macquarie hearing, 28 March 2008, transcript 1088.46.
- 84 Or vegetative state.
- 85 Fiona Wade, Children's Hospital, Westmead hearing, 15 May 2008, transcript 2970.24-2971.2.
- 86 Bradley Ceely, Children's Hospital, Westmead hearing, 15 May 2008, transcript 2969.10-41.
- 87 Information provided during visit to the Sydney Children's Hospital on 19 May 2008.
- 88 Bradley Ceely, Children's Hospital, Westmead hearing, 15 May 2008, transcript 2966.9-16.
- 89 Lyn Angelo Biviano, Children's Hospital, Westmead hearing, 15 May 2008, transcript 2984.26-28.
- 90 Letter attached to submission of Annette Wright, 14 April 2008, SUBM.055.0213.
- 91 Bradley Ceely, Children's Hospital, Westmead hearing, 15 May 2008, transcript 2961.42-2962.2; 2962.21-30; 2962.40-2963.11; 2963.34-41.
- 92 Bradley Ceely, Children's Hospital, Westmead hearing, 15 May 2008, transcript 2962.11-19.
- 93 Bradley Ceely, Children's Hospital, Westmead hearing, 15 May 2008, transcript 2967.40-45.
- 94 Bradley Ceely, Children's Hospital, Westmead hearing, 15 May 2008, transcript 2963.46-2964.5.
- 95 Bradley Ceely, Children's Hospital, Westmead hearing, 15 May 2008, transcript 2968.41-2969.6.
- 96 The Royal Children's Hospital, Melbourne website, http://www.rch.org.au/hacc/index.cfm?doc_id=1191 (6 October 2008).
- 97 Confidential submission, 1 May 2008, SUBM.077.0005.
- 98 Professor John Christodoulou, Children's Hospital, Westmead hearing, 15 May 2008, transcript 2943.10-13.
- 99 Confidential Children's Hospital, Westmead hearing, 15 May 2008, transcript 36.17.
- 100 Robyn Raine, Albury hearing, 23 April 2008, transcript 2051.24.
- 101 Professor John Christodoulou, Children's Hospital, Westmead, 15 May 2008, transcript 2943.35-2944.2.
- 102 Professor John Christodoulou, Children's Hospital, Westmead hearing, 15 May 2008, transcript 2944.42.
- 103 Professor John Christodoulou, Children's Hospital, Westmead hearing, 15 May 2008, transcript 2947.3-4.
- 104 Professor John Christodoulou, Children's Hospital, Westmead hearing, 15 May 2008, transcript 2944.6-11.
- 105 Dr Michael Paul Brydon, Sydney Children's Hospital hearing, 19 May 2008, transcript 3049.38.
- 106 Professor John Christodoulou, Children's Hospital, Westmead, 15 May 2008, transcript 2946.13-15.
- 107 Professor John Christodoulou, Children's Hospital, Westmead, 15 May 2008, transcript 2946.15-23.
- 108 Confidential submission, 31 March 2008, SUBM.014.0253 at 257.
- 109 Greater Metropolitan Clinical Taskforce, *GMCT/ICN Clinical Networks Summary Reports*, March 2008,

http://www.health.nsw.gov.au/resources/gmct/pdf/gmct_report_to_special_commission.pdf (14 November 2008), p. 42-43.

- 110 Bennett, D et al, "Smoothing the transition to adult care", (2005) 182(8) *Medical Journal of Australia* 373
- 111 Professor Leslie White, Sydney Children's Hospital hearing, 19 May 2008, transcript 3058.42-44.
- 112 Professor Leslie White, Sydney Children's Hospital hearing, 19 May 2008, transcript 3058.44-3059.2.
- 113 Professor Leslie White, Paediatric Experts Conference, 29 September 2008, transcript 96.40-41.
- 114 Information provided during visit to the Sydney Children's Hospital on 19 May 2008.
- 115 Submission of Professor Patricia Davidson, 27 March 2008, SUBM.004.0020 at 21.
- 116 Submission of Professor Patricia Davidson, 27 March 2008, SUBM.004.0020 at 21.
- 117 Professor Leslie White, Sydney Children's Hospital hearing, 19 May 2008, transcript 3059.21-34.
- 118 Confidential submission, 31 March 2008, SUBM.001.0001 at 2.
- 119 Leanne Crittenden, John Hunter Hospital hearing, 12 May 2008, transcript 2764.24-25; 31-33.
- 120 Professor Jonathan Gillis, Paediatric Experts Conference, 29 September 2008, transcript 49.31-39.
- 121 Report prepared by McKinsey and Company advising on the strategic organisation of tertiary paediatric services for Ireland, commissioned by Health Service Executive, Ireland, 1 February 2006, p. 15.
- 122 I am aware of the existence of guidelines prepared by NSW Health entitled, *Guidelines for Networking of Paediatric Services in NSW*, December 2002, and I acknowledge the effort that has been made in establishing these child health networks. My proposal builds on the efforts which have taken place to date.
- 123 Professor Allan Isles, Paediatric Experts' Conference, 29 September 2008, transcript 4.32-10.46.
- 124 Dr Jackie Andrews, Paediatric Experts Conference, 29 September 2008, transcript 83.3-6; Meeting with Professor Kim Oates, Faculty of Medicine, University of Sydney, 11 July 2008; Meeting with Dr Antonio Penna, Children's Hospital, Westmead, 31 July 2008; Confidential forum for CEOs and senior health executives, 16 October 2008, transcript 76.23.
- 125 Dr Ralph Hanson, Paediatric Experts Conference, 29 September 2008, transcript 107.11-14.
- 126 Professor Patricia Davidson, Paediatric Experts Conference, 29 September 2008, transcript 125.1-3; Dr Jackie Andrews, Paediatric Experts Conference, 29 September 2008, transcript 125.16-28; Dr Robyn Rosina, Paediatric Experts Conference, 29 September 2008, transcript 125.33-35.
- 127 Information provided during visit to St George Community Mental Health Service, 3 September 2008.
- 128 Submission of Richard Lynn, 27 March 2008, SUBM.026.0201 at 202.
- 129 Confidential forum for CEOs and senior health executives, 16 October 2008, transcript 70.38.
- 130 Dr Jackie Andrews, Paediatric Experts Conference, 29 September 2008, transcript 83.6-16.
- 131 Meeting with Roger Corbett, Chairman Advisory Board, Children's Hospital, Westmead, 6 May 2008; Confidential Sydney Children's Hospital hearing, 19 May 2008, transcript 25.38-45.
- 132 For example, confidential Children's Hospital, Westmead hearing, 15 May 2008, transcript 46.38-47.32.
- 133 ACT Health website, <http://www.health.act.gov.au/c/health?a=sp&pid=1210030709> (15 October 2008).

-
- ¹³⁴ Report prepared by McKinsey and Company advising on the strategic organisation of tertiary paediatric services for Ireland, commissioned by Health Service Executive, Ireland, 1 February 2006.
- ¹³⁵ Professor Allan Isles, Paediatric Experts' Conference, 29 September 2008, transcript 5.5-8.
- ¹³⁶ Professor Allan Isles, Paediatric Experts' Conference, 29 September 2008, transcript 5.13-26.
- ¹³⁷ Professor Allan Isles, Paediatric Experts' Conference, 29 September 2008, transcript 5.28-40.
- ¹³⁸ Professor Alan Isles, Paediatric Experts Conference, 29 September 2008, transcript 6.19-23.
- ¹³⁹ Professor Allan Isles, Paediatric Experts' Conference, 29 September 2008, transcript 9.45-10.1.
- ¹⁴⁰ Professor Allan Isles, Paediatric Experts' Conference, 29 September 2008, transcript 9.35-44.
- ¹⁴¹ Professor Allan Isles, Paediatric Experts' Conference, 29 September 2008, transcript 9.44-10.1.
- ¹⁴² Professor Alan Isles, Paediatric Experts' Conference, 29 September 2008, transcript 4.47-5.26.
- ¹⁴³ Dr Phillip Crowley, Paediatric Experts' Conference, 29 September 2008, transcript 17.43-45, 19.18-19.
- ¹⁴⁴ Dr Phillip Crowley, Paediatric Experts' Conference, 29 September 2008, transcript 21-12-32.
- ¹⁴⁵ Report prepared by McKinsey and Company advising on the strategic organization of tertiary paediatric services for Ireland, commissioned by Health Service Executive, Ireland, 1 February 2006.
- ¹⁴⁶ Dr Phillip Crowley, Paediatric Experts' Conference, 29 September 2008, transcript 22.4-13.
- ¹⁴⁷ Dr Phillip Crowley, Paediatric Experts' Conference, 29 September 2008, transcript 22.38-42.

6 Rural issues

Workforce distribution	128
Lack of workforce	128
Increases in supply.....	134
A distribution problem.....	134
The role of medical colleges and IMET	136
Incentive schemes	144
Differential pay and conditions	147
How can we attract health workers to rural and remote NSW?	152
Partnerships	154
Compulsory placements	156
Tele-medicine	156
Emergency Department.....	156
Obstetrics & gynaecology.....	157
Pharmacy	157
Mental health	157
Wider application of tele-medicine	159
Loss of medical services	159
Rationalising rural hospitals	159
Revitalising rural hospitals.....	159
Use of rural hospitals for non-tertiary surgery	160
Mental health in rural and remote areas	164
Lack of mental health staff.....	164
Emergency mental health in rural areas.....	164
Inpatient mental health units	167
Transport back to regional and rural areas after treatment	168
Financial assistance for travel expenses for rural and remote patients	170
A question of policy	170
IPTAAS	170
Accommodation	172

- 6.1 As I mentioned in Chapter 2, the sheer size of NSW, combined with the concentration of its population in Sydney and along the coastal fringe, presents considerable logistical challenges to the provision of health services across the State. Those difficulties are felt most keenly in regional, rural and remote NSW.
- 6.2 To some extent, the problems experienced in rural areas are the same as those in metropolitan areas. As a general observation, I would say that such problems, whilst shared, are exacerbated in rural areas by the tyranny of distance. I have dealt with such shared problems elsewhere in my report as follows:
- (a) loss of local maternity services in Chapter 4;
 - (b) difficulties encountered when transferring the care of complex paediatric patients to rural hospitals in Chapter 5;
 - (c) lack of access to electronic medical records and information technology in Chapter 14;
 - (d) problems with non-urgent patient transport, particularly for renal patients, in Chapter 27; and
 - (e) difficulties posed by the size of area health services following the most recent restructure in Chapter 31. I note in this regard the views of Professor Fragar that the amalgamation of the new area health services has led the loss of “rural thinking”:

“That cluster of health services that were very rural developed a common thinking and networking that you would have to work hard to recreate.”¹
- 6.3 Other problems are clearly felt most keenly in rural areas. In this chapter, I will discuss:
- (a) the lack of workforce, and how this might be remedied in terms of workforce distribution and by the use of tele-medicine;
 - (b) the loss of medical services in smaller rural hospitals, and how this might be revitalised;
 - (c) the treatment of mental illness in rural and remote areas; and
 - (d) transport problems, being the transfer of patients back to rural and remote areas after treatment, and financial assistance provided to patients to obtain treatment some distance from their homes.

Workforce distribution

Lack of workforce

- 6.4 In Chapter 7, 8 and 9, I have considered evidence of a shortage of health professionals. This evidence was most pronounced in respect of rural and remote areas of NSW.
- During my visit to Goulburn Hospital, I was told that attracting medical and nursing staff to work there is difficult.² A paediatrician has recently been recruited from South Africa, but that process took more than 8 months.³
 - During my visit to Bowral District Hospital I learnt that there is quite inadequate paediatric coverage in that region, with only 2 paediatricians available locally. An additional junior paediatrician and a training position for a paediatric registrar are needed to care for the 700 babies born at the hospital every year.⁴

- Similarly, during my visit to Wellington District Hospital, I was told that the hospital has difficulty attracting good staff.⁵ In particular, the hospital has no physiotherapist and it is having great trouble finding one.⁶ This has led to increased lengths of stay for Wellington's predominantly older patients.⁷
- A councillor of Dubbo City Council told me that recruitment and retention of medical staff in the Dubbo area is a major issue.⁸ There is an ageing group of doctors at Dubbo: within 2 years the number of doctors will be significantly reduced by retirements.⁹ There is also a lack of specialists, with the overall workload being distributed amongst a diminishing number of specialists.¹⁰ Specialists in Dubbo are called upon one night in 4, whereas in other centres within the Greater Western Area Health Service, such as Orange, the same specialists would be called one night in 12.¹¹ This makes it very difficult to recruit to the area.¹² Consequently, Dubbo relies heavily on temporary staff.¹³ The "fly in, fly out" specialists who staff the hospital are very expensive.¹⁴
- A VMO at Coolah Hospital (which is 1½ hours from Mudgee) made the following comments in relation to the shortage of doctors in rural areas:

"As you know, 30% of the country's population is away from metropolitan areas, and the services are not equally distributed to the rural areas. [W]e are very short of doctors and nurses ... and particularly rural Australia is becoming replaced (sic) by overseas trained doctors. I don't know how you are going to sustain these rural communities which are very much dependent on the doctor for their community survival, as well as their own survival."¹⁵

- The Director of Emergency Medicine and the nurse unit manager of the Emergency Department at Lismore Base Hospital told me that 5 full-time equivalent emergency specialist positions in the Department have not been recruited to.¹⁶
- A representative of General Surgeons Australia told me that a contraction of support services such as pathology, emergency medicine and general physicians makes surgical recruitment to rural areas very difficult.¹⁷ While 10.7% of general surgery occurs in rural hospitals, only 3.4% of provisional fellowship places are in rural hospitals.¹⁸
- A doctor at Tamworth Base Hospital told me that a lack of anaesthetists has a "domino" effect: it slows surgical recruitment and the upgrading of theatres, whilst also resulting in theatre nurses not being recruited.¹⁹ The witness also drew my attention to the fact that in the Tamworth area, there is no gastroenterologist for a population of over 400,000, while an anaesthetist who retired in mid-2007 was not expected to be replaced until January 2009.²⁰

6.5 Indeed, the Australian Medical Association and the Australian Salaried Medical Officers' Federation made the following comments about the pressing need for medical practitioners in rural and regional NSW:

"An AMA (NSW) survey of rural and regional members conducted in 2004 found rural and regional hospitals staffed with an ... ageing workforce, no succession planning and no clear commitment (to) attracting and retaining doctors to regional and rural NSW.

The AMA (NSW) survey was then repeated in 2006 ..., with an equally concerning set of results again highlighting an ageing medical workforce with 55% of respondents planning on retiring or reducing practice in the next 5 years. 82% of respondents indicated that their area had no arrangements for succession planning, adding to a grave and immediate threat to regional and rural practice."²¹

6.6 On the basis of the evidence given to the Inquiry and from my own observations when I toured through these areas, I am persuaded that there is a very serious workforce situation presently facing rural and remote areas of NSW.

6.7 Further, the inability to recruit permanent employees leads to a reliance on locums.

- The Director of Medical Services at Orange Base Hospital told me that senior supervision in the Emergency Department is being provided by locum staff.²² She observed that this was very expensive.²³
- Associate Professor Graeme Richardson of the University of NSW's Rural Clinical School at Wagga Wagga told me that the hospital has to rely on "fly-in" specialist services²⁴ and locums for intensive care and emergency medicine, at great expense to the hospital and the area health service.²⁵
- Dorrigo Multi-Purpose Service cannot always get locums on the weekends: it uses RAAF doctors from Newcastle and is exploring the option of nurse practitioners.²⁶ The local ambulance officer also provides assistance to the hospital if needed.²⁷

Page 130

6.8 An emergency physician who has worked as a locum for 17 years told me that locum agencies sometimes provide inexperienced staff to rural hospitals which are prepared to offer significant sums in the hope of securing the services of senior doctors, but will ultimately accept "whatever (they) can get".²⁸

6.9 I have explored the problems posed by a locum workforce in Chapter 7 (together with how these problems may be remedied).

General Practitioners

6.10 The problem with workforce distribution applies also to general practitioners, particularly those with the procedural skills who are needed in rural and remote areas.

6.11 As my Terms of Reference limit the ambit of this Inquiry to issues concerning the delivery of acute care services in NSW public hospitals, I will only consider the work performed by GPs in public hospitals. I have discussed in Chapter 7 the lack of generalist doctors being trained, and how this should be remedied, particularly given the pressing need for GPs in rural areas.

6.12 As the following table demonstrates, the ratio of GPs in NSW per 100,000 population in 2006-2007 was far less in rural and remote areas than in major cities.²⁹

Table 6.1 General practitioners: Full-time equivalent per 100,000 population, NSW, 2006-07

Major cities	106.9
Inner regional	82.0
Outer regional	67.7
Remote	86.9
Very remote	25.3
Total	99.1

Source: Medicare data

6.13 The existing workforce was generally described to me as aged in their 50s, with fewer younger recruits coming to country areas. In its 2007 publication, *NSW Rural General Practice Workforce Strategy: What Can We Do?*, the NSW Rural Doctors Network made the following observations in relation to the significant GP workforce shortage in rural NSW:

"The situation may be even more dire than anticipated. Until recently there has been a gradual increase each year in the number of GPs in practice in rural NSW however this trend has begun to flatten out. As at 30 June 2006, only 1,383 GPs (were) practising in rural NSW ... compared with 1,428 as at 30 June 2005. Retirements and departures from the GP workforce are also increasing. Thirty GPs ceased practising in rural NSW in the 6 months to 30 June 2006, compared with 38 departures in the whole of 2003. If a growth in the number of GPs practising in rural NSW cannot be sustained, the GP workforce shortage will be more significant than estimated.

In addition to this, the average age of GPs in NSW is rising. By 2002, the average age of GPs in NSW had risen to 50 years compared with an average age of 46.3 years in 1995. In the same period the average hours worked by GPs in NSW fell from 47.5 hours per week to 42.1 hours per week – a decrease of 5.4 hours per week.

... These factors in combination can be expected to significantly reduce the availability of GPs and GP services in rural NSW. Supporting existing GPs to remain in general practice must therefore be a high priority."³⁰

6.14 This was confirmed by evidence received during the course of this Inquiry.

- During my visit to Gulgong Hospital, I was informed that the hospital and town are regularly without a doctor: there is one VMO GP whom the hospital staff and town residents are very grateful to have.³¹
- When I visited Cobar, I was told that there were no permanent VMO GPs.³² Four locum GPs provide medical services for the town at the hospital.³³
- When I visited the Walgett Aboriginal Medical Service, I was told that attracting GPs is a problem.³⁴
- So too, during my visit to Wilcannia Health Service, I learnt that there are no GPs in town.³⁵ The Aboriginal Medical Service provides clinics 3 days a week.³⁶ I was told, however, that there are still "gaps" in the services offered.³⁷
- The Medical Director of the New England Critical Care Network told me that small rural hospitals have problems attracting GPs to the towns, and the GPs who do work there have to have the right kind of skills to deliver critical care in those areas.³⁸ He observed that those doctors need to maintain relevant skills in circumstances where they may not see a particular kind of case very often.³⁹ He also expressed concern that both the medical and nursing workforce are ageing.⁴⁰
- A GP obstetrician at Armidale (the population is about 25,000 people) told me that there are 6 GP obstetricians in that city, but all are in their late 50s or early 60s.⁴¹ He observed that sadly, there appear to be no young GP obstetricians coming into the system.⁴²
- A GP and VMO at Cooma Hospital told me that the age of rural VMOs is going up: there are no new doctors coming through to replace older ones, and there are very few rural doctors who practise obstetrics.⁴³
- A rural GP who performs obstetrics, anaesthetics and minor surgery at Muswellbrook District Hospital made the following comments about the ageing medical workforce in rural areas:

"You would note that the majority of rural doctors are over 50 and as they retire we are not having the younger doctors coming over. Basically they are not willing to commit themselves into rural practice because of the appalling working conditions both in terms of facilities

and rosters. They do not see a future in rural practice. Unless these issues are addressed I do not see the rural workforce being sustainable.”⁴⁴

- 6.15 In its submission to the Inquiry, the Rural Doctors Network reported a lack of support and encouragement for rural GPs to continue to provide procedural services, the availability of which is declining rapidly.⁴⁵ The Rural Doctors Network told me that although NSW Health has provided increased funding to support rural GPs (including practice incentive payments and enhanced primary care payments), GP VMOs receive no support or assistance to attend training or professional development courses in relation to the non-procedural aspects of their hospital work.⁴⁶ I was told that with increased funding for general practice (including practice incentive payments), it is not always viable for rural GPs to provide VMO services in any event.⁴⁷ Rather, it is more profitable for GPs to provide services in their private practices: in so doing, they avoid after-hours and on-call responsibilities.⁴⁸

Nurses & midwives

- 6.16 The problem with workforce distribution also applies nurses and midwives, particularly those with experience. Of particular concern was the lack of clinical nurse educators in rural areas, which I have discussed in Chapter 10 together with possible solutions. I heard of these examples:

- The Director of Clinical Care at Tamworth Base Hospital told me that the nursing workforce in small rural towns is ageing.⁴⁹ At the Emergency Department at Tamworth Base Hospital, nursing numbers are severely depleted, a situation he said was “dangerous”.⁵⁰ There is a lack of senior staff to supervise junior staff.⁵¹
- An enrolled nurse at Tamworth Base Hospital told me that many staff there are working double shifts, particularly in the Emergency Department and the Acute Care ward, due to staff shortages.⁵² On many shifts throughout the hospital, a second or third year registered nurse is often the most senior nurse on duty: these nurses feel very isolated and unprepared in the absence of guidance and support from experienced registered nurses.⁵³ Domestic staff, porters and security officers are often offered overtime shifts to act as “specials” for patients requiring visual monitoring at all times, such as dementia patients.⁵⁴ The witness told me that:

“[u]se of these staff in these situations is not optimal but if there is no other resource available it is often the only way managers can provide some assistance to staff caring for that patient.”⁵⁵

- The Acting Divisional Manager for Women’s, Children’s and Family Health at Gosford told me that there is a shortage of obstetricians and midwives on the Central Coast.⁵⁶ Problems with respect to the recruitment of midwives had emerged relatively recently due to an ageing workforce, a sharp increase in the birth rate over the preceding 4 to 5 years, and increasing workloads without increased staffing.⁵⁷
- I was informed that at Bowral District Hospital it is often difficult for the nurse unit manager to ensure that an adequate number of midwives is present in the maternity unit, and the midwifery cover is sometimes quite thin.⁵⁸
- A representative of the Coffs-Clarence Health Participation Forum submitted that the nursing workforce on the North Coast is ageing, and there is a “growing crisis looming” with the impending retirement of many nurses.⁵⁹ He told me that there were 37 nursing vacancies at Coffs Harbour Base Hospital, and that Bellinger River Hospital faced the loss of its obstetric services because of difficulties with respect to the recruitment and retention of a sufficient number of midwives.⁶⁰

- During my visit to Wilcannia Health Service I was told that there are insufficient nurses, and when the Service advertises positions, there is not a great amount of interest.⁶¹

6.17 A clinical nurse specialist in the operating theatres at Tamworth Base Hospital provided the following illustration of the difficulties faced when endeavouring to attract nurses to rural areas:

"[A]t the end of last year we had a pretty severe crisis in our maternity unit and I know the hospital advertised nationally, widely and nationally, for 3 months, and the amount of interest that they got back was absolutely zero. Let alone they couldn't attract anyone to the job, they got zero interest. I think that in itself actually tells you how hard it is."⁶²

Allied health & pharmacy

6.18 The lack of allied health professionals was also more acute in rural and remote areas. I heard that at Oberon they do not have a physiotherapist despite attempts to find one.⁶³ I also heard that more physiotherapists are required in Dorrigo,⁶⁴ and they have difficulty attracting allied health professionals to Quirindi.⁶⁵

6.19 The problems of recruitment to areas outside of the greater metropolitan areas also extended to larger regional centres such as Wagga Wagga where specialised allied health staff have to be flown in.⁶⁶

6.20 The evidence I heard is supported by Commonwealth Government data indicating that physiotherapist positions in inland towns are amongst the most difficult to fill.⁶⁷ The same is true for occupational therapists:

"[A] number of positions remained unfilled after several months of repeated advertising. Shortages were most evident in inland towns."⁶⁸

6.21 The under-representation of allied health in areas outside of the major metropolitan areas is not a new phenomenon. A study conducted in 2003, based on 2001 census data, revealed that the allied health workforce was under-represented in the rural and remote regions of NSW. It was found that whilst 29% of the population of NSW lives outside Sydney, only 21% of the allied health workforce practices outside the major metropolitan areas.⁶⁹

6.22 Whilst there are some financial incentives offered to allied health staff as part of their Award, this only applies to areas that are described as 'isolated' in the western part of the State. Most of the hospitals in rural NSW are not entitled to the isolation allowance. The allowance that is provided for allied health staff to work in these locations range from \$3.40 per week to \$6.80 per week.⁷⁰ These may be seen by metropolitan based workers to be pitifully small.

6.23 One solution that has been suggested to encourage allied health professionals to undertake practice outside the major centres is the right to private practice.⁷¹ NSW Health now has a policy that allows allied health professionals to engage in private practice to supplement their work in the public sector. The policy states:

"NSW Health believes the right of private practice scheme will help to promote the recruitment and retention of allied health staff and increase access to the range of services provided by allied health professionals to the community, especially in rural NSW (but not necessarily excluding non-rural locales)."⁷²

- 6.24 Whilst this may provide some financial and business incentive to assist allied health professionals to engage in practice in the rural or remote areas of NSW, it does not address the issue of professional isolation and lack of collegiate support and career advancement opportunities. To assist in this regard, various organisations have scholarship programs that provide financial support to allied health students undertaking country placements as part of their training, and for qualified allied health professionals to engage in professional development activities and ongoing education.⁷³

Increases in supply

- 6.25 The number of new doctors is expected to increase considerably from 2011, as I have discussed in Chapter 7.
- 6.26 In respect of nurses, there is some indication that the workforce shortage could be met with recent graduates. NSW Health told me that in 2008 there was an excess of newly graduated registered nurses, and some positions were not filled as they were not where graduates wanted to go.⁷⁴ I was told:

"They don't want to go to Brewarrina, they don't want to go to Bourke. They will wait. They have said to us, 'I will wait until there is a position next to where I live.'"⁷⁵

A distribution problem

- 6.27 The problem remains, at least in the short term, that in practically all hospitals outside metropolitan Sydney and the metropolitan areas of Newcastle and Wollongong, there are difficulties recruiting health professionals. These difficulties become greater the further from the Sydney Harbour it is that one travels.
- 6.28 The following table, provided by NSW Health,⁷⁶ sets out the full-time equivalent distribution of medical, nursing and allied health professionals as at June 2008, by area health service.

Table 6.2 Full-time equivalent health professionals by area health service, June 2008

Area health service	Medical		Nursing		Allied health	
	Number	% of total	Number	% of total	Number	% of total
Sydney South West	1,847.8	24.8	7,324.5	19.5	1,597.9	22.0
South Eastern Sydney Illawarra	1,525.9	20.5	6,467.7	17.2	1,411.7	19.5
Sydney West	1,303.3	17.5	5,571.6	14.8	1,144.9	15.8
Northern Sydney Central Coast	1,146.2	15.4	5,331.6	14.1	1,082.6	14.9
Hunter New England	888.4	11.9	4,876.6	13.0	876.8	12.1
North Coast	378.2	5.1	3,133	8.3	508	7.0
Greater Southern	171.3	2.3	2,543.6	6.8	353.9	4.9
Greater Western	176.9	2.4	2,380.6	6.3	282.1	3.9
Total	7,438	100	37,629.2	100	7,257.9	100

- 6.29 The following table, drawn from data from the Australian Bureau of Statistics' 2006 *Census of Population and Housing*, demonstrates the ratio of medical workers in NSW per 100,000 population in 2006, by remoteness of area.⁷⁷

Table 6.3 Medical workers: ratio per 100,000 population, NSW, 2006

Major cities	395
Inner regional	147
Outer regional	110
Remote	103
Very remote	0

Source: ABS 2006 Census of Population and Housing

- 6.30 The following table, drawn from data from the Australian Institute of Health and Welfare's *Nursing and Midwifery Labour Force Survey 2005*, indicates the ratio of nurses in NSW in 2005 per 100,000 population in various areas within NSW.⁷⁸ (Unlike GPs and medical workers generally, the NSW nursing workforce appears to be more evenly distributed across various geographical areas).

Table 6.4 Nurses: ratio per 100,000 population, NSW, 2005

Major cities	1,016
Inner regional	1,157
Outer regional	1,005
Remote	951
Very remote	1,122
Total	1,080

Source: AIHW, Nursing and Midwifery Labour Force Survey 2005

- 6.31 The following table, drawn from the Australian Bureau of Statistics' 2006 *Census of Population and Housing*, shows the ratio of NSW health workers (in total) per 100,000 population by remoteness of area in 2006.⁷⁹

Table 6.5 Total health workers: ratio per 100,000 population, NSW, 2006

Major cities	2,950
Inner regional	2,952
Outer regional	2,570
Remote	2,469
Very remote	1,534

Source: ABS 2006 Census of Population and Housing

- 6.32 The above data suggests that there are generally fewer doctors, nurses and other health professionals in rural and remote areas, and in outer metropolitan suburbs, a situation that was confirmed anecdotally during the Inquiry.
- During my visit to Cumberland Psychiatric Hospital I was told that staffing becomes more difficult "the further west you go".⁸⁰ Indeed, a clinical nurse specialist on the labour ward at Nepean Hospital told me that that unit cannot fill existing positions.⁸¹

- Whilst at Concord Hospital, I was informed that junior staff are allocated by “stream directors” based at the main hospital in the area health service.⁸² Accordingly, if there are staff shortages across the area, the main hospital retains its staff.⁸³ It was suggested that the idea of “areas” must be strengthened, as opposed to focussing on the notion of the “iconic” hospital.⁸⁴
- The Director of Medical Oncology at Wollongong Hospital made the following comments in relation to attracting oncologists to the Wollongong area:

“If you look at the figures, if you want to be an oncologist here, if you’re on a one in three roster, one week in every third week, you have to do an enormous patient load and you get paid less because there are fewer private patients out here. They can earn exactly the same amount of money, have a better lifestyle and live in the city.”⁸⁵

6.33 A variety of means are used to attract health professionals, including the assistance of the local council and charities.

- During my visit to Goulburn Hospital, the General Manager told me that the hospital is looking at instituting scholarship schemes to attract nursing staff, which will be funded by either local charities such as Rotary, or trusts.⁸⁶
- Whilst at Quirindi Hospital, I was told that over recent years the local council had attracted one GP to the town.⁸⁷
- The Head of the School of Rural Medicine at the University of New England described the system that has been implemented at Tamworth Base Hospital with a view to encouraging doctors to work in rural areas:

“[T]he future of quality care in the public health system is dependent on the quality of medical education, of medical students and of our junior medical officers. Within this region we have had a working model of a concept called vertical integration where we commence recruiting students from high school, trying to support them at their undergraduate level and then to continue to support them at their junior medical officer level, with a view that if you train in a rural area, you’re 2.5 times more likely to be retained in a rural area. I am an example of that. I was a junior medical officer in Tamworth in 1990.”⁸⁸

6.34 Such schemes must be encouraged if the problem of the inequitable workforce distribution is to be addressed.

The role of medical colleges and IMET

6.35 Several witnesses suggested to me that the problems with workforce distribution could be alleviated if the bodies responsible for allocating medical trainee positions ensured that regional, rural and remote hospitals received a fair allocation of trainees.

6.36 Many submissions to the Inquiry highlighted that a doctor’s early experiences in the medical workforce have a significant influence on his or her decisions about where to specialise in both a geographic and professional sense.⁸⁹ As I have just set out, I was told that there is evidence that rural-based students are 2.5 times more likely to be retained in a rural area.⁹⁰

Institute of Medical Education and Training

- 6.37 I have discussed the role of the Institute of Medical Education and Training (IMET) in Chapter 10.
- 6.38 IMET supports rural training in a number of ways including:⁹¹
- (a) the preferential rural recruitment scheme for internships;
 - (b) mandatory filling of rural positions in most training networks;
 - (c) advocacy for the development and funding of new positions in rural areas; and
 - (d) rural scholarships to encourage trainees to train in rural sites, for example, scholarships which are paid when the trainee stays longer than the minimum requirement of rural rotation.
- 6.39 One of the functions of IMET is to develop systems to enable distribution of medical training positions across NSW in a manner aligned with service needs. IMET does this through a state-wide computerised allocation system for interns which allocates each graduate to one of 15 training networks across NSW and the A.C.T based on the graduate's ranked preferences. The workforce distribution formula is related to service activities.⁹² All IMET training networks are linked to rural sites, so that trainees can obtain training in outer centres, not just in city hospitals. Interns who undertake a rural rotation may stay in the rural hospital for their first resident (PGY2) year.
- 6.40 In 2006, IMET established the Rural Preferential Recruitment Program in response to increasing demand from trainees, clinicians and health service managers for rural based internships for medical graduates. Until then, access to a rural internship in a specific location was generally through 'secondment' from a city hospital.
- 6.41 Under the Rural Preferential Recruitment Program, graduates with an interest in rural training apply directly to a range of rural hospitals accredited by IMET for pre-vocational training. This occurs before the main centralised intern allocation so that:
- unsuccessful applicants are still allocated to an intern placement in NSW through the main allocation process; and
 - rural hospitals with un-filled positions continue to receive other trainees on rotation within their training network.
- 6.42 In 2009, 10 rural hospitals will participate in this scheme.⁹³ So far, 54.5 full-time equivalent positions have been filled from applications from 77 graduates.
- 6.43 The universities play a significant role in the provision of educational resources to pre-vocational doctors. For example, I was told that Wagga Wagga Base Hospital relies significantly on the Rural Clinical School of the University of NSW for all educational resources⁹⁴.
- 6.44 The Inquiry received submissions that undergraduate training programs that aim to expose students to rural work are positive steps and ought be encouraged.⁹⁵ Anecdotally, it seems that a significant number of graduates who train in rural and regional areas return to the hospitals at which they trained as interns and residents.⁹⁶
- 6.45 The Inquiry received a submission from the Joint Medical Program offered by the University of Newcastle and the University of New England, in partnership with Hunter New England Area Health Service and Northern Sydney Central Coast Area Health Service, which has been developed specifically to link medical education with health workforce planning in rural and regional Australia. In that program, a major part of students' training takes place at Armidale and Tamworth rural referral Hospitals and

other sites within the New England area. It was submitted to the Inquiry that the Joint Medical Program is a stimulus to recruitment of medical staff to rural areas and that to achieve its goals, the program requires clinical placements in the public hospital system. I was told that lack of adequate supervision is one of the major barriers in rural areas to the provision of clinical placements.⁹⁷ I return to this below.

6.46 I received a number of suggestions as to how IMET could do more to enhance the rural medical workforce, including:

- (a) increasing the continuity of rural training, and taking initiatives to allow rural hospitals to develop stronger relationships with junior medical staff;
- (b) making Australian Medical Council graduates eligible to participate in the Rural Preferential Recruitment Program;
- (c) expanding the number of hospitals participating in the Rural Preferential Recruitment Program;
- (d) giving interns the option of doing a rural GP term instead of an emergency term.

6.47 On this latter suggestion, I note that IMET's recent discussion paper on mandatory emergency terms recommends the retention of emergency terms as a core requirement for general registration. It notes that the general consensus nationally is that an emergency term should be mandatory.⁹⁸ That paper also notes that PGY 1 trainees undertaking a rural GP term in South Australia in lieu of an emergency term appear now to be rotating into the Emergency Department because they were uncomfortable about not having exposure to emergency medicine.

6.48 The Inquiry received evidence about initiatives to expand the training settings available to prevocational doctors in rural centres, including the Prevocational General Practice Placement Program.⁹⁹ That program is for junior doctors who are undertaking hospital training but not yet enrolled in a specialty. Junior doctors remain employed by the public health system but rotate into a general practice for training. The program is managed by the Royal Australian College of General Practice and funded by the Commonwealth.

6.49 Wagga Base Hospital participates in the program, which, I was told, has engaged PGY2 doctors in ten-week rotations to Gundagai Medical Centre.¹⁰⁰ Early indications are that the program "is proving to be a great success and will help in rural doctor recruitment".¹⁰¹ However, I was told that an impediment to this program is that the Treasury Managed Fund has not accepted liability for doctors training in a private setting under that program and that the hospital is therefore required to bear the cost of professional indemnity insurance for participating junior doctors.¹⁰² I think that increasing reliance on programs such as this is inevitable and ought be encouraged through appropriate funding.

6.50 I was told by a specialist at Gosford Hospital that the development by IMET of training networks, such as for basic physician training, has resulted in:¹⁰³

"a dramatic improvement in the quality and the continuity of registrar cover, and I think that has impacted directly on patient care. I think that's been a wonderful change in the last few years, and the people who did that should be congratulated."

6.51 It was submitted however that peripheral hospitals, such as Wyong Hospital, should be allocated more experienced trainees than regional or metropolitan hospitals as they are generally areas with less supervision.¹⁰⁴ I generally agree with the thrust of this submission.

- 6.52 The Inquiry received a number of submissions that the medical workforce is not evenly or optimally distributed.¹⁰⁵ The Inquiry received submissions about the appropriate training system for junior medical officers to address rural workforce shortages.
- 6.53 Submissions received by the Inquiry state that the current approach, which consists of rotating junior staff around networks while leaving rural hospitals largely responsible for recruiting their own senior staff, is breeding a generation of junior doctors who have no loyalty to any point in the system and who have not experienced the collegiality that is such a powerful motivating factor for many current senior staff. They say that the rotation policy also fosters a culture of “fly in fly out” service delivery in rural centres to maximise financial return, as exemplified by people working as locums in the system at present.
- 6.54 One submission proposed that rather than the current network model for training the junior medical workforce, there should be a “hub and spoke” model with major medical centres taking responsibility for staffing specific regional and country centres.¹⁰⁶
- 6.55 The submission stated that, while a hub and spoke model may be paternalistic and seen as a threat to quality of care and autonomy, if the relationships are structured correctly, major centres would compete with each other in the services they provide to rural and regional centres to retain their referral base. It was submitted that it would be relatively easy to establish performance indicators to determine whether major centres were fulfilling their responsibilities. It was also submitted that it would be relatively easy to structure the contracts between “the spokes and the hub” in such a way that the rural and regional hospitals retained significant power in the relationships.¹⁰⁷
- 6.56 The Inquiry sought IMET’s response to these suggestions. IMET told me that it believes that networking represents the best model for balancing clinical service, training and trainees’ needs.¹⁰⁸ IMET conceded that under networked medical training, trainees spend less time in tertiary referral hospitals and more time in outer-metropolitan and rural hospitals, and that this has been lamented by senior clinicians in tertiary centres who feel they have lost a degree of control over the training and trainees.¹⁰⁹ IMET nevertheless considers that such disadvantages have been offset by substantial benefits to outer-metropolitan and rural areas, as well as providing benefits to trainees, who have indicated that the experience gained at smaller centres is an important stage in their training.¹¹⁰ IMET told me that the network model incorporates notions of consistency and loyalty through the “home hospital” concept.¹¹¹ IMET made the following further observations on the benefits of networked medical training:
- “(This system) is deliberately designed to give all sites within a network equal standing; and offer any site the opportunity to build a culture of training or professional support which would historically have been associated with the traditional tertiary referral hospitals or ‘hubs’. ... [E]ffective networked training allows all hospitals and communities to benefit from the advantages traditionally associated with tertiary referral centres.”¹¹²
- 6.57 As noted above, the Rural Preferential Recruitment Program is an exception to the general networking principle that applies to the allocation of PGY1 and PGY2 doctors in that it allows junior doctors to express an interest in undertaking a rotation in a particular rural hospital. I agree with submissions that this program ought be supported, expanded and encouraged.

Recommendation 12: *NSW Health should take immediate steps to enhance the supply of a skilled workforce of clinicians to rural areas by ways which include, at least:*

- (a) *Giving consideration to whether there is an available process by which there ought be made compulsory a rural training term for employed junior medical officers in their second and third year of employment with NSW Health, including reviewing which hospitals have the capacity to accept such trainees and what other steps are necessary to ensure the adequacy of the training of such junior medical officers undertaking a rural term;*
- (b) *Reviewing the existence of and developing, as required, employment packages with features which would attract and retain skilled staff to work in rural communities. This may include developing formalised partnership structures between metropolitan hospitals and rural hospitals which facilitate the transition of clinicians between the hospitals.*
- (c) *Developing education facilities and programs which ensure that clinicians working in the rural and remote areas of NSW are provided with adequate education and training.*

Colleges

- 6.58 As explained in Chapter 7, the Colleges accredit hospitals to host training positions for specialist trainees (or registrars). Some of them allocate registrars to accredited hospitals, while other positions are filled by the hospital through its own selection process. Submissions to the Inquiry argued that more training positions at both pre-vocational and registrar level are needed in rural hospitals.¹¹³ Other submissions said that while clinical placements for trainees exist, NSW Health has not provided funding to fill the vacancies. I discuss these issues below.
- 6.59 Some Colleges require their trainees to undertake rotations in rural and regional hospitals, and this was greeted with enthusiasm by local health professionals. The Inquiry was told, for example, that the Royal Australasian College of Surgeons and the Royal Australian and New Zealand College of Obstetricians and Gynaecologists both require trainees to undertake a rotation of 6 months in a rural hospital.¹¹⁴ I was told that the training is usually highly regarded because of the broad experience the clinician obtains.¹¹⁵
- 6.60 The Australasian College for Emergency Medicine also requires its trainees to undertake a rotation in a rural hospital. The Director of the Emergency Department at Liverpool Hospital suggested that mandatory rotations to rural hospitals in emergency medicine provide a benefit to the hospitals but are not sufficiently reliable in terms of continuity and volume to allow the hospitals to base their workforce planning around them.¹¹⁶ This is unsurprising given the shortage of advanced trainees in emergency medicine.
- 6.61 Some witnesses thought that the Colleges could do more to allocate trainee positions to regional and rural hospitals and support these trainees in their training programs, so that regional and rural hospitals have the benefit of specialist services and trainees are introduced to the possibilities of practising their speciality in such areas. Of course, as I have explained in Chapter 7, the ability of Colleges to place trainees in hospitals also depends on those placements being funded by NSW Health. I received many

- submissions from Colleges about the restrictions on their ability to do so because of funding issues.¹¹⁷
- 6.62 Many other submissions sought to highlight the need for more funded training places in rural hospitals. They said that trainees could obtain a wealth of experience in rural centres and that trainees provide an important enhancement to the level of service provided in those hospitals.¹¹⁸
- 6.63 One submission said that 4 years ago rural registrar positions were funded by NSW Health with the aim of improving exposure of trainees to rural practice and improving recruitment into rural areas once trainees were qualified.¹¹⁹ I was told that the Shoalhaven Hospital received one of these positions but NSW Health withdrew the funding after 2 years. I was informed that this happened before any assessment could be made of the effect of the initiative. Shoalhaven Hospital lost the position because the department could not maintain an anaesthetic registrar against other resource demands.¹²⁰
- 6.64 Although it is also a question of funding by NSW Health, it is apparent that some Colleges could do more to enhance the viability of the rural workforce by requiring their trainees to undertake a rural rotation. In my opinion, all trainees ought be required by their Colleges to undertake a rural attachment. It enhances the rural medical workforce, encourages trainees to work in rural centres on a more permanent basis and broadens the scope of the training received.
- 6.65 It was submitted to the Inquiry that specialist training should be decentralised.¹²¹ This would involve the specialist colleges recognising the benefits of substantial rural training to help solve workforce issues. I was told, for example, that in Wagga Wagga, it would be feasible to provide the bulk of training in general surgery, general medicine, orthopaedic surgery, radiology and anaesthetics. The trainee could then undertake a secondment at a metropolitan hospital to pick up training in the kind of cases not managed at Wagga Wagga. This is because it is said that:¹²²
- "[t]he standard that is required for a general surgeon in a regional referral hospital such as Wagga is certainly not that he has to be an expert in every particular area. That is as long as he is not perhaps a "cowboy" who goes beyond what would be expected, but rather refers things away that are appropriate to be dealt with by some particular subspecialist, which, is, of course, what happens now."
- 6.66 It is said that the service needs of rural communities are best served by people who are trained specifically for those service needs.¹²³
- 6.67 The decentralisation of specialist training is not something that my Inquiry can recommend as it also involves a question about the standards of specialist training. However, it is a matter which is worthy of investigation. However, I agree with the underlying proposition that the Colleges should do more to recognise the value of training in rural areas and to provide specific training to equip those trainees who are interested in rural practice with the necessary skills.
- 6.68 It was also submitted that where there are workforce shortages, one should consider reserving rural training places for trainees who come from regions or areas of workforce shortage.¹²⁴ This would encourage those trainees to return to regions where there are particular shortages of medical specialists. This makes good sense to me.
- 6.69 The Australian and New Zealand College of Anaesthetists made submissions about the need to meet workforce shortages in rural areas. It submitted to the Inquiry that the

security of funding for anaesthetic training positions is a major area of concern for the College, particularly in rural hospitals.¹²⁵ It is involved in a program through the Joint Consultative Committee on Anaesthesia that trains and supports GPs to provide anaesthesia services in rural and remote areas. However, it would also like to see a new way forward in developing a more sustainable approach to the provision of specialist anaesthesia services in rural and remote areas. Its suggestions included:

- promoting the active engagement of rural anaesthetists and rural hospitals;
- working with other Colleges and the Australian Society of Anaesthetists;
- introducing local incentives to attract senior trainees and junior specialists to practice in rural areas, including for 3 month periods, to help ensure the viability of specialist anaesthesia practice in those areas;
- forming collegial relationships between rural hospitals and metropolitan teaching hospitals with the aim of supporting rural hospitals: this would involve rural specialists having access to short attachments to metropolitan hospitals for revision, the provision by metropolitan hospitals of advice and support to rural hospitals for quality assurance programs, and visits by tertiary hospital specialists to rural hospitals.

- 6.70 The latter suggestion echoes the proposal referred to above about linking metropolitan and rural hospitals for the purposes of staffing and service provision. In my view, these proposals have a great deal of merit. I consider that the practitioners in metropolitan hospitals should have a responsibility to support their rural counterparts in various ways. I have made recommendations elsewhere in this chapter to ensure that this occurs.
- 6.71 The Australian and New Zealand College of Anaesthetists also submitted that in rural areas there is a tendency for hospitals to view trainees (that is, registrars) as substitute specialist workforce. In Chapter 13, I discuss some of the issues faced by registrars in rural centres. While in general registrars work with increasing autonomy as they progress through their training courses, it needs to be recognised that they are trainees themselves and require adequate supervision.
- 6.72 This leads me to one of the most vexing issues when it comes to solving the crisis in medical workforce in rural areas. That is, how to ensure appropriate levels of specialist staff. Obviously, if training positions in rural areas are to be boosted, then ensuring appropriate levels of specialist staff to provide supervision becomes vital.
- 6.73 The Australian Medical Association (NSW) and the Australian Salaried Medical Officers Federation submitted to the Inquiry that this is a major area of concern.¹²⁶ A survey of rural and regional members in 2006 indicated that 55% of respondents were planning on retiring or reducing practice within the next 5 years. 82% of respondents indicated that their area had no arrangements for succession planning. The Australian Medical Association (NSW) told me that there is presently no clear commitment with respect to attracting (and retaining) doctors to regional and rural NSW. Without senior doctors, there is little hope of improving the number of clinical placements for junior doctors.
- 6.74 There are a number of issues affecting the level of specialist staffing in rural areas. Firstly, I was told that one of the difficulties in recruiting young specialists to rural postings is the safe hours principle and the increasingly part-time nature of the workforce.¹²⁷ Limited staffing levels in rural areas means doctors have more onerous commitments to carry out on-call work, which makes work in rural areas unattractive. A lack of access to private billings also reportedly affects recruitment capabilities at senior levels.¹²⁸ Additionally, I was told that nowadays doctors complete specialist training programs too specialised for country practice. Solutions to these problems have been the introduction of “area of need” doctors and the use of “fly in fly out” locums.

- 6.75 The Inquiry received submissions about the problems which can occur when junior registrars are rotated to rural hospitals. It was submitted that junior registrars should not necessarily rotate to rural hospitals because those hospitals generally have less provision for appropriate supervision than the metropolitan hospitals.¹²⁹ It was also said that senior registrars who are approaching the completion of their training are more likely to seriously consider the benefits of long-term rural practice.¹³⁰
- 6.76 Some submissions put forward solutions to these problems. Solutions include:
- having more “area of need” positions;
 - abolishing HECS if junior doctors agree to work in the country: although this does not immediately improve the levels of specialist staffing in rural areas, it is said that this would encourage doctors to take up rural practice permanently;¹³¹
 - developing training packages for those who express an interest in rural practice to encourage trainees to work rurally and make long-term commitments to such practice; and
 - developing 8-year appointments for staff specialists requiring the doctor to spend 4 years in a rural hospital and 4 years in a metropolitan hospital (for example, Dubbo Base Hospital and Royal Prince Alfred Hospital) with an option at the end of this period to take up a position in either hospital.¹³²
- 6.77 I was told that 2 issues that need to be addressed in any proposed solution for attracting specialists to rural practice¹³³ are (a) options for returning to city or regional practice after a period of time in rural practice, and (b) assuring doctors that there is adequate cover for them for taking annual leave and other types of leave and limiting their on-call work obligations.
- 6.78 I have addressed (b) in my discussion of the locum workforce and the significant reforms to that system which need to be made.
- 6.79 As to (a), one solution is to introduce packages that require staff specialists to work partly in rural centres and partly in other areas. A proposal which merits close consideration is the development of employment packages for staff specialists which require staff specialists to spend a proportion of time in a rural hospital and a proportion of time in a metropolitan hospital, with a guaranteed place in a metropolitan hospital at the end of the contractual period. Those packages would include appropriate incentives to attract staff specialists to rural practice.
- 6.80 For its part, NSW Health has released a ‘country careers’ website to enhance recruitment in rural areas.¹³⁴ It outlines some benefits available to doctors who relocate to rural areas, such as a relocation allowance. However, in my view the lack of detail about initiatives on that website demonstrates that there is currently no concerted program to solve the medical workforce crisis in rural areas.

Other rural training schemes

- 6.81 Other rural hospitals have set up their own training schemes, which in my view should be supported and replicated elsewhere. Dr French of Armidale Hospital gave evidence about a training scheme set up for the purposes of increasing the availability of GP proceduralists in NSW and increasing the basic surgical expertise in rural areas.¹³⁵ The scheme takes up to 30 trainees each year who are generally fellows of the Australian College of General Practice who need specific skills to practise in rural areas. The training aims to teach trainees what they can reasonably manage in their local area and what should be referred. The trainee is required first to undertake an intensive course

in anatomy. The course then covers pre-operative, operative and post-operative training.

- 6.82 This has been successful in training doctors who stay in rural areas. Dr French requested further investment in post-graduate training in Armidale as they are presently only allocated 3 hours teaching time to provide weekly tutorials. I was told that the scheme has been successful in training doctors to stay in rural areas. Under the scheme, Armidale Rural Referral has taken 4 trainees in surgery, 2 in obstetrics and 3 in anaesthetics (as at March 2008). The number of participants has increased, however they have a disparate range of skill levels and training needs, making it difficult to tutor all trainees effectively.¹³⁶ I was told that there is a need to subdivide the group to achieve optimal tuition and also a need for dedicated teaching areas.
- 6.83 The benefits of this scheme are that it encourages a permanent base of resident rural practitioners who stay long term and it decreases the reliance on itinerant staff in areas of workforce shortage. I was told that it provides a role model for medical students who see the training provided to doctors who proceed to work in rural areas.

Incentive schemes

- 6.84 During the Inquiry, witnesses and NSW Health told me about a number of rural workforce initiatives that are aimed at enticing health professionals to rural areas and other locations that are perceived to be less attractive.
- 6.85 One such scheme involves recruitment to what were described to me as “area of need” positions.¹³⁷ As I understand it, the Area of Need Program enables the recruitment of suitably qualified overseas-trained doctors into declared “area of need” positions on a temporary basis, while efforts continue to attract medical practitioners with general registration on a permanent basis.¹³⁸ NSW Health has developed a number of principles applying to the program. In particular, in determining the reasons why a medical position is required under the Area of Need Program, applicant organisations must provide documented evidence to demonstrate that genuine attempts have been made to test the Australian labour market.¹³⁹ Area of need positions include specialists, non-specialists and GPs.¹⁴⁰ I understand that of 681 such positions, 267 had been filled as at 4 April 2008.¹⁴¹
- 6.86 NSW Health also told me that it had recently entered a 4-year arrangement with the Australian Medical Association, involving the introduction of a rural incentive package as a means of enhancing the conditions of VMOs who work in base hospitals.¹⁴² This is in addition to the “Rural Doctors Settlement Package”, which I have been told is characterised by enhanced conditions for GP VMOs working in what were described to me as “really tiny hospitals”.¹⁴³
- 6.87 Those conditions are set out in NSW Health’s *Policy Directive – VMOs in Rural Doctors’ Settlement Package Hospitals Indexation of Fees from 1 August 2007*,¹⁴⁴ which provides a variety of flat fees for on-call attendances and after hours consultations, amongst other allowances.¹⁴⁵ Under the Settlement Package, VMOs are also entitled to payments in certain circumstances where attendance at meetings is required by the area health service.¹⁴⁶
- 6.88 I understand that the Remote Areas Attraction and Retention Pilot also applies to certain medical positions in rural and remote areas.
- 6.89 The Medical Director of the Eastern Suburbs Medical Service told me about a Federal Government initiative known as the Approved Medical Deputising Service Scheme, which gives labour force privileges to a group of medical graduates who are not able to

access a Medicare provider number.¹⁴⁷ By way of illustration, he said that if a doctor works for an after-hours medical service, under the scheme he or she can access a provider number in circumstances where they would not otherwise qualify for one.¹⁴⁸ He stated:

"A portion of the labour force that otherwise wouldn't be able to work is able to work in a controlled, quality-driven after-hours Approved Medical Deputising Service. So it is within that program that I am able to draw upon some staff."¹⁴⁹

6.90 The Director of Medical Services at Tamworth Base Hospital told me that Tamworth uses a rural preferential scheme for intern recruitment whereby junior doctors or medical students who ask for a place at a rural hospital can get the job straight away and then drop out of the mainstream recruitment process.¹⁵⁰ He told me that this is a way of attracting people who want to be in rural hospitals, and retaining them for the long-term.¹⁵¹ He said that there are 2 separate schemes: one pays money to the student before he or she graduates, and the other reduces the student's HECS debt.¹⁵² I understand that the scheme bonds the student to rural services for 2 or 5 years.¹⁵³

Page 145

6.91 One problem associated with incentive schemes is the ill-feeling that may be engendered in local health professionals who do not receive the benefits of these packages. Certainly, a doctor at Bourke complained to me about the lack of support provided to local doctors:

"I am probably the last person in NSW to actually buy a practice. I had my own house in town here, and the level of support that I get now is minimal because I am here, I am seen to be here and it's 'just get on with it'.

Even the shire council, I asked them for support in a very minor way, after actually purchasing my own home, and no. It's somehow easier to roll out the red carpet every couple of years and attract someone from overseas with perhaps lesser skills than it is to keep the people you have here happy."¹⁵⁴

Nursing Recruitment and Retention Initiatives

6.92 The Inquiry received evidence that the *Remote Areas Attraction and Retention Pilot 2006/2009* (referred to by some witnesses as the "Recruit & Retain" package) had been extremely successful in attracting nurses to certain remote areas. Developed by the NSW Department Premier and Cabinet, the Recruit and Retain Pilot applies to a number of participating agencies, including the Attorney General's Department, the Department of Corrective Services, the Department of Community Services and Greater Western Area Health Service.¹⁵⁵ The Pilot involves 2 packages: the attraction package and the retention package.¹⁵⁶

6.93 The attraction package applies to people who re-locate to Brewarrina, Bourke, Walgett or Wilcannia under the Pilot, where the position has been unsuccessfully advertised for at least 6 months.¹⁵⁷ The attraction package includes:

- a \$5,000 (gross) cash bonus at the completion of each year of service;
- a house/unit provided by the employer for 20% of market rent, or a living away from home allowance (for private rental costs) of between \$12,000 to \$16,000 per annum;
- a notebook computer and internet connection, which becomes the employees' personal property after 6 months service in the Pilot;

- 5 days professional development on work-related training, in addition to any normal Award entitlements; and
 - travel expenses in the case of family illness or death.¹⁵⁸
- 6.94 At the end of the Pilot, permanent public sector staff are able to return to a position in their original location at their substantive grade; alternatively, they may be able to nominate to accept the Pilot position permanently, or elect to transfer to a location of their choice within their home agency, provided there is a vacancy at their substantive grade.¹⁵⁹
- 6.95 The retention package applies to employees who are working at one of the Pilot towns who meet the following criteria:
- they are working in a similar role to one that is entitled to the attraction package;
 - they have re-located to one of the Pilot towns in the last 3 years; and
 - they work for one of the participating agencies.¹⁶⁰
- 6.96 Under the retention package, employees are entitled to almost all of the above benefits of the attraction package, with the exception of housing and rent assistance.¹⁶¹
- 6.97 Unless otherwise determined by the Director-General, secondments and fixed-term employment under the Pilot are for periods of up to 3 years.¹⁶²
- 6.98 I was told that although the Pilot has had some (minimal) success in the Greater Western Area Health Service, it has also had a negative effect on the people who are already employed in those areas (see my discussion elsewhere).¹⁶³
- 6.99 The Health Service Manager at Bourke Hospital told me that the Recruit & Retain program has been very beneficial for Bourke, and they have recruited 10 people since the program's commencement in 2006.¹⁶⁴ Those recruits included 2 mental health workers, a nurse unit manager, a sexual health nurse, a women's health nurse, an enrolled nurse, 2 registered nurses, one registered midwife and a primary health care nurse.¹⁶⁵ The witness told me that some people resigned from the program after 6 months or a year.¹⁶⁶ She nevertheless said that she regards the incentives offered by the program as excellent.¹⁶⁷ She told me that the incentive package had enabled the hospital to retain 14 other staff.¹⁶⁸ She also said that the program's incentives are really needed to recruit people to Bourke.¹⁶⁹
- 6.100 She told me that people who have been recruited under the program have been very skilled and worked really well at fitting in,¹⁷⁰ and further observed:
- "I personally don't know what, as a manager, I would have done if we did not have that program. Our costs would have been even more as we would have had to be bringing in agency staff, if we could get the agency staff. Agency staff are not just there for us to pick off the tree."¹⁷¹
- 6.101 A nurse at Bourke Hospital made the following comments in relation to the Recruit & Retain Pilot:
- "It is a valuable package because with our position applications when that package was publicised, I'm not saying they all came to fruition, but the enquiries increased incredibly because of the opportunity."¹⁷²
- 6.102 The Acting Health Service Manager at Walgett Health Service told me that previously, her main concern was the recruitment of nursing staff.¹⁷³ However, she told me that the Recruit and Retain program had largely solved that problem.¹⁷⁴ The recruitment

situation is now good: the Pilot has worked well and attracted additional staff.¹⁷⁵ I was informed that while the program was set up by the Premier's Department, however, it is funded out of the Walgett Health Service's budget.¹⁷⁶ I was told that the program is slightly cheaper than paying fees for agency nurses, and a number of nurses have been successfully recruited because of it.¹⁷⁷

- 6.103 As adverted to above, a downside of the program is the resentment engendered in local nurses who have already worked in the remote area for some time. Indeed, the Acting Health Service Manager at Walgett told me that the program is clearly causing dissatisfaction and resentment amongst existing staff, as no incentives have been provided to them.¹⁷⁸ She said that a further problem with the program was demonstrated by the fact that a nurse working at Walgett Aboriginal Medical Service moved to Walgett Health Service in order to benefit from the program.¹⁷⁹
- 6.104 The Health Service Manager at Bourke District Hospital agreed that the program left a "big gap" insofar as people who had been locally employed for a long time did not receive any incentive package or reward in recognition of their work.¹⁸⁰ A nurse at Bourke Hospital aptly summed up this problem by telling me that the program does not support the nurses who have "stuck it out over the years".¹⁸¹
- 6.105 Nonetheless, in my view, Recruit & Retain (and similar programs) should be continued and expanded to other remote hospitals as they were, to my observation, clearly embraced by the hospitals and nurses working in hospitals where the pilot schemes have been running. Consideration ought to be given to whether retention reward packages could be aligned to reward those who have stayed on for many years.

Differential pay and conditions

- 6.106 Many witnesses suggested that financial incentives should be offered to health professionals to work in hospitals which are considered less attractive, or where there are real problems recruiting otherwise.

Allowances payable to health professionals under Awards

- 6.107 I understand that "climatic" and "isolation" allowances are provided for in the *Public Health Systems Nurses and Midwives (State) Award* ("the Nurses Award"), the *Operational Ambulance Officers (State) Award*, the *Operational Managers (State) Award*, the *Health Employees Conditions of Employment (State) Award*, the *Public Hospital Professional and Association State Conditions of Employment (State) Award*, the *Public Health Services Employees Skilled Trade (State) Award*, and the *Ambulance Service of NSW Administrative and Clerical (State) Award*, covering a range of employees in NSW public hospitals.¹⁸²
- 6.108 These allowances appear to me to be far from generous. For instance, under the Nurses Award the climatic/isolation allowance for nurses working in the west of NSW is only \$3.60 per week, while the same weekly allowance for those working in far western NSW is \$7.09 per week.¹⁸³ It is not hard to understand why some people might regard such allowances as offering little by way of incentive to work in certain rural and remote areas.
- 6.109 I note that there is provision for relocation expenses in the *Public Hospital Medical Officers (State) Award*, which provides that staff employed in a metropolitan facility who obtain a permanent position within the public health system in a country location are entitled to reimbursement for the costs incurred by the staff member in respect of removal of furniture and effects and conveyancing for the purchase of a residence.¹⁸⁴ I

have been told that 50% of costs incurred are refunded at the time the appointment is taken up, and a further 25% of the costs incurred are refunded after one year's service at the country location; after 2 years service, the remaining 25% of the re-location costs are refunded.¹⁸⁵

- 6.110 Similarly, I understand that under the *Health Managers (State) Award*, relevant staff members with 12 months continuous service at another health service are entitled to reimbursement of the *actual* costs incurred in the transportation of the staff member and their family, and the expenses reasonably incurred in conveying their furniture/effects from their last place of residence to the town in the health service to which they are appointed.¹⁸⁶

Differential pay and other benefits

- 6.111 Many witnesses thought that differential pay should be used to attract staff to some areas. For instance, an obstetrician at Liverpool Hospital told me that the awards do have a number of features which can assist in the recruitment and retention of staff.¹⁸⁷ He said that there are allowances of 5-10% at the discretion of general managers and the department, and there is also flexibility in terms of working hours.¹⁸⁸
- 6.112 A gastroenterologist at Liverpool Hospital told me that in her view, doctors in out-of-metropolitan hospitals such as Campbelltown and Liverpool should have higher remuneration to reflect the time it takes them to travel to work, and greater workloads.¹⁸⁹
- 6.113 Indeed, the Chair of the Medical Staff Council at Liverpool Hospital informed me that the Council conducted a questionnaire in respect of which 36 of 40 respondents said that they believed that preferential remuneration and conditions would help recruitment and retention of medical staff in outer-metropolitan Sydney.¹⁹⁰
- 6.114 A VMO radiologist at Wagga Wagga Base Hospital told me that in his view, recruitment to areas of workforce shortage would be boosted by a loading of the remuneration of locally-resident doctors.¹⁹¹
- 6.115 The Clinical Stream Director of Population Health and Primary Health Care for South Eastern Sydney Illawarra Area Health Service supported the idea of differentiated appointments between metropolitan and regional/rural hospitals.¹⁹² In this context, she stated:

"It is actually often quite difficult to attract people to work in a regional setting if they have a very high requirement and a very high patient load. Compared with a city practice where you might be on call a quarter of the time and have half the patient load, it becomes very difficult to appoint people on the same monetary scale. Why would you choose to go somewhere where you will have to work twice as hard?"¹⁹³

- 6.116 The Chair of the Medical Staff Council at Shoalhaven District Memorial Hospital also directed my attention to the problem of the "lack of adequate differential remuneration ... for regional medical officers (as compared to their) metropolitan (counterparts)".¹⁹⁴
- 6.117 A doctor at Concord Hospital made the following statements in relation to differential pay:

"There has to be a recognition that there are areas where it is difficult to recruit or retain staff. Some areas of health care are less attractive to health professionals and administrators than others. This sometimes reflects the geographical bias but also large

patient loads. The solution, I feel, probably in this context, is that one needs to consider a differential salary structure to make unpopular placements more attractive."¹⁹⁵

- 6.118 A representative of the Hunter New England Area Health Service Allied Health Committee made the following comments in relation to incentives that could be offered to attract health workers to hard-to-fill areas:

"There is a critical issue regarding recruitment in many rural services - some positions have been vacant for years, or have been abolished because they have been vacant for so long. This obviously restricts the type and range of clinical services that can be supported locally eg orthopaedic services requiring post-surgery physiotherapy intervention. This can lead to longer (length of stay) in locations with these resources [placing further strains on this service] and significant disruption to clients who could be treated locally if a physiotherapy service was available.

More innovative and valued recruitment and retention incentive packages (are needed) especially for rural areas and difficult to fill positions. The incentives available need to be funded, need to be substantial and need to include funded access to professional supports [video conferencing costs for supervision, costs covered for supervision support, travel costs covered as well as provision for leave and payment of associated fees for professional development activities], relocation expenses covered, short-term accommodation support funded etc. Incentives need to be greater - the more rural and remote positions and/or more difficult to fill positions (should) attract higher level incentives."¹⁹⁶

- 6.119 A representative of the Royal College of Pathologists Australasia made the following comments in relation to the suitability of employment packages offered to prospective rural employees:

"Practice in the country has less appeal to specialists as it is often in isolated environments with less peer and institutional support than in city hospitals, relatively unattractive salary packages [including remuneration and travel allowances], increased proportion of on-call duties and lack of availability of locum cover for absences such as annual or conference leave.

... With trends to increasing urbanisation worldwide, it is a challenge to persuade current practitioners or new Fellows to take up an unknown future in the remote or rural environment with a 'standard' employment package designed for metropolitan practice. If market forces are to operate, then remuneration and conditions of employment will need to recognise and take the additional factors involved in practice in these areas into account."¹⁹⁷

- 6.120 A radiologist at Wagga Wagga agreed that as a means of recognising the differences between the work required of a VMO or staff specialist in a regional or rural centre as opposed to the work required of such position-holders in large tertiary referral hospitals, NSW Health should provide differential remuneration packages:

"Why is it that NSW Health offers only a token difference in remuneration and conditions between a VMO at a major tertiary centre where on-call is far less onerous [because it is spread over a large number of VMOs and

staff specialists and because there are the resident and trainee support staff] than for a VMO at a regional or rural hospital, where the VMO may be on a 1-in-1 roster day and night for obstetrics or anaesthetics, usually without any trainee or even junior resident staff backup. The day and night aspect is important, because while in the tertiary centre there are usually enough medical staff to cover day-time/in-hours work, in a regional or rural centre a VMO may often have to attend the hospital during his (or her) normal consulting hours for emergencies, but the fixed costs of his (or her) private practice are not separately compensated/remunerated. How is that equitable?"¹⁹⁸

Other inducements

- 6.121 For some health professionals, other inducements were suggested such as more flexible working hours, administrative support or educational opportunities.
- 6.122 A clinical nurse specialist in the operating theatres at Tamworth Base Hospital told me that in his view, a flexible roster is essential in order to attract nurses back to the workforce or to rural areas.¹⁹⁹ He also thought that having more clinical nurse specialists in rural areas would attract new graduates.²⁰⁰ In this context, he observed:
- "The new graduates need a very strong mentoring program in their first year to keep their feet well and truly on the ground and help them through their first transitional year."²⁰¹
- 6.123 The Clinical Stream Director of Population Health and Primary Health Care for South Eastern Sydney Illawarra Area Health Service suggested that incentives for people to work in regional areas should include money, educational opportunities and greater administrative support.²⁰²
- 6.124 The Director of Aged Care and Rehabilitation, Eastern Cluster of Greater Western Area Health Service, told me that there should be an incentive scheme to attract young registrars to rural areas.²⁰³ In this regard, she stated:
- "Different incentives work in different stages of people's lives. ... [M]oney when you're 50 or 60 doesn't do it, you want quality of life. Money when you are 20 and 30, and trying to set up your house and set yourself up, I think money does help."²⁰⁴
- 6.125 Indeed, a former Deputy Director-General of NSW Health also told me that money does not appear to be the solution to get specialists to go to country areas: the incomes of specialists are higher outside the Sydney area (as there are fewer competitors), and living costs are lower.²⁰⁵
- 6.126 A VMO at Mudgee Hospital made the following comments in relation to measures that might be implemented to recruit and retain doctors in rural areas:
- "I think the solution ... is (to not just) recruit an individual doctor but try and recruit a whole doctor's family. One of the big problems with keeping people in town is making sure that their families are happy as well, their spouses in particular, and children, education, and all that kind of stuff. If there is a bigger package involved, I think the people would be more willing to stay."²⁰⁶
- 6.127 The Director of Anaesthesia at Tamworth Base Hospital told me that the hospital is no longer able to offer provisional fellowships, under which doctors in their 5th year of

anaesthetic training could be offered employment with VMO status and given a provider number under the *Health Insurance Act*.²⁰⁷ She told me that this previously provided rural hospitals with an advantage in terms of attracting students in their 5th year of anaesthetic training.²⁰⁸ In this context, she observed:

"[T]he 1996 amendment to the *Health Insurance Act* has stopped this because post-1996 no university graduate can get a provider number unless their specialist course is completed. We can only offer provisional fellow(ship) jobs on an absolute par with the city and so the provisional fellow will often say, 'why should I come to the country?' In the past we've been able to say we can actually pay you on a different rate and we can give you a better mix because you can actually charge the private patients. You can't do that now. They have to be staff anaesthetists ..."²⁰⁹

- 6.128 She told me that having final year anaesthetic students at the hospital generally resulted in the provisional fellows saying:

"Well, I'll just stay for an extra year",

and they would then use their knowledge in the country area.²¹⁰

- 6.129 One rural GP/VMO suggested that NSW Health establish a GP obstetrician mentoring program for young doctors in small rural areas with functioning maternity units, under which an experienced GP obstetrician would be paid to supervise doctors undertaking the obstetric diploma during their first 6 months in rural practice.²¹¹

- 6.130 Other witnesses suggested that, for specialists, a guarantee that they would not be disadvantaged in applying for jobs in the city after a rural posting would assist. For instance, the Director of Anaesthesia at Tamworth Base Hospital discussed the problems with competing with metropolitan hospitals for anaesthetic registrars, stating:

"[A] lot of people are very happy to bring their skills and work in the country for a short period of time, as long as they know they can get back into the jobs they want to in the city".²¹²

- 6.131 She suggested that a scheme be implemented whereby specialist anaesthetists who have worked in the country for more than a year are given preference for jobs in the city.²¹³
- 6.132 During my meeting with the Deans of the Medicine faculties of some NSW universities, I was told about a proposal put to NSW Health for an 8-year appointment for staff specialists who would work 4 years in a rural hospital and 4 years in a metropolitan hospital, with the option of returning to a guaranteed place in the metropolitan hospital at the conclusion of the period of appointment.²¹⁴ I was told that NSW Health was not interested in this proposal, but that in order to get people to go to rural areas and stay there, they need to be offered "a way out".²¹⁵ This type of proposal sounds as though it may be sensible, but I am not certain quite how effective or practicable.

Housing for rural health professionals

- 6.133 As adverted to above, housing appears to be a real problem in rural and remote areas. During the Inquiry, accommodation (amongst other things) was certainly cited as a significant recruitment and retention issue. I have been told that no Awards that apply to staff in the NSW public health system provide for housing allowances.²¹⁶

- 6.134 During my visit to Walgett Aboriginal Medical Service, I was informed that attracting staff and GPs was a problem because of issues such as a lack of accommodation and available work for spouses, and limited entertainment such as cinemas.²¹⁷
- 6.135 Whilst at Broken Hill Hospital, I was told that having staff accommodation has been a significant advantage for the hospital: it provides a very social environment, resulting in people staying longer or coming back several times.²¹⁸ Staff there also said that in remote areas the problem of staff retention is also caused by a lack of decent accommodation beyond that offered by staff quarters, and lack of access to a car.²¹⁹
- 6.136 A clinical psychologist at the Greater Southern Area Health Service confirmed that barriers to recruitment include accommodation issues.²²⁰ He told me that when he first went to Narrandera there was no accommodation: he could not find a place to rent, so he was put up in the staff quarters at the hospital and had to pay twice as much as other professions such as nursing and medicine; thus, he ultimately bought a house.²²¹
- 6.137 A representative of NSW Health conceded that a major problem associated with recruiting nurses to rural areas was the lack of accommodation:
- "Accommodation is a major issue. People don't go for clinical placements, because there's nowhere to stay, and then when you want to recruit people ... you have nowhere - they can't rent a flat or a house, because it just doesn't exist."²²²
- 6.138 NSW Health has made some arrangements with respect to the accommodation of medical officers on rotation to certain country hospitals as part of a networked training program. For instance, where a medical officer continues maintaining his or her original accommodation when on rotation to another area health service, and is accommodated in quarters at the rotation facility, no charge is made for the board or accommodation supplied at the rotation facility (subject to the doctor providing evidence, such as rental receipts, to the rotation facility).²²³ It seems to me that this only goes a short way to addressing what is quite obviously a very pressing problem.
- 6.139 In the next section, I will consider the research concerning the factors that have been found to entice people to work in rural and remote regions.

How can we attract health workers to rural and remote NSW?

- 6.140 During the Inquiry, my attention was drawn to research on how people can be enticed to work in rural and remote locations.
- 6.141 In its 2002 *NSW Rural Health Plan*, the NSW Government noted that the Rural Health Implementation Coordination Group identified a number of key elements affecting the success of rural recruitment, including (amongst other matters) limited career paths, professional and social isolation, accessibility of educational opportunities, and the availability of suitable accommodation.²²⁴
- 6.142 A review of research on job satisfaction in nurses in rural Australia undertaken by Desley Hegney and Alexandra McCarthy found that nurses are attracted to working in rural areas primarily for family or social reasons.²²⁵ In this regard, they noted that many nurses have no choice in the matter: for example, spouses may farm in the area or have other employment commitments.²²⁶ The researchers reported, however, that many nurses choose to work in rural areas:

"(Some) nurses deliberately choose a rural lifestyle, perhaps having been born and raised in rural areas and valuing the family and social networks not accessible to

them in metropolitan areas. Some rural nurses cite the attraction of the rural environment and the more relaxed, healthy lifestyle that it offers. In contrast, not many professional benefits appear to be attracting nurses to rural areas (eg, promotion or financial incentives). The data indicates that nurses from metropolitan areas choose to relocate to rural health services for the variety of nursing experience it offers rather than for career or financial advancement."²²⁷

- 6.143 The researchers reported that factors positively correlated with job satisfaction include hospital size (with nurses working in health services facilities of 50 or fewer beds reporting the highest level of job satisfaction in rural Australia), role diversity, ease of access to professional education and training, positive employer support, and constructive relationships with the community and other health professionals.²²⁸ They thus suggested that marketing strategies be aimed at promoting both the high level of job satisfaction acquired from role diversity, which is inherent in rural nursing practice, and the high level of job satisfaction that nurses derive from constructive community relationships, which (arguably) are more easily fostered in smaller rural health services.²²⁹
- 6.144 2007 West Australian research on attracting and retaining skilled and professional staff in remote locations in that state found that housing was a key determinant for attraction and retention of staff and their families.²³⁰ The author observed:
- "Housing in remote locations is often old or 'transient', expensive to maintain, lacking in aesthetic character, inappropriate for the climatic conditions and often in short supply."²³¹
- 6.145 She made the following further observations:
- "Successful strategies for the attraction and retention of professional and skilled staff involved around giving potential residents a 'suck it and see' experience. ... [M]any of the myths and less than congenial image of remote towns and remote services are 'busted' by the diverse medical experience, the warm welcome given the visitors and the varied social experiences offered by a remote community."²³²
- 6.146 Significantly, Mercer Human Resources Consulting was recently commissioned by NSW Health to conduct a review of its attraction and retention practices.²³³ The researchers said the following about the viability of financial incentives as a recruitment tool:
- "One thing that Mercer has consistently found is that remuneration and financial benefits rarely are listed as a motivator, although 78% of Australian employees who believe they are being fairly paid do not consider leaving their employer. These findings confirm research that suggests that remuneration tends to be more of a 'hygiene' factor than a motivator. That is, remuneration has the power to de-motivate employees if it is perceived as unfair, but you have limited value to attract and/or motivate employees beyond this."²³⁴
- 6.147 The researchers reported that the largest barriers to attracting and retaining health workers in remote areas is the nature of the work and its usefulness in ongoing skills development.²³⁵ The researchers found that meaningful and challenging work was regarded as the most effective career-based method of attracting specialist staff to rural

locations.²³⁶ They noted that access to professional and career development opportunities was also seen as “somewhat effective”.²³⁷

6.148 In terms of non-financial benefits, the researchers made the following observations:

“More flexible HR policies that provide family-friendly working hours, flexible working arrangements and generous leave entitlements are particularly important as a complement to the marketing of rural locations – people require time to enjoy the oft-cited lifestyle benefits.”²³⁸

6.149 They also noted that a lack of suitable infrastructure was reported as a barrier to recruitment of doctors, and that an effective practice was providing accommodation to staff, to improve both the availability and quality of housing options.²³⁹

6.150 They also noted that current incentives merely reward people who are already committed to a rural position, and did little to attract others:

“It would appear that these types of arrangements overcome financial disincentives to relocate to rural and remote areas, but of themselves do not offer a strong attraction mechanism which would lead individuals not currently considering relocating to rural and remote areas to seriously consider doing so.”²⁴⁰

6.151 Amongst other matters, the researchers recommended that NSW Health:

- review the approach to advertising of NSW Health roles in rural and remote locations in the context of both content and style;
- explore the creation of rural/remote practice as a specialist stream that is supported by professional qualifications and recognition, as well as appropriate support and management mechanisms;
- consider the introduction of location allowances that differentiate on the basis of degree of remoteness; and
- continue to focus on supporting the integration of professional health care workers and their families into their new communities, both initially and on an ongoing basis”.²⁴¹

Partnerships

6.152 Several hospitals in remote or rural areas have struck up partnerships with metropolitan hospitals in order to access medical and nursing staff when needed, and to give people working in the city an opportunity to ‘test the waters’ of working in a rural or remote area.

6.153 During my visit to Wyong Hospital I gained the impression that Wyong clearly suffers from the difficulty of attracting specialists to work there.²⁴² I was told that the method being used to overcome this is for the hospital to work in close connection with Gosford Hospital.²⁴³ Hopefully, over time, this will prove to be of benefit.

6.154 A locum doctor at Broken Hill Hospital told me that the hospital encounters great difficulty in securing people for permanent jobs in Broken Hill, because of its remoteness.²⁴⁴ He said that those who do work at Broken Hill make a commitment to the health service and work extremely hard to fill the gaps, including taking responsibility for teaching and service planning.²⁴⁵ He offered the following solution to the recruitment problem:

"Throwing more money of itself is not necessarily the answer. The answer has to be with sufficient money to allow a flexible sort of service provision, such as service agreements with doctor groups in Adelaide so that you can have the ongoing steady commitment to the health service. It is about recognition though that the extra money that it actually does cost to provide the service is a legitimate cost and is not held against the health service because we are costing more per unit of output and outcome because of those extra overheads that the health service has to bear."²⁴⁶

6.155 The Health Service Manager at Bourke Hospital told me that she would like to develop a formal partnership between Bourke Hospital and Prince of Wales Hospital, under which nursing staff at Prince of Wales could be offered the opportunity to work at Bourke.²⁴⁷ The witness told me that in the past, she had had to speak to Prince of Wales' workforce development officer to secure nurses for relatively short periods to get Bourke Hospital out of a "tight squeeze".²⁴⁸ I note that this would give city nurses and other clinicians the chance to see if they like rural practice.

6.156 Indeed, this witness also told me that people may be cautious about working in remote, indigenous areas, and draw some comfort from the fact that they are supported by a formal program.²⁴⁹ She observed that if new staff find that they like working in the area, they then have the option of taking up an incentive package.²⁵⁰

6.157 One solution proffered by an enrolled nurse at Tamworth Base Hospital was for nurses to be afforded the opportunity to take up short-term contracts in rural areas, while maintaining job security at their main place of employment.²⁵¹ She said that this would allow staff to "trial" the rural lifestyle without requiring them to make a commitment to staying in an area.²⁵²

6.158 The Assistant Service & Operations Manager of Outback Eye Service at Bourke told me that there was no shortage of specialists who are prepared to come to the Eye Service to do surgery.²⁵³ In this context, she stated:

"Certainly with the registrar training program, we have been able to re-train the staff who come here, who love the experience, who are welcomed into the community, and they have gone on to work for us in the future."²⁵⁴

6.159 She told me that although people are prepared to work at Bourke, the stumbling block is often that there is no one to coordinate the person's move to the area.²⁵⁵

6.160 Partnerships between hospitals seem to me to be a very sensible solution to the shortage of clinicians in rural hospitals. Indeed, the West Australian researchers who studied the attraction and retention of skilled and professional staff in remote locations in that state, made the following observations on the value of partnerships:

"While the word 'partnership' is over-used, it was very evident that government recognition of its responsibility to the needs of remote communities which is equally matched by corporate sector investment and community commitment is likely to reap long-term benefits and a sustainable future. However, without that mutual and equal commitment, the attraction and retention of a professional and skilled workforce in remote locations will remain a significant challenge."²⁵⁶

Compulsory placements

- 6.161 Each of the above efforts to bring the distribution of the workforce into line with the needs of patients is to be commended and supported in the ways that I have recommended. However, I do not think that these measures will go far enough to achieve equal access for all people in NSW to medical services.
- 6.162 Whilst the concept of compulsory placements of health professionals was not greeted with enthusiasm by doctors, I think it may have a place in the short-term, until the impact of the increasing number of medical graduates begins to be felt. Indeed, the Head of the Division of Surgery at Shoalhaven Hospital told me that in his view, as part of the training of Emergency physicians, they should be required to spend time in peripheral hospitals.²⁵⁷ He suggested that this be centrally handed, perhaps in conjunction with the College of Emergency Medicine and NSW Health.²⁵⁸
- 6.163 However, I note that the Director of Anaesthesia at Tamworth Base Hospital did not think that provisional fellows could be made to engage in a compulsory rural rotation because, in her view:
- "[d]octors don't like compulsory rotation of anything."²⁵⁹
- 6.164 Compulsory placements are already a feature of most College training programs. In my view, they should be compulsory for prevocational doctors as well.

Tele-medicine

- 6.165 In several facilities across NSW, I was impressed with the potential for tele-medicine facilities to provide rural patients and clinicians with 24-hour a day, 7-days a week specialist support equivalent to that enjoyed in metropolitan Sydney.
- 6.166 Tele-medicine (also referred to as tele-health) provides a vital role in the rural setting, enabling rural and remote hospitals to link up with regional or metropolitan hospitals for advice. Tele-medicine involves the transmission of images, voice and information between two or more health units through digital telecommunications, to provide clinical advice, consultation, and education and training services.²⁶⁰
- "Telehealth allows patients to receive improved access and choice to specialised health care, and limits their travel costs by providing more health services in their local community. Telehealth also plays an integral role in the recruitment and retention of the health workforce, through the provision of support and mentoring, and the provision of education and training."²⁶¹
- 6.167 I received evidence regarding a number of small or pilot projects using tele-medicine in NSW. This evidence pointed to the advantages tele-medicine provided in remote and rural communities, but also that, to date, NSW has failed to take adequate advantage of tele-medicine's possibilities.

Emergency Department

- 6.168 Dr Hungerford, the Director of Clinical Care at Tamworth Hospital, expressed the view that tele-medicine enhances the ability of clinicians at Tamworth Hospital to support doctors in more remote areas.²⁶² Tele-medicine gives him many visual or auditory cues, as it is possible to zoom in the monitors on the patients and get information that the rural GP may be unable to convey by telephone.²⁶³ It enables him to tell whether

the patients are too good to retrieve, too bad to retrieve and, if they are retrieved, whether they need to go straight to surgery rather than to the Emergency Department.²⁶⁴ The use of tele-medicine can significantly reduce the number of patient transfers.²⁶⁵ Dr Hungerford's view was that, at present, tele-medicine is under-utilised.²⁶⁶ I agree.

- 6.169 The Virtual Critical Care Unit (ViCCU) at Nepean Hospital uses broadband internet to deliver a tele-medicine service. Clinicians reported that the use of ViCCU allowed them to increase the decision support provided to clinicians at Blue Mountains Hospital.²⁶⁷ Professor Cregan told me that:

"Immediate benefits were noted upon implementation of the ViCCU in the ED at [Blue Mountains Hospital], with staff having access to specialist emergency medical consultation 16 hrs per day, 7 days a week. The project was evaluated [and found that it resulted in] ... less local admissions and more transfers of critically ill patients and a significant increase in the rate of discharges for minor trauma patients. ..."²⁶⁸

- 6.170 I was informed that a lack of adequate funding has reportedly prevented the continuation and extension of the ViCCU.²⁶⁹

Obstetrics & gynaecology

- 6.171 Dr Pardey, the Clinical Director of Obstetrics and Gynaecology at Nepean Hospital, told me:

"[W]hat I do ... requires being in a clinically effective position with the ability to make difficult decisions quickly and sometimes problematic decisions with unfortunate outcomes. The difficulty for rural Australia is the ability to make those difficult decisions, and that can be digitally supported, and there are ways of doing that, but it isn't free. If you have good-quality larger central hospitals with someone senior on site, then those onsite people are available for electronic consultation through the rural areas."²⁷⁰

Pharmacy

- 6.172 I heard evidence of a tele-medicine project in Queensland providing pharmacy support:

"The [Safe Medication Practice Unit] at Queensland Health have developed a model of using telehealth to link a pharmacist in metropolitan hospital with rural hospitals without on site pharmacy services. The pharmacist communicates with the medication team - nurses and doctors - by teleconferencing facilities and assists with medication reconciliation, medication chart review, medicines information inquiries and planning for discharge."²⁷¹

Mental health

- 6.173 Tele-medicine facilities are also proving vital in providing mental health services to rural and remote areas.
- 6.174 During my visit to Bloomfield Hospital, a specialist mental health institution at Orange, I observed the tele-medicine pilot program, which enables clinicians at Bloomfield Hospital to interview patients in a number of public hospitals in remote locations within the Greater Western Area Health Service. The scheme allows psychiatric staff at

Bloomfield to assess a patient with the assistance of a high definition link to the remote hospital. Two trained psychiatric nurses are available 24 hours a day, 7 days a week, with a bank of televisions on the wall connected to outlying far western hospitals and community health places. Through this system, a nurse at Walgett Hospital, for example, can contact the psychiatric nurses at Bloomfield Hospital via video-link, giving the nurse at Walgett immediate specialist support. The psychiatric nurses in the Bloomfield Hospital control room might then, if necessary, dial up a psychiatrist at home in Sydney or Orange, or one on-site, and there is immediate further specialist support being provided for that patient and clinical staff.²⁷²

6.175 The staff anticipate a reduction of 50% in patients presenting at Bloomfield as acute cases where patients can be assessed by tele-psychiatry and could be better treated in their home areas – thus providing large savings in costs to the police, ambulance and psychiatric nursing services.²⁷³

6.176 Such tele-medicine facilities are being piloted at Mudgee, Broken Hill, Bourke, Walgett and Wilcannia.²⁷⁴ If successful, the pilot programme may be extended to 9 other public hospitals in the Greater Western Area Health Service.²⁷⁵ Certainly, the comments I heard from clinicians were favourable.

- During my visits to Bourke and Walgett District Hospitals I was told that tele-medicine provides an excellent service and has reduced the need for transfers, which are often very difficult as I have already outlined.²⁷⁶
- I was told by nurses at Walgett District Hospital that it provides an alternative to calling in local doctors for every consultation, lightening their on-call load significantly.²⁷⁷

6.177 In the Greater Southern Area Health Service, the Chisholm Ross Centre, which is an acute psychiatric admissions unit on the grounds of the Goulburn Base Hospital, has a Mental Health Emergency Consulting Service, which will have video links to the Emergency Departments of the 16 hospitals which refer to it, and provides a tele-psychiatry service.²⁷⁸

6.178 Wagga Wagga Base Hospital has mobile video-conferencing and tele-psychiatry facilities in Emergency Department and generally within the hospital connected to all outlying hospitals within its catchment area. I am told that as a result of the outreach program, there has been a large reduction in admissions to the Wagga Wagga Emergency Department from outlying hospitals.²⁷⁹

"Essentially what happens is that the trained staff will see a patient ... online or in the emergency department here, they will discuss the case with the psychiatrist on call and then produce a plan, but some of the improvements that are made (are) not just the outreach of being able to see patients in other regions and being able to give them reasonable care where they are without having to drive three or four hours, but ... also training the staff at the other sites, be it in the emergency department here or at the regional hospitals."²⁸⁰

6.179 I was very impressed with the how tele-medicine ameliorated many of the problems with emergency mental health in rural and remote NSW, and I am of the view that these facilities should be provided as quickly as possible to all rural and remote Emergency Departments which do not have on-site after-hours mental illness professionals.

Wider application of tele-medicine

- 6.180 I consider that tele-medicine services can be used to support a much better, cost-effective system for remote and regional and also outer-metropolitan NSW not only in mental health, but in many diverse areas. There would be strong community support in rural and remote areas for tele-medicine facilities were local people able to see the value of these links in bringing real-time specialist advice to their areas.
- 6.181 In order to facilitate a wider application of tele-medicine services, the NSW Health system needs a secure and reliable broadband network which services the entire state. I have discussed this further in Chapter 14.

Loss of medical services

- 6.182 I heard a considerable amount of evidence, and received many submissions, about the loss of medical services in rural and remote areas. Elsewhere in my report, I have discussed:
- (a) a loss of maternity services in Chapter 4;
 - (b) the lack of pathology and medical imaging in Chapter 24, together with proposed solutions; and
 - (c) the appropriate location of expensive equipment for, say, radiotherapy and oncology services, throughout the state in Chapter 30.

Rationalising rural hospitals

- 6.183 In Chapter 26, I have discussed the considerations which lead, in modern times, to the rationalisation of the network of hospitals across NSW, being patient safety, critical mass and efficiency.
- 6.184 I received submissions from clinicians working in major regional hospitals who are well aware of the need for critical mass.
- Some clinicians, such as Dr Gerard Carroll of Wagga Wagga, submitted that critical mass has been achieved in their regional centre. Dr Carroll told me Wagga Wagga Base Hospital has a critical mass of specialists from multiple disciplines, supported by a “nursing factory” at Charles Sturt University, a strong division of GPs, and a critical mass of medical infrastructure, including from the private sector.²⁸¹
 - Other clinicians, and local politicians, pointed to obstacles to achieving critical mass posed by problems with workforce distribution, a lack of infrastructure, resources and planning.²⁸²

Revitalising rural hospitals

- 6.185 I have elsewhere observed that,
- (a) major non-metropolitan hospitals appear to me to be quite overwhelmed with their workload; and
 - (b) ‘second tier’ hospitals in regional and rural areas appear to me, generally, to have facilities with low bed occupancy and surgical facilities either under-utilized or not used at all.

- 6.186 As elsewhere explained, I consider that there is a place for re-invigorating smaller rural hospitals to take the overload from major non-metropolitan hospitals in clearly defined areas such as low risk surgery. This can be achieved by:
- (a) clear role delineation; and
 - (b) clinician reorganisation.
- 6.187 I illustrate, below, what I propose in respect of surgery.

Use of rural hospitals for non-tertiary surgery

- 6.188 It is clear to me that most major regional and metropolitan hospitals have more surgery than they can comfortably manage. I received a considerable amount of material in this context in relation to Dubbo.

- A doctor from Dubbo expressed concerned that the theatre case load at Dubbo Base Hospital is increasing by 10 to 16% per annum and yet there is no plan to increase facilities or limit procedures. The current surgical workload is being managed by working late into the evening: surgery is not finished until after midnight more than half of the time. Emergencies account for 39% of surgeries, yet there is no daytime emergency theatre.²⁸³ The doctor described the situation at Dubbo Base Hospital as:²⁸⁴

"a disaster waiting to happen and the stresses being placed on clinicians are intolerable. The response of administrators is akin to rearranging the deckchairs on the Titanic."

- A Dubbo surgeon told me that the waiting time for surgery is excessive. Currently over 900 patients are waiting to be seen in his clinic.²⁸⁵
 - A Dubbo locum surgeon explained that the surgical workload has increased significantly over the time that he has been visiting Dubbo and is now nearly equal to Orange and Bathurst combined. Most emergency surgery is not done until after 8pm (statistically a dangerous time for surgery). In his opinion, Dubbo needs at least one, if not 2, more operating theatres and the appropriate extra staff to cope with this increased workload.²⁸⁶
 - I was told by a senior Dubbo doctor that Dubbo has comparatively fewer anaesthetists and surgeons than other major non-metropolitan hospitals, with the result that there has been a significant downgrading of procedures. Currently, women who need a stereotactic biopsy of their breast need to travel to another regional centre. No mammotome and no interventional angiography can be performed in Dubbo. The current theatre capacity is running with 32 full-time nurses, while 41.87 nurses are required according to a KPMG audit.²⁸⁷
- 6.189 It is also clear to me that a number of smaller rural hospitals have under-utilised operating theatres and relatively low rates of occupancy in their wards. The staff working at these hospitals have valid concerns about the loss of skills given the lack of surgery, and the potential for loss of facilities going forward.
- I was told that at Bellinger River Hospital that the number of surgeries performed each year at the hospital has reduced from 700 in the 1990s to about 310. The operating theatre only operates 6 days a month, with surgery performed by 2 general surgeons and a gynaecologist from nearby Coffs Harbour. The surgeons perform relatively minor low-risk surgeries and some obstetrics. They no longer have after-hours operating theatres. The GPs who work at the hospital expressed concern that they will lose facilities at the local hospital.²⁸⁸

- The Tweed Hospital is under pressure with occupancy rates, while Murwillumbah has vacancies. The operating theatres at Murwillumbah are only used 35% of the time, and the occupancy rate of its surgical ward is around 60%. It was suggested to me that the resources at Murwillumbah could be used to take the pressure off The Tweed Hospital. One submission was that all planned orthopaedic surgery could be transferred to the operating theatres at Murwillumbah.²⁸⁹
 - Similarly, I was told that planned surgery at Port Macquarie Base Hospital is disrupted daily due to bed block, lack of intensive care beds, and an increasing volume of emergency cases. A doctor from the hospital told me that there is an urgent need for extra operating theatre space, time and beds.²⁹⁰ On the other hand, nearby hospitals at, say, Kempsey, have under-utilised operating theatres and surgical wards, as I have outlined in Chapter 23.
 - One witness from Kempsey²⁹¹ told me that when she started working at the Kempsey Hospital as a nurse almost 20 years ago, they were involved in a large range of complicated operations such as hip replacements, other orthopaedic procedures and bowel surgery. Now the hospital only does simple day surgery such as eye surgery and colonoscopies. Kempsey Hospital performs approximately 1,200 operations per year, 99% of which are day surgery.²⁹² However, the witness also told me that the surgeon who used to undertake the more complicated operations in the 1990s no longer lives in Kempsey and there is no surgeon there today.²⁹³
 - Along the highway about 60km from Kempsey is Port Macquarie. At Port Macquarie Hospital I heard that they have a lack of beds. Planned surgery is disrupted every day due to cancellations caused by a lack of beds in the hospital or in intensive care. About 20% to 30% of planned procedures are cancelled for this reason. I was told that at this hospital they are still working on budgets and resources that were planned for in the early 1990s.²⁹⁴
- 6.190 The ramifications of sending all surgery, whether simple or complex, to major centres, is particularly stark in remote and rural centres. A particularly interesting example of this problem was Bourke. The effect on the whole community is worth examining in detail in the case study below.

Case study: Bourke

- 6.191 Bourke has a new hospital with a beautiful operating theatre which is largely un-used. The hospital and nursing staff were described to me as having considerable surgical experience and expertise.²⁹⁵
- 6.192 I was told that the operating theatre was used in the past for orthopaedic procedures, general surgery and gynaecological procedures, but this stopped when the specialists performing these surgeries retired. I was told that while the hospital staff knew of a young specialist who was keen to come to Bourke, the area health service did not support it and it did not happen.²⁹⁶
- 6.193 The reason given was that there were not enough people on the waiting list to continue the service in Bourke.²⁹⁷ This was described to me as something of a 'chicken and egg' problem: there is no waiting list because there are no surgeries being performed in the hospital, nor specialists travelling to the hospital to see prospective surgical cases:

"We need a waiting list. There is no waiting list because we have not had a gynaecologist for so long. So we have taken it on board to have clinics and get a waiting list up and then see if we can persuade the Area

Health Service to allow the operating theatres to be used for minor procedures".²⁹⁸

- 6.194 I was informed that people are sent out of town and consequently the waiting list in town does not reflect the demand for surgery enough to warrant bringing a surgeon to town.²⁹⁹
- 6.195 Eye surgery is still conducted at Bourke every 2 months by a team from Prince of Wales Hospital. I was told that visits from the Prince of Wales team are much anticipated, and their visits help keep the skills of local clinicians up to date.³⁰⁰ The hospital also performs emergency and planned caesareans with the help of GP anaesthetists.³⁰¹
- 6.196 Several problems are created by the lack of surgery in Bourke.
- (a) A registered nurse expressed concern that, as the hospital is only providing emergency and planned caesareans, the GP anaesthetists may not be able to maintain their skills by doing more complicated procedures and may leave. Local anaesthetic competence would be lost. If this occurs, the hospital would no longer be able to maintain their maternity services in Bourke.³⁰²
 - (b) A GP medical centre manager told me that the lack of an operating theatre service makes it difficult to attract GP proceduralists to Bourke. The Colleges have various requirements for continuing education and the lack of service provision makes it very hard for the GPs in the area to keep their skill levels up and conduct the required number of procedures.³⁰³

I note, in passing, a sensible suggestion made to me by the NSW Rural Doctors Network to remedy difficulties in GP anaesthetists maintaining their credentials where there are cut backs in procedural services. The NSW Rural Doctors Network suggested that NSW Health introduce state-wide credentialing for GP locums, thereby avoiding the need for locums working throughout the state to be credentialed by multiple area health services.³⁰⁴

- 6.197 There are also real problems with people having to travel to Dubbo (400 km away) or Sydney (800 km away) for surgery.
- (a) The indigenous population is particularly affected. About a third of Bourke's population are indigenous Australians, as are many living in the surrounding areas. I was told that if there is no local surgery, then Aboriginal patients do not know the surgeon in Dubbo or Sydney and feel uncomfortable. I was told that Aboriginal patients are sometimes fearful if they are sent to Dubbo or Sydney for surgery.³⁰⁵ I have discussed the limitations of the arrangements for assistance with transport presently provided for indigenous Australians below and more generally in Chapter 27.
 - (b) Elderly residents of Bourke are similarly affected. It is a 4 hour drive to Dubbo. This presents real problems for patients who are not able to drive themselves. Sometimes the surgery is only for minor procedures. As a local explained,³⁰⁶

"[w]e have a beautiful surgery here and ... I feel that losing these surgeries is really impacting on the town itself and people are just not having minor surgery that they should be having because they are putting it off and some of them are leaving it just too late".³⁰⁷

- 6.198 It was suggested that Bourke's facilities be used to take the pressure off Dubbo's overloaded operating theatres. One nurse said:

"If we could maintain our surgical services we may be able to reduce the backlog in the tertiary service at

Dubbo. One of the surgeons from Dubbo used to send his clients here because we didn't have a waiting list. They may be waiting months or years for the procedure in Dubbo, but they get in here straight away for simple procedures."³⁰⁸

6.199 One frustrated local explained:

"I'm not expecting the hospital to be able to provide more than just minor procedures. We are just asking for the minor procedures, no complicated procedures; I understand they have to go to the bigger hospitals. But it is such a shame, with such a talented group of men and women at the Bourke Hospital, all skilled to be able to support an operating theatre, and the doctors that we have here, their talents or their skills are waning because they are just not using those skills and they are not seen to be supported to use those skills. You've got a beautiful operating theatre and it's going to waste ... it's just such a shame."³⁰⁹

6.200 The additional cost involved in conducting non-tertiary surgery in Bourke seemed modest. I was provided with the following estimate, which includes the fees of the surgeon, the anaesthetist, theatre staff, consumables and ancillary costs such as accommodation and flights:

"If you're looking at running a surgical list of say 10 lists a year ... I would be estimating around \$80,000 to \$90,000 for that service to be provided locally."³¹⁰

6.201 The net cost to the public health system of providing the surgery in Bourke, when one takes into account the current cost of providing the surgery in Dubbo, would be about half of this amount. I was told that, in addition to these estimated expenses, some equipment may need to be purchased to meet the requirements of incoming surgeons. For example, I was told that an orthopaedic surgeon required equipment costing \$45,000 to \$50,000.³¹¹

6.202 It was suggested that surgeons be brought to Bourke from Sydney, via a formal partnership with a metropolitan tertiary hospital, as Dubbo does not have the capacity to provide the full range of surgeons to Bourke.³¹²

Solution

6.203 It seems to me that a possible solution to the dual problems of over-loaded major regional hospitals and under-utilised peripheral hospitals lies in moving non-tertiary surgical cases to selected smaller rural hospitals.

6.204 I saw this approach being taken in some rural hospitals, but it was the exception rather than the rule. It appeared to me to revitalise the peripheral hospital, and alleviate the over-load on major hospitals.

6.205 Macksville is one such example. Macksville has day surgery in which a variety of procedures requiring a scope, cataract and hernia operations are performed. The surgeons currently come from Coffs Harbour 3 days per week and it is anticipated that this may increase to 4 days per week. The smaller hospital is able to provide greater certainty as to the expected date of surgery in facilities that are spacious and without the feel of the larger hospital complex.³¹³

6.206 I have set out my recommendation in Chapter 23.

Mental health in rural and remote areas

- 6.207 The problems expressed to me in respect of the treatment of mental illness, as described in Chapter 22, were generally more keenly felt in rural areas.

Lack of mental health staff

- 6.208 I was also told of a lack of mental health staff in rural and regional areas.
- I was told that security guards were used in the place of nurses in Port Macquarie.³¹⁴
 - At Mudgee Hospital, where there are presently no trained mental health staff, mental health patients are reviewed by a doctor and transferred. Sometimes, mental health patients are placed in sub-acute beds, which is not particularly suitable.³¹⁵
 - At Wollongong Hospital, I was told that the mental health team is seriously understaffed. It has only 18 of the 25 full-time equivalent staff required by NSW Health's ratio of staff to patients. I was told of extensive delays in recruiting staff, with several positions vacant for over a year.³¹⁶
 - I was told that at Shoalhaven Hospital there are no acute psychiatric services available to public patients. I was also informed that it falls upon registrars to provide psychiatric care to scheduled patients who are transferred from rural hospitals.³¹⁷

Emergency mental health in rural areas

- 6.209 Emergency mental health care in areas is provided by hospital emergency units ranging from Level 1 facilities (small facilities with on-call nurses and access by phone to medical support) to Level 5 facilities (larger facilities located in regional centres with onsite inpatient psychiatric facilities). There are 131 hospital emergency units across rural NSW as follows.³¹⁸

Table 6.6 Rural Hospital Emergency Units in NSW

Service	Emergency Department Level				
	Level 5	Level 4	Level 3	Level 2	Level 1
No of units	5	13	30	71	12
Rural Psychiatric Emergency Care Centres RPECC	✓				
Mental Health Unit	✓	✓			
Mental Health Assessment Room	✓	✓			
Psychiatrist	On site	On call	Phone Consult.	Phone Consult.	Phone Consult.
Medical Officer	On site	On site	VMO – on call	VMO – on call	VMO – on call
Mental Health CNC/CNS	16 hours per day/ 7 days per week	16 hours per day/ 7 days per week	8 hours per day, and days per week visiting	Visiting	Visiting

Service	Emergency Department Level				
	Level 5	Level 4	Level 3	Level 2	Level 1
Tele-psychiatry facility	✓	✓	✓	✓	
Transport Team	✓	✓			
On call mental health staff to support transport e.g. HAS and TNS	✓	✓			
Mental Health Telephone Intake Line-Triage/Assessment		✓	✓	✓	✓

Source: NSW Health, Rural Mental Health Emergency and Critical Care Access Plan, 1 June 2006 (http://www.health.nsw.gov.au/pubs/2006/rural_mental_health.html)

- 6.210 Tele-medicine video-link is used to provide patients at remote Emergency Departments with mental health assessment, intervention and support in managing emergency mental health presentations.³¹⁹ I have already described the considerable benefits of tele-medicine in this field, and how it should be expanded.
- 6.211 I heard a considerable amount of evidence indicating that there is a lack of after-hours emergency mental health services in rural areas.

Safe assessment rooms

- 6.212 Mental health admissions most often happen after hours,³²⁰ and most rural hospitals have no on-site after hours psychiatric service or safe assessment rooms.³²¹ There is nowhere for the patient to be observed in a manner that is safe for the patient, other patients and the staff.
- 6.213 For example, at Muswellbrook Hospital I was told that on the weekend immediately prior to my visit a mental health patient in the Emergency Department was able to access the operating suite. Fortunately there was no operation then underway, but the potential for risk and damage was significant.³²²
- 6.214 The lack of such facilities means that mental health patients have to be transferred to another hospital which does have the necessary facilities. The limited staff available endeavour to transfer patients as quickly as they can, usually under difficult circumstances.³²³ Such transfers are very costly to all concerned: they use already limited ambulance, police and nursing resources, taking them away from rural and remote communities.³²⁴
- A nurse at Bourke told me that 3 or 4 mental health patients are transferred each week to Dubbo, about 4½ hours drive.³²⁵ Commonly, these transfers include a police escort and a mental health nurse.
 - A paramedic from a remote area told me how he spent 2 hours with a patient in the middle of the night in the middle of outback NSW while the police escorts sorted themselves out. The original escort, who came from the same remote town as the patient, was called back urgently, while the police officer from the receiving town refused to come unless the patient was further sedated.³²⁶

- 6.215 Clinicians called for safe assessment rooms so that they can treat patients whilst holding them, and avoid transferring patients.³²⁷
- 6.216 The problem is even worse in remote areas, which do not have permanent doctors but only doctors flown in by the Royal Flying Doctor Service or on weekly visits from larger centres. These facilities cannot have a safe assessment room because of the requirement that the patient be reviewed by a doctor every 3 hours.³²⁸
- 6.217 For example, in Wilcannia there is great need for a safe assessment room, but no permanent doctor to review patients every 3 hours.³²⁹ Consequently, the hospital does not qualify to be a “declared mental health facility” under the *Mental Health Act 2007*.³³⁰
- 6.218 It was suggested to me by a nurse at Wilcannia that this problem could be overcome if the law was amended to permit the patient to be reviewed by a senior nurse or a psychiatrist over a tele-medicine video link.³³¹ I agree.

Recommendation 13: *NSW Health should seek an amendment to the Mental Health Act 2007 to permit suitable remote facilities, specified in regulations to the Act, to operate safe assessment rooms for mental health patients on the basis that 3 hourly review of the patient may be undertaken by a senior nurse or psychiatrist over a video link.*

Transport of scheduled patients

- 6.219 Involuntary or ‘scheduled’ patients must be transported to an inpatient mental health unit which is authorised to accommodate them under the *Mental Health Act 2007*. As shown on the below map, a facility may be some distance away.³³²
- 6.220 In remote areas this means that as soon as possible after detaining the patient, and within 12 hours, local police need to transport a scheduled patient to the nearest hospital with an authorised medical officer on duty. From Wilcannia, for example, scheduled patients must be transferred 196 kilometres to Broken Hill, which is just over 2 hours drive.
- 6.221 Night transfers of acutely mentally ill patients in remote areas are not particularly safe, with wildlife on the road, poor quality roads and so on. It was submitted to me that NSW Health needs to gazette beds in these small facilities. I was told there were “multi-factorial cultural issues” that prevented this from happening.³³³ I do not understand what is being referred to.

NSW Health efforts

- 6.222 NSW Health has recently begun implementation of a Rural Mental Health Critical Care Plan, which I am told is intended to provide a more integrated network linking district hospitals to rural referral hospitals. Specialist mental health assessment and support is provided by clinical teams based in regional centres, or hubs.³³⁴ These clinical teams will also have the capacity to provide or coordinate safe and appropriate patient transport to regional mental health facilities, as well as outreach to smaller facilities (using tele-medicine). Under the Plan, a State Mental Health Telephone Access Line (SMHTAL) Improvement Project will be implemented. It will provide 24/7 access to mental health triage, advice and referral via a single state-wide mental health telephone service (as opposed to separate telephone services for each AHS, as currently). The service is to be staffed by mental health clinicians and linked to the National Health Call Centre.³³⁵ The project is expected to be completed in 2009.³³⁶

Inpatient mental health units

- 6.223 Outside metropolitan Sydney, inpatient mental health units are sparsely distributed across the State.

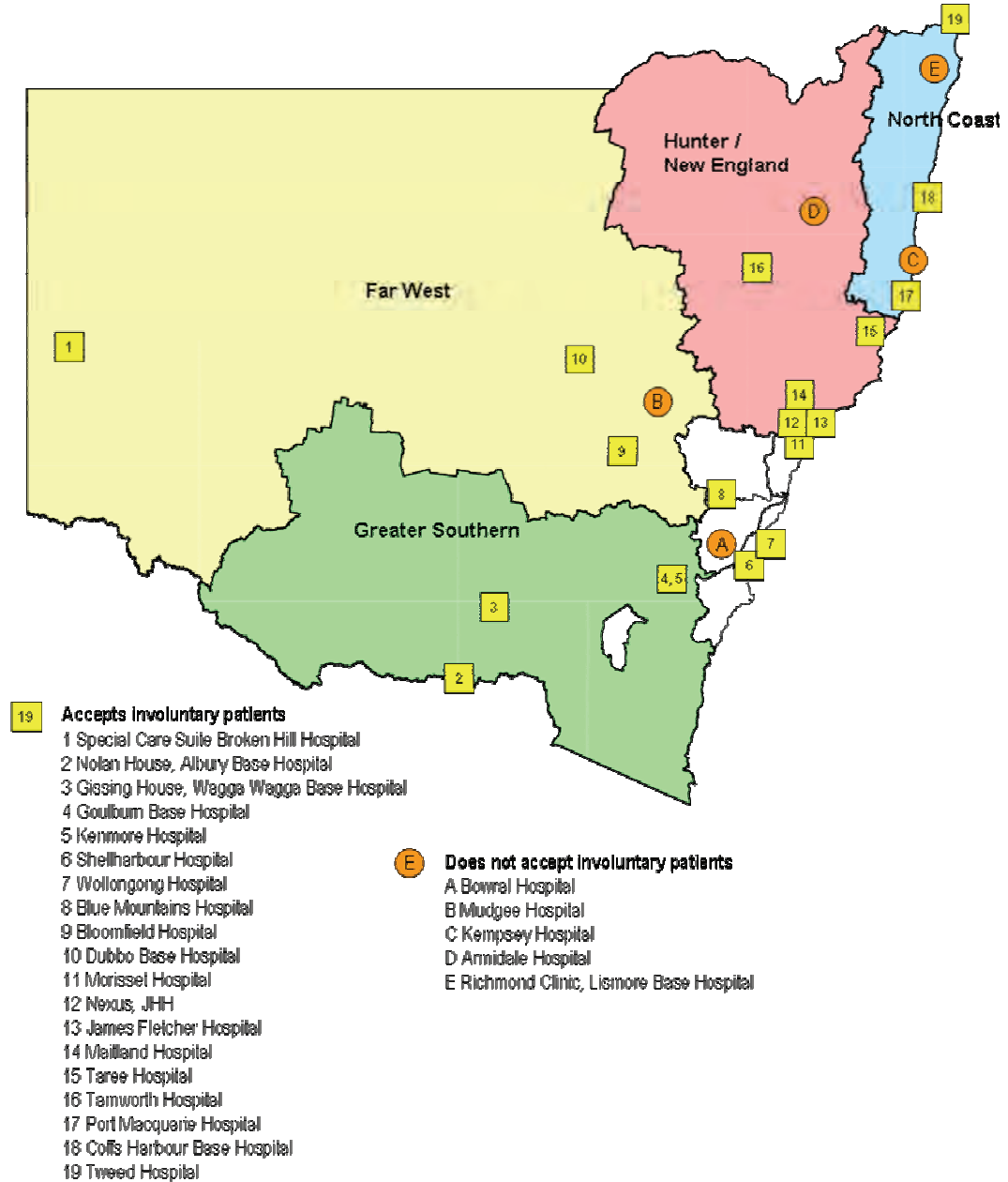

- 6.224 Where inpatient mental health units do exist, the evidence before the Inquiry was that the units are full to overflowing, with patients turning to Emergency Departments for emergency mental health treatment.

- I was told of extremely disturbed psychiatric patients being managed in the Emergency Department for up to 3 days at Coffs Harbour Hospital.³³⁷
- At The Tweed Hospital, I was told that there has been a significant growth in the number of mental health patients in recent years, unmatched by staffing and budgetary levels. As a consequence, the inpatient mental health unit is frequently full and patients overflow into the Emergency Department, which has only one partially secure room.³³⁸

- At Wagga Wagga I was told that in the preceding 6 months, 29 patients had to be transferred to other inpatient mental health units as there was no bed locally.³³⁹
- 6.225 Mental health services in rural NSW are generally understaffed, widely dispersed and therefore difficult to access, and have only a very limited capability to care for involuntary mental health patients. Yet according to NSW Health data, the clinical demands on rural hospital Emergency Departments are not greatly dissimilar to urban centres.³⁴⁰
- 6.226 If we do not change the requirements for safe assessment rooms and implement a fully-resourced tele-psychiatry service in all rural hospitals across the State, rural hospitals and communities in great need of these services will continue to struggle. Assessment and treatment of mental health patients in these communities will continue to be unsafe and unsatisfactory.

Transport back to regional and rural areas after treatment

- 6.227 It is a feature of the NSW health system that people in rural and remote areas often have to travel considerable distances to a regional or metropolitan hospital to receive specialist medical treatment.
- 6.228 Sometimes, the trip to the hospital is done in emergency circumstances, and NSW Health provides emergency travel to hospital very well, either by road or air ambulance. It does, however, mean that the trip was unplanned from the patient's point of view and they have left their car at home!
- 6.229 The trip home is another story. After treatment is completed, the patient is discharged and, generally speaking, left to find their own way home. This can cause real problems: patients may be stranded a long way from home and for many, it may not be safe to travel alone.³⁴¹ I was given many examples of situations where there was no public transport back to patients' home area and families were often required to drive a long distance to collect their relatives.³⁴² The same problem exists in regional areas.³⁴³ One social worker commented that there is very little consideration given to how to return people to where they live:
- "We are drowning under the issues of trying to get people back to their areas".³⁴⁴
- 6.230 There is no state-wide approach to this problem. I saw the following systems in place in various places across NSW:
- (a) volunteers driving a hospital car from Tenterfield to Armidale and Tamworth;³⁴⁵
 - (b) hospitals providing rail tickets or paying for a taxi;³⁴⁶
 - (c) hospitals booking emergency ambulances where the patients clinical condition did not need emergency transport;³⁴⁷
 - (d) local councils providing community transport;³⁴⁸
 - (e) hospital welfare departments and social workers providing support;³⁴⁹
 - (f) aboriginal health services providing a car and driver,³⁵⁰ or community bus service³⁵¹ from remote aboriginal communities to regional hospitals: I was told by the Walgett Aboriginal Medical Service that patients are sometimes brought home in the hospital linen trucks if their discharge time does not synchronise with the community bus.³⁵²

- 6.231 Sometimes these problems are dealt with by the regional or metropolitan hospital transferring the patient back to the hospital nearest their home for a few days, so that the patient can get closer to his or her home by inter-hospital transfer.³⁵³ Whilst well-intentioned, the cost of overcoming the deficiencies in the non-urgent patient transport system in this manner is grossly excessive.
- 6.232 I accept that there is a benefit in centralising health services, but with this comes a responsibility to enable equitable access to these services.³⁵⁴ The provision of transport services should extend to bringing patients to tertiary centres for follow-up consultations, and returning them home.³⁵⁵ This is because specialists at tertiary hospital may for clinical reasons be reluctant to hand care back to the referring hospital which will ordinarily be closer to the patient's home.³⁵⁶ The need to provide transport will depend upon whether the patient's frailty prevents them from taking more conventional modes of transport, or whether there simply are no convenient means of getting to the tertiary hospital. Tele-medicine services may be of assistance in this regard, and I have discussed these services above.

Indigenous Australians in remote areas

- 6.233 I was informed, and accept, that the travel of indigenous Australians from remote communities to the city for specialist treatment poses particular challenges. Many patients, particularly the elderly, miss appointments because they are afraid of going to the city and never coming back.³⁵⁷
- 6.234 The Aboriginal Medical Services do an admirable job in trying to arrange colleagues in the city to meet patients at the airport, and accompany them to the hospital and explain what is happening: for example, the requirement to fast. However, there is no system in place: it is a case of "just mates helping out".³⁵⁸ One solution put to the Inquiry was that patient escorts accompany these patients, or meet them on arrival in the city.³⁵⁹
- 6.235 It was suggested to me that funding for accommodation and meals is also needed, together with transport from the accommodation to the hospital and back.³⁶⁰ I have discussed this suggestion later in this chapter.
- 6.236 This is quite a difficult issue. I don't know how many patients would be affected by these problems. I don't know how much it would cost to bring in a new scheme for transporting and accommodating the families and carers of indigenous patients who need to go to the city for their hospital care.
- 6.237 I am not in a position to suggest a solution to this problem. I raise it here for others to examine and find the best way to help.

Recommendation 14: *NSW Health should address the transport problems associated with providing care for rural patients including:*

- (a) Abolishing the personal contribution and administration charge for all qualifying IPTAAS claims;*
- (b) that there is a need to create a non urgent transport service to be responsible for the return transport of patients from metropolitan or rural hospitals to either their hospital of origin or alternatively to their homes, depending upon their clinical condition.*

Financial assistance for travel expenses for rural and remote patients

- 6.238 There is no doubt that the need to travel some distance from one's home to receive medical treatment presents financial challenges for some patients.
- (a) Where the patient has access to a car, there is the cost of petrol.
 - (b) If the patient is treated as an outpatient, as many cancer and renal patients are, then they are likely to incur accommodation costs. Even if the patient is treated as an inpatient, their spouse or carer may have to find accommodation nearby.
 - (c) There are often other costs. Some rural people pointed to difficulties in making arrangements to run their farms in their absence, particularly where they did not have family living nearby and had no funds to pay for casual labour.³⁶¹

A question of policy

- 6.239 A threshold question is whether the NSW health system should provide financial and other assistance to patients who experience these difficulties, to facilitate their attendance at hospital for treatment. There are several points of view:
- (a) Such financial assistance is a type of income support, and this is traditionally a matter for the Commonwealth Government.
 - (b) If the cost of getting to a hospital to receive medical treatment is such that it prevents a financially disadvantaged patient from going to hospital at all, then financial assistance should be provided by the government agency best placed to identify such patients and assess their financial needs for assistance. In the absence of a scheme by the Commonwealth Government, NSW Health is probably that agency.
- 6.240 Whilst I sympathise with the view that the Commonwealth Government should be taking care of this, the reality is that the Commonwealth Government is not taking care of it, and the NSW Government has to step up to the mark.
- 6.241 The guiding principle is "equality of access". Once one accepts that we cannot take medical services to all of the population of NSW, then the only alternative is to take the people to the medical services and return them home. Whilst one can argue that this is a form of income support, that is ultimately not the correct principle. The overriding principle must be equality of access.

IPTAAS

- 6.242 To a limited extent, NSW Health has accepted the responsibility of ensuring equality of access. The Isolated Patients Travel and Accommodation Assistance Scheme ("IPTAAS") is a transport subsidy scheme for people who need to access specialist medical or oral surgical treatment that is not locally available to them.

Eligibility criteria

- 6.243 To be eligible for IPTAAS, a patient must:
- (a) be a permanent resident of NSW;
 - (b) usually live more than 100 km one-way from the nearest treating specialist;

- (c) be referred by a medical practitioner to the nearest treating specialist for specialist treatment;
- (d) receive treatment claimable under Medicare;
- (e) claim the maximum available benefits from their private health fund first; and
- (f) not be eligible for any assistance under any other government assistance scheme.³⁶²

6.244 These criteria and the claims process pose problems for patients. Many people (one of whom worked in hospital administration!)³⁶³ expressed to me the view that the process is complex and difficult to access.³⁶⁴ For example, there is an onus on the patient to remember to have their application signed by the treating specialist.³⁶⁵ Forgetting to do this at the time is not easily remedied. One applicant observed:

"Most people I know who have attempted to access this scheme has abandoned the effort, as we did".³⁶⁶

6.245 Similar evidence was identified by a Commonwealth Senate Standing Committee, which said that:

"the schemes that have been put in place to assist with access should not themselves form a barrier to that access".³⁶⁷

6.246 I was told that many people are not aware that they can access IPTAAS and chose not to visit a specialist as a result.³⁶⁸ Patients may not be informed about IPTAAS by referring doctors or provided with the forms.³⁶⁹

6.247 Many expressed the view that the amount of money recovered by a patient is often insufficient, especially where public transport is not easily accessible.³⁷⁰ Payment in advance is available in only limited circumstances and some complained of a delay in reimbursement.³⁷¹ Paying upfront can prove to be difficult for many.³⁷² Of this the Commonwealth Senate Standing Committee said:

"The evidence indicated that in some instances the financial burden is such that treatment decisions and health outcomes are compromised. In some cases, patients are choosing not to receive treatment".³⁷³

6.248 The Commonwealth Senate Standing Committee recommended that the Australian Health Ministers' Advisory Council "determine transport and accommodation subsidy rates that better reflect a reasonable proportion of actual travel costs and encourage people to access treatment early".³⁷⁴

Administration fee

6.249 An administration fee, or as NSW Health describes it, a "personal contribution", of \$40 is charged for each return trip claimed.³⁷⁵ The fee is reduced to \$20 for pension or health care card holders. The purpose of the fee is to increase the capacity for service provision and cover administration and management fees.³⁷⁶

6.250 I was told by many, including NSW Health, that this fee often negates any benefit derived from applying for IPTAAS.³⁷⁷

6.251 Although a person can apply for travel associated with a block of treatment in one claim, the administration fee is still charged for each return trip within the block of treatment.³⁷⁸ So, in one example I received, a patient from the Lismore area who made 21 trips for cancer treatment in Queensland, which was the most appropriate location for her

treatment, was entitled to a subsidy of \$30 for each return trip. However, this was wiped out by the \$40 administration fee charged for each trip.³⁷⁹

- 6.252 I note that NSW Health's Transport for Health policy specifically aims "to ensure that transport disadvantaged people are not prevented from seeking assistance due to the patient contribution".³⁸⁰ This seems at odds with the administration fee.

Conclusion

- 6.253 The frustrations with IPTAAS were best described by Dr Flecknoe-Brown at Broken Hill, who said that IPTAAS was set up,

"like a bread queue in Moscow. We haven't got enough money, so we make you wait. We make it as difficult as possible for you to do it."³⁸¹

- 6.254 That, indeed, seems to be the position. NSW Health does not regard itself as primarily responsible to provide this financial assistance. The funding available for it reflects this reluctance, as does the process to be endured to access it.
- 6.255 I agree that there should be a minimum distance requirement before a patient is eligible for financial assistance. The present 100 km threshold seems sensible to me, and I note that NSW Health will consider on a case-by-case basis claims for IPTAAS which fall below this threshold.³⁸²
- 6.256 However, the administration fee substantially negates the assistance being provided in many cases. It reduces IPTAAS to a form of "Clayton's" financial assistance and was the cause of strident criticism in evidence received by the Inquiry. I do not think that an administration fee should be charged to anybody.

Accommodation

- 6.257 IPTAAS only contributes to the cost of accommodation for a patient, or for their family to stay near a hospital while the patient receives medical treatment, in limited circumstances.
- 6.258 It is available for a patient where:
- (a) they have certification from their doctor that there is a genuine medical need for in-transit commercial accommodation;
 - (b) limited transport schedules require the patient to stay overnight before the specialist medical appointment or hospital admission and / or delay the return journey home; and
 - (c) where specialist medical treatment is carried out on an outpatient basis.³⁸³
- 6.259 It is available for families only if they are approved by a doctor as an 'escort' of a patient who satisfies certain clinical criteria, and:
- (a) for short stay procedures, where the cost of accommodation for the escort is less than the return trip to escort the patient home;
 - (b) where the escort is required to act as carer during long-term specialist outpatient medical treatment; or
 - (c) where the patient is hospitalised and the treating specialist certifies it is medically necessary for the escort to remain.³⁸⁴
- 6.260 Even where a subsidy is available, it is very minimal: \$33 per night for a single room.³⁸⁵

- 6.261 Hospitals sometimes arrange accommodation, but there is no specific scheme.³⁸⁶
- 6.262 The limited assistance available for accommodation can cause serious financial and logistical problems, particularly for rural and remote families who travel to a regional or metropolitan centre, often in emergency circumstances, for their relative's medical treatment.³⁸⁷ For complex patients, families may have to stay in a motel for some time, and this was reported by some rural nurses as being the source of great stress and frustration to families, which stresses were sometimes taken out on the nurses.³⁸⁸
- 6.263 It was impressed upon me that patients or their families find that accommodation costs a lot of money in these circumstances.³⁸⁹ A witness from Bourke conveyed the view that accommodation is just too expensive for people on the pension:
- "It's too daunting as well to take them out of their own environment where they've got family that they know, they've got support. I would find it daunting, let alone an elderly person."³⁹⁰
- 6.264 It seems to me that there is no real distinction between the cost of petrol or the cost of a motel. Either (or indeed, the combination of both) poses a financial hurdle that some people cannot overcome.
- 6.265 Following a recommendation by the Commonwealth Senate Standing Committee on Community Affairs, a national patient assisted travel scheme taskforce has been established to draft agreed principles for national minimum standards in relation to patient travel schemes.³⁹¹
- 6.266 In my view, NSW Health needs to examine options which would permit the IPTAAS scheme to be expanded to more adequately allow patients to claim for non-transport expenses incurred in the course of travelling a considerable distance for medical treatment. The criteria should be:
- the distance travelled; and
 - the patient's means.

¹ Professor Lynette Fragar, Armidale Hospital hearing, 26 March 2008, transcript 897.17-19.
² Information provided during visit to Goulburn Hospital on 28 February 2008.
³ Information provided during visit to Goulburn Hospital on 28 February 2008.
⁴ Information provided during visit to Bowral District Hospital on 16 April 2008.
⁵ Information provided during visit to Wellington District Hospital on 18 March 2008.
⁶ Information provided during visit to Wellington District Hospital on 18 March 2008.
⁷ Information provided during visit to Wellington District Hospital on 18 March 2008.
⁸ Alan Smith, Dubbo hearing, 19 March 2008, transcript 624.37-38.
⁹ Alan Smith, Dubbo hearing, 19 March 2008, transcript 624.38-45.
¹⁰ Alan Smith, Dubbo hearing, 19 March 2008, transcript 624.22-26.
¹¹ Alan Smith, Dubbo hearing, 19 March 2008, transcript 624.26-30.
¹² Alan Smith, Dubbo hearing, 19 March 2008, transcript 624.30-31.
¹³ Alan Smith, Dubbo hearing, 19 March 2008, transcript 625.42-43.
¹⁴ Alan Smith, Dubbo hearing, 19 March 2008, transcript 625.42-626.1.
¹⁵ Aryatilak Dissanayake, Mudgee hearing, 20 March 2008, transcript 730.44-731.5.

-
- ¹⁶ Martin Chase and Mary-Louise Fraser, *Report on Emergency Department Performance at Lismore Base Hospital*, 14 March 2008, SUBM.077.0031 at 6.
- ¹⁷ Submission of Dr Philip Truskett, General Surgeons Australia, 26 March 2008, SUBM.030.0086 at 3.
- ¹⁸ Submission of Dr Philip Truskett, General Surgeons Australia, 26 March 2008, SUBM.030.0086 at 7-8.
- ¹⁹ Confidential submission, SUBM.006.0232 at 3.
- ²⁰ Confidential submission, SUBM.006.0232 at 2.
- ²¹ Submission of the AMA (NSW) and ASMOF, 28 March 2008, SUBM.016.0015 at 22.
- ²² Dr Louis Christie, Orange hearing, 18 March 2008, transcript 532.1-5.
- ²³ Dr Louis Christie, Orange hearing, 18 March 2008, transcript 532.3.
- ²⁴ Professor Graeme Richardson, Wagga Wagga hearing, 22 April 2008, transcript 1963.2-3.
- ²⁵ Professor Graeme Richardson, Wagga Wagga hearing, 22 April 2008, transcript 1963.3-6.
- ²⁶ Information provided during visit to Dorrigo Multipurpose Service on 26 March 2008.
- ²⁷ Information provided during visit to Dorrigo Multipurpose Service on 26 March 2008.
- ²⁸ Submission of Dr Diane Campbell, 29 March 2008, SUBM.022.0013 at 7.
- ²⁹ Australian Government Department of Health and Ageing, *Report on the Audit of Health Workforce in Rural and Regional Australia, April 2008*, Commonwealth of Australia, Canberra at 8, citing Medicare data. The Remoteness Area Structure, adopted in the aforesaid Report from the Australian Bureau of Statistics' Standard Geographical Classification, breaks down geographical regions into 5 categories: major cities, inner regional, outer regional, remote and very remote. It is updated to take into account factors such as new road networks, new area boundaries and actual services provided through centres. "Inner regional centres" include albury and Ballina, while "outer regional" centres include Hay and Nambucca. For a full list of designations, see Attachment D of the aforesaid Report.
- ³⁰ NSW Rural Doctors Network, *NSW Rural General Practice Workforce Strategy – What Can We Do?*, January 2007, NSW Rural Doctors Network, Newcastle at 3.
- ³¹ Information provided during visit to Gulgong Hospital on 20 March 2008.
- ³² Information provided during visit to Cobar District Hospital on 8 May 2008.
- ³³ Information provided during visit to Cobar District Hospital on 8 May 2008.
- ³⁴ Information provided during visit to Walgett Aboriginal Medical Service on 9 May 2008.
- ³⁵ Information provided during visit to Wilcannia Health Service on 8 May 2008.
- ³⁶ Information provided during visit to Wilcannia Health Service on 8 May 2008.
- ³⁷ Information provided during visit to Wilcannia Health Service on 8 May 2008.
- ³⁸ Dr Phillip Hungerford, Tamworth hearing, 25 March 2008, transcript 848.22-26.
- ³⁹ Dr Phillip Hungerford, Tamworth hearing, 25 March 2008, transcript 848.25-26.
- ⁴⁰ Dr Phillip Hungerford, Tamworth hearing, 25 March 2008, transcript 848.26-29.
- ⁴¹ Dr Mark Henschke, Armidale hearing, 26 March 2008, transcript 292.31-36.
- ⁴² Dr Mark Henschke, Armidale hearing, 26 March 2008, transcript 292.36-38.
- ⁴³ Submission of Dr Hamish Steiner, 26 May 2008, SUBM.053.0092 at 2.
- ⁴⁴ Submission of Dr Fredrick Vethanayagam, 27 March 2008, SUBM.015.0178 at 2.
- ⁴⁵ Submission of Dr Ian Cameron, Rural Doctors Network, SUBM.003.0012 at 5.
- ⁴⁶ Submission of Dr Ian Cameron, Rural Doctors Network, SUBM.003.0012 at 5-7.
- ⁴⁷ Submission of Dr Ian Cameron, Rural Doctors Network, SUBM.003.0012 at 6-7.
- ⁴⁸ Submission of Dr Ian Cameron, Rural Doctors Network, SUBM.003.0012 at 7.
- ⁴⁹ Dr Phillip Hungerford, Tamworth hearing, 25 March 2008, transcript 848.22-29.
- ⁵⁰ Dr Phillip Hungerford, Tamworth hearing, 25 March 2008, transcript 851.21-24.
- ⁵¹ Dr Phillip Hungerford, Tamworth hearing, 25 March 2008, transcript 851.24-27.

-
- 52 Submission of Rozlyn Norman, 26 March 2008, SUBM.074.0087 at 2.
- 53 Submission of Rozlyn Norman, 26 March 2008, SUBM.074.0087 at 1.
- 54 Submission of Rozlyn Norman, 26 March 2008, SUBM.074.0087 at 2-3.
- 55 Submission of Rozlyn Norman, 26 March 2008, SUBM.074.0087 at 3.
- 56 Angela Monger, Gosford hearing, 10 March 2008, transcript 137.5-14.
- 57 Angela Monger, Gosford hearing, 10 March 2008, transcript 137.16-24.
- 58 Information provided during visit to Bowral District Hospital on 16 April 2008.
- 59 Confidential submission, undated, SUBM.027.0437 at 1.
- 60 Confidential submission, undated, SUBM.027.0437 at 1.
- 61 Information provided during visit to Wilcannia Health Service on 8 May 2008.
- 62 Gerard Jeffrey, Tamworth hearing, 25 March 2008, transcript 815.22-28.
- 63 Information provided during visit to Oberon Multi-Purpose Service on 17 March 2008.
- 64 Information provided during visit to Dorrigo Multi-Purpose Service on 26 March 2008.
- 65 Information provided during visit to Quirngi Hospital on 25 March 2008.
- 66 Confidential hearing at the Inquiry's offices via video link from Wagga Wagga, 30 May 2008, transcript 20.45
- 67 Obtained from the Commonwealth Department of Education, Employment and Workplace Relations. Physiotherapists (NSW)
<http://workplace.gov.au/workplace/Publications/LabourMarketAnalysis/SkillShortages/OccupationalReports/HealthProfessions.htm> (19 August 2008)
- 68 Obtained from the Commonwealth Department of Education, Employment and Workplace Relations. Occupational therapists (NSW),
<http://workplace.gov.au/workplace/Publications/LabourMarketAnalysis/SkillShortages/OccupationalReports/HealthProfessions.htm> (19 August 2008)
- 69 Services for Australian Rural and Remote Allied Health Inc, *New South Wales Allied Health Workforce*, <http://www.sarrah.org.au/site/index.cfm> (19 August 2008)
- 70 Public Hospitals (Professional and associated staff) Conditions of employment (State) Award page 4.
- 71 Submission of Emeritus Professor Kerry Goulston and Ross Kerridge, 27 March 2008, SUBM.005.0431 at 436-437.
- 72 NSW Health, Right of Private Practice – Allied Health Professionals in NSW Health Facilities (21 May 2008), PD2008_026.
- 73 New South Wales Government, NSW Health, Government Careers,
http://www.health.nsw.gov.au/countrycareers/career_opportunities/scholarships.html (26 August 2008).
- 74 NSW Health Briefing, 4 April 2008, transcript 95.10-18.
- 75 NSW Health Briefing, 4 April 2008, transcript 95.18-21.
- 76 Letter from NSW Health to Catherine Follent, Special Commission of Inquiry, 21 October 2008.
- 77 Commonwealth Department of Health and Ageing, *Report on the Audit of Health Workforce in Rural and Regional Australia, April 2008*, Commonwealth of Australia, Canberra at 15. See note 29 for a discussion of these 5 geographical classifications.
- 78 Commonwealth Department of Health and Ageing, *Report on the Audit of Health Workforce in Rural and Regional Australia, April 2008*, Commonwealth of Australia, Canberra at 17. See note 29 for a discussion of these 5 geographical classifications.
- 79 Commonwealth Department of Health and Ageing, *Report on the Audit of Health Workforce in Rural and Regional Australia, April 2008*, Commonwealth of Australia, Canberra at 20. See note 29 for a discussion of these 5 geographical classifications.
- 80 Information provided during visit to Cumberland Psychiatric Hospital on 13 May 2008.
- 81 Janet Long, Nepean Hospital hearing, 8 April 2008, transcript 1348.33-1349.16.

-
- 82 Information provided during visit to Concord Repatriation General Hospital on 21 February 2008.
- 83 Information provided during visit to Concord Repatriation General Hospital on 21 February 2008.
- 84 Information provided during visit to Concord Repatriation General Hospital on 21 February 2008.
- 85 Professor Philip Clingan, Wollongong hearing, 14 April 2008, transcript 1676.17-23.
- 86 Information provided during visit to Goulburn Hospital on 28 February 2008.
- 87 Information provided during visit to Quirindi Hospital on 25 March 2008.
- 88 Professor John Fraser, Tamworth hearing, 25 March 2008, transcript 773.10-20.
- 89 Dr William Monroe, Gosford hearing, 10 March 2008, transcript 118.26; Submission of Dr Andrew Hooper, 30 March 2008, SUBM.008.0017 at 6.
- 90 Submission of Professor John Fraser, Head of School of Rural Medicine, University of New England, SUBM.005.0238 at 1.
- 91 Meeting with the Institute of Medical Education and Training, 3 April 2008, transcript 57.
- 92 Meeting with the Institute of Medical Education and Training, 3 April 2008.
- 93 IMET, *News and Views of Medical Training in NSW*, Issue Number 5, August 2008.
- 94 Professor Graeme Richardson, Wagga Wagga Hospital, 22 April 2008, transcript 1966.
- 95 Dr William Monroe, Gosford hearing, 10 March 2008, transcript 118.
- 96 Dr William Monroe, Gosford hearing, 10 March 2008, transcript 118.24.
- 97 Submission of Professor John Fraser, Head of School of Rural Medicine, University of New England, SUBM.005.0238 at 2 and 3.
- 98 IMET, Discussion Paper Emergency Terms - A mandatory requirement for general registration in NSW?, DOC07/10681, www.imet.health.nsw.gov.au/, (20 November 2008)..
- 99 Professor Graeme Richardson, Wagga Wagga Hospital, 22 April 2008, transcript 1966.
- 100 Professor Graeme Richardson, Wagga Wagga Hospital, 22 April 2008, transcript 1966.
- 101 Professor Graeme Richardson, Wagga Wagga Hospital, 22 April 2008, transcript 1966.
- 102 Professor Graeme Richardson, Wagga Wagga Hospital, 22 April 2008, transcript 1966.
- 103 Dr Scott Whyte, Gosford hearing, 10 March 2008, transcript 100.
- 104 Dr Scott Whyte, Gosford hearing, 10 March 2008, transcript 101.
- 105 Dr Richard Cracknell, Liverpool hearing, 17 April 2008, transcript 1850.
- 106 Submission of Clinical Professor Phillip Harris, 27 March 2008, SUBM.041.0279 at 281.
- 107 Submission of Clinical Professor Phillip Harris, 27 March 2008, SUBM.041.0279 at 281.
- 108 Letter from Associate Professor Simon Willcock, NSW Institute of Medical Education and Training to Special Commission of Inquiry, 10 November 2008.
- 109 Letter from Associate Professor Simon Willcock, NSW Institute of Medical Education and Training to Special Commission of Inquiry, 10 November 2008.
- 110 Letter from Associate Professor Simon Willcock, NSW Institute of Medical Education and Training to Special Commission of Inquiry, 10 November 2008.
- 111 Letter from Associate Professor Simon Willcock, NSW Institute of Medical Education and Training to Special Commission of Inquiry, 10 November 2008.
- 112 Letter from Associate Professor Simon Willcock, NSW Institute of Medical Education and Training to Special Commission of Inquiry, 10 November 2008.
- 113 Submission of Drs Johnston & Farquharson, Kempsey District Hospital Medical Staff Council, 18 March 2008, SUBM.009.0142 at 2.
- 114 www.ranzcog.edu.au/; Dr Nicholas Stephenson, Wagga Wagga Hospital, 22 April 2008, transcript 2017.
- 115 Dr Nicholas Stephenson, Wagga Wagga hearing, 22 April 2008, transcript 2017.
- 116 Dr Richard Cracknell, Liverpool Hospital hearing, 17 April 2008, transcript 1856.

-
- ¹¹⁷ Submission of the Royal College of Pathologists of Australasia, undated, SUBM.014.0121, at 4; Confidential submission, 25 March 2008, SUBM.006.0232 at 2; Submission of Medical Staff Council of Children's Hospital Westmead, 31 March 2008, SUBM.014.0253 at 2; Confidential submission, SUBM.070.0273, at 5 and 6; Submission of the Australian and New Zealand College of Anaesthetists, 28 March 2008, SUBM.015.0023, at 7.
- ¹¹⁸ Submission of Drs Johnston & Farquharson, Kempsey District Hospital Medical Staff Council, 18 March 2008, SUBM.009.0142 at 2; Confidential submission, SUBM.006.0232 at 233.
- ¹¹⁹ Submission of Dr Warren Bruce, 15 April 2008, SUBM.021.0168 at 169.
- ¹²⁰ Submission of Dr Warren Bruce, 15 April 2008, SUBM.021.0168 at 169.
- ¹²¹ Professor Graeme Richardson, Wagga Wagga hearing, 22 April 2008, transcript 1969.
- ¹²² Professor Graeme Richardson, Wagga Wagga hearing, 22 April 2008, transcript 1970.
- ¹²³ Professor Graeme Richardson, Wagga Wagga hearing, 22 April 2008, transcript 1970.
- ¹²⁴ Dr Nicholas Stephenson, Wagga Wagga Base Hospital, 22 April 2008, transcript 2017.14.
- ¹²⁵ Submission of the Royal Australian and New Zealand College of Anaesthetists, 28 March 2008, SUBM.053.0196.
- ¹²⁶ Submission of the Australian Medical Association (NSW) Limited and the Australian Salaried Medical Officers' Federation, 28 March 2008, SUBM.016.0015.
- ¹²⁷ Submission of Dr Stephen Barratt, 28 March 2008, SUBM.0035.0088.
- ¹²⁸ Submission of Dr Stephen Barratt, 28 March 2008, SUBM.0035.0088.
- ¹²⁹ Confidential submission, 25 March 2008, SUBM.006.0232 at 233; Dr Scott Whyte, Gosford hearing, 10 March 2008, transcript 101.
- ¹³⁰ Confidential submission, SUBM.006.0232 at 233.
- ¹³¹ Submission of Dr Stephen Barratt, 28 March 2008, SUBM.0035.0088.
- ¹³² Meeting with the Medical Deans of Australia and New Zealand, 13 August 2008.
- ¹³³ Meeting with the Medical Deans of Australia and New Zealand, 13 August 2008.
- ¹³⁴ http://www.health.nsw.gov.au/countrycareers/about_nsw_health.html (13 November 2008).
- ¹³⁵ Dr Robert French, Armidale hearing, 26 March 2008, transcript 906.
- ¹³⁶ Confidential submission, 19 March 2008, SUBM.024.0173 at 173-174.
- ¹³⁷ NSW Health Briefing, 4 April 2008, transcript 63.35-36.
- ¹³⁸ NSW Health, *Area of Need Program*, <http://www.health.nsw.gov.au/othp/#> (30 October 2008).
- ¹³⁹ NSW Health, *Area of Need Program*, <http://www.health.nsw.gov.au/othp/#> (30 October 2008).
- ¹⁴⁰ NSW Health, *Country Careers*, http://www.health.nsw.gov.au/countrycareers/why_go_rural/initiatives_incentives.html#_Doctors (30 October 2008).
- ¹⁴¹ NSW Health, *Special Commission of Inquiry Presentation: NSW Health Workforce*, 4 April 2008, DOH.057.0074 at 27.
- ¹⁴² NSW Health Briefing, 4 April 2008, transcript 76.6-10.
- ¹⁴³ NSW Health Briefing, 4 April 2008, transcript 76.10-12.
- ¹⁴⁴ NSW Health, *Policy Directive – VMO in Rural Doctors' Settlement Package Hospitals Indexation of Fees from 1 August 2007*, PD2008_002, 3 January 2008.
- ¹⁴⁵ NSW Health, *Policy Directive – VMO in Rural Doctors' Settlement Package Hospitals Indexation of Fees from 1 August 2007*, PD2008_002, 3 January 2008.
- ¹⁴⁶ NSW Health, *Policy Directive – VMOs in Rural Doctors' Settlement Package Hospitals Payment for Travel and Attendance at Meetings*, PD2005_408, 27 January 2005.
- ¹⁴⁷ Dr Danny Beran, Prince of Wales Hospital hearing, 1 May 2008, transcript 2605.18-22.
- ¹⁴⁸ Dr Danny Beran, Prince of Wales Hospital hearing, 1 May 2008, transcript 2605.27-31.
- ¹⁴⁹ Dr Danny Beran, Prince of Wales Hospital hearing, 1 May 2008, transcript 2605.31-35.
- ¹⁵⁰ Dr Peter Finlayson, Tamworth hearing, 25 March 2008, transcript 828.34-42.

-
- ¹⁵¹ Dr Peter Finlayson, Tamworth hearing, 25 March 2008, transcript 828.46.
- ¹⁵² Dr Peter Finlayson, Tamworth hearing, 25 March 2008, transcript 828.9-13.
- ¹⁵³ Dr Peter Finlayson, Tamworth hearing, 25 March 2008, transcript 829.12-13.
- ¹⁵⁴ Dr Heather Dalgety, Bourke hearing, 9 May 2008, transcript 2696.16-27.
- ¹⁵⁵ NSW Government (Department of Premier and Cabinet), *Remote Areas Attraction and Retention Pilot 2006/2009*, http://www.dpc.nsw.gov.au/public_employment/finding_a_job_in_the_public_sector/remote_areas_forward/attraction_and_retention_pilot_20062009 (31 October 2008).
- ¹⁵⁶ NSW Government (Department of Premier and Cabinet), *Remote Areas Attraction and Retention Pilot 2006/2009*, http://www.dpc.nsw.gov.au/public_employment/finding_a_job_in_the_public_sector/remote_areas_forward/attraction_and_retention_pilot_20062009 (31 October 2008).
- ¹⁵⁷ NSW Government (Department of Premier and Cabinet), *Remote Areas Attraction and Retention Pilot 2006/2009*, http://www.dpc.nsw.gov.au/public_employment/finding_a_job_in_the_public_sector/remote_areas_forward/attraction_and_retention_pilot_20062009 (31 October 2008).
- ¹⁵⁸ NSW Government (Department of Premier and Cabinet), *Remote Areas Attraction and Retention Pilot 2006/2009*, http://www.dpc.nsw.gov.au/public_employment/finding_a_job_in_the_public_sector/remote_areas_forward/attraction_and_retention_pilot_20062009 (31 October 2008).
- ¹⁵⁹ NSW Government (Department of Premier and Cabinet), *Remote Areas Attraction and Retention Pilot 2006/2009*, http://www.dpc.nsw.gov.au/public_employment/finding_a_job_in_the_public_sector/remote_areas_forward/attraction_and_retention_pilot_20062009 (31 October 2008).
- ¹⁶⁰ NSW Government (Department of Premier and Cabinet), *Remote Areas Attraction and Retention Pilot 2006/2009*, http://www.dpc.nsw.gov.au/public_employment/finding_a_job_in_the_public_sector/remote_areas_forward/attraction_and_retention_pilot_20062009 (31 October 2008).
- ¹⁶¹ NSW Government (Department of Premier and Cabinet), *Remote Areas Attraction and Retention Pilot 2006/2009*, http://www.dpc.nsw.gov.au/public_employment/finding_a_job_in_the_public_sector/remote_areas_forward/attraction_and_retention_pilot_20062009 (31 October 2008).
- ¹⁶² NSW Health, *Information Bulletin – Remote Areas Attraction and Retention Pilot Incentive Package*, IB2007_014, 18 April 2007.
- ¹⁶³ NSW Health Briefing, 4 April 2008, transcript 97.4-7.
- ¹⁶⁴ Dr Sally Torr, Bourke hearing, 9 May 2008, transcript 2720.13-15 and 34-36.
- ¹⁶⁵ Dr Sally Torr, Bourke hearing, 9 May 2008, transcript 2720.36-39.
- ¹⁶⁶ Dr Sally Torr, Bourke hearing, 9 May 2008, transcript 2720.40-42.
- ¹⁶⁷ Dr Sally Torr, Bourke hearing, 9 May 2008, transcript 2720.44.
- ¹⁶⁸ Dr Sally Torr, Bourke hearing, 9 May 2008, transcript 2721.8-10.
- ¹⁶⁹ Dr Sally Torr, Bourke hearing, 9 May 2008, transcript 2721.19-20.
- ¹⁷⁰ Dr Sally Torr, Bourke hearing, 9 May 2008, transcript 2722.10-12.
- ¹⁷¹ Dr Sally Torr, Bourke hearing, 9 May 2008, transcript 2722.31-36.
- ¹⁷² Mary-Louise Davis, Bourke hearing, 9 May 2008, transcript 2688.17-29.
- ¹⁷³ Information provided during visit to Walgett Health Service on 9 May 2008.
- ¹⁷⁴ Information provided during visit to Walgett Health Service on 9 May 2008.
- ¹⁷⁵ Information provided during visit to Walgett Health Service on 9 May 2008.
- ¹⁷⁶ Information provided during visit to Walgett Health Service on 9 May 2008.
- ¹⁷⁷ Information provided during visit to Walgett Health Service on 9 May 2008.
- ¹⁷⁸ Information provided during visit to Walgett Health Service on 9 May 2008.
- ¹⁷⁹ Information provided during visit to Walgett Health Service on 9 May 2008.

-
- ¹⁸⁰ Dr Sally Torr, Bourke hearing, 9 May 2008, transcript 2721.11-15.
- ¹⁸¹ Mary-Louise Davis, Bourke hearing, 9 May 2008, transcript 2688.19-20.
- ¹⁸² Letter from NSW Health to Special Commission of Inquiry, 21 October 2008.
- ¹⁸³ Letter from NSW Health to Special Commission of Inquiry, 21 October 2008.
- ¹⁸⁴ Letter from NSW Health to Special Commission of Inquiry, 21 October 2008.
- ¹⁸⁵ Letter from NSW Health to Special Commission of Inquiry, 21 October 2008.
- ¹⁸⁶ Letter from NSW Health to Special Commission of Inquiry, 21 October 2008.
- ¹⁸⁷ Dr John Smoleniec, Liverpool hearing, 17 April 2008, transcript 1878.44-1879.4.
- ¹⁸⁸ Dr John Smoleniec, Liverpool hearing, 17 April 2008, transcript 1879.6-9.
- ¹⁸⁹ Marianne Levey, Liverpool hearing, 17 April 2008, transcript 1894.30-1895.17.
- ¹⁹⁰ Dr Peter Collett, Liverpool hearing, 17 April 2008, transcript 1816.13; "Questionnaire results", produced during evidence of Peter Collett, SUBM.069.0223.
- ¹⁹¹ Dr Nicholas Stephenson, Wagga Wagga hearing, 22 April 2008, transcript 2019.15-21.
- ¹⁹² Professor Kathrine Brown, Wollongong hearing, 14 April 2008, transcript 1600.9-12.
- ¹⁹³ Professor Kathrine Brown, Wollongong hearing, 14 April 2008, transcript 1600.12-19.
- ¹⁹⁴ Confidential submission, 14 May 2008, SUBM.040.0106 at 1.
- ¹⁹⁵ Dr Thomas Karplus, Concord Hospital hearing, 24 April 2008, transcript 2111.8-16.
- ¹⁹⁶ Submission of David Rhodes, Hunter New England AHS Area Allied Health Committee, 29 May 2008, SUBM.049.0074 at 2.
- ¹⁹⁷ Submission of Dr Stephen Adelstein, The Royal College of Pathologists Australasia, SUBM.014.0121 at 4-5.
- ¹⁹⁸ Submission of Dr Nicholas Stephenson, 20 April 2008, SUBM.029.046 at 3-4.
- ¹⁹⁹ Gerard Jeffrey, Tamworth hearing, 25 March 2008, transcript 815.30-32.
- ²⁰⁰ Gerard Jeffrey, Tamworth hearing, 25 March 2008, transcript 819.12-22.
- ²⁰¹ Gerard Jeffrey, Tamworth hearing, 25 March 2008, transcript 819.19-22.
- ²⁰² Professor Kathrine Brown, Wollongong hearing, 14 April 2008, transcript 1600.9-40.
- ²⁰³ Dr Frances Gearon, Orange hearing, 18 March 2008, transcript 585.28-31.
- ²⁰⁴ Dr Frances Gearon, Orange hearing, 18 March 2008, transcript 585.36-40.
- ²⁰⁵ Confidential meeting, 7 April 2008.
- ²⁰⁶ Charles Alpen, Mudgee hearing, 20 March 2008, transcript 741.18-26.
- ²⁰⁷ Catherine Hawke, Tamworth hearing, 25 March 2008, transcript 808.28-36.
- ²⁰⁸ Catherine Hawke, Tamworth hearing, 25 March 2008, transcript 808.31-42.
- ²⁰⁹ Catherine Hawke, Tamworth hearing, 25 March 2008, transcript 808.33-44.
- ²¹⁰ Catherine Hawke, Tamworth hearing, 25 March 2008, transcript 809.10-17.
- ²¹¹ Submission of Dr Hamish Steiner, 26 May 2008, SUBM.053.0092 at 2.
- ²¹² Catherine Hawke, Tamworth hearing, 25 March 2008, transcript 806.1-4.
- ²¹³ Catherine Hawke, Tamworth hearing, 25 March 2008, transcript 806.6-9.
- ²¹⁴ Meeting with Professor Bruce Robinson (Dean, Faculty of Medicine, University of Sydney), Professor Peter Smith (Dean, Faculty of Medicine, University of NSW), Professor Neville Yeomans (Foundation Dean of Medicine, University of Western Sydney) and Associate Professor Victor Mossar (Associate Dean of Medicine, University of Notre Dame, Sydney), 13 August 2008.
- ²¹⁵ Meeting with Professor Bruce Robinson (Dean, Faculty of Medicine, University of Sydney), Professor Peter Smith (Dean, Faculty of Medicine, University of NSW), Professor Neville Yeomans (Foundation Dean of Medicine, University of Western Sydney) and Associate Professor Victor Mossar (Associate Dean of Medicine, University of Notre Dame, Sydney), 13 August 2008.
- ²¹⁶ Letter from NSW Health to Special Commission of Inquiry, 21 October 2008.

-
- 217 Information provided during visit to Walgett Aboriginal Medical Service on 9 May 2008.
- 218 Information provided during visit to Broken Hill Hospital on 7 May 2008.
- 219 Information provided during visit to Broken Hill Hospital on 7 May 2008.
- 220 Trevor Cocks, Wagga Wagga hearing, 22 April 2008, transcript 1935.28-30.
- 221 Trevor Cocks, Wagga Wagga hearing, 22 April 2008, transcript 1935.30-36.
- 222 NSW Health Briefing, 4 April 2008, transcript 102.29-35.
- 223 NSW Health, *Policy Directive: Medical Officers – Employment Arrangements in the NSW Public Health System*, PD2007_087, 22 November 2007 at 10.
- 224 NSW Government, *NSW Government Response to the Report of the Rural Health Implementation Coordination Group – NSW Health Rural Plan*, September 2002, at 5.
- 225 Hegney D and McCarthy A, “Job Satisfaction in Nurses in Rural Australia” (2000) 30 (7/8) *Journal of Nursing Administration* 347 at 349.
- 226 Hegney D and McCarthy A, “Job Satisfaction in Nurses in Rural Australia” (2000) 30 (7/8) *Journal of Nursing Administration* 347 at 349.
- 227 Hegney D and McCarthy A, “Job Satisfaction in Nurses in Rural Australia” (2000) 30 (7/8) *Journal of Nursing Administration* 347 at 349.
- 228 Hegney D and McCarthy A, “Job Satisfaction in Nurses in Rural Australia” (2000) 30 (7/8) *Journal of Nursing Administration* 347 at 349.
- 229 Hegney D and McCarthy A, “Job Satisfaction in Nurses in Rural Australia” (2000) 30 (7/8) *Journal of Nursing Administration* 347 at 350.
- 230 Haslam McKenzie F, *Attracting and Retaining Skilled and Professional Staff in Remote Locations*, July 2007, DK CRC Report 21, Desert Knowledge Cooperative Research Centre, Alice Springs at 1.
- 231 Haslam McKenzie F, *Attracting and Retaining Skilled and Professional Staff in Remote Locations*, July 2007, DK CRC Report 21, Desert Knowledge Cooperative Research Centre, Alice Springs at 1.
- 232 Haslam McKenzie F, *Attracting and Retaining Skilled and Professional Staff in Remote Locations*, July 2007, DK CRC Report 21, Desert Knowledge Cooperative Research Centre, Alice Springs at 2.
- 233 Mercer Human Resources Consulting, *Attraction and Retention of Health Care Professionals in Rural/Remote Areas: Final Report – NSW Department of Health*, 28 June 2007, Mercer Human Resources at 5.
- 234 Mercer Human Resources Consulting, *Attraction and Retention of Health Care Professionals in Rural/Remote Areas: Final Report – NSW Department of Health*, 28 June 2007, Mercer Human Resources at 2.
- 235 Mercer Human Resources Consulting, *Attraction and Retention of Health Care Professionals in Rural/Remote Areas: Final Report – NSW Department of Health*, 28 June 2007, Mercer Human Resources at 4.
- 236 Mercer Human Resources Consulting, *Attraction and Retention of Health Care Professionals in Rural/Remote Areas: Final Report – NSW Department of Health*, 28 June 2007, Mercer Human Resources at 5.
- 237 Mercer Human Resources Consulting, *Attraction and Retention of Health Care Professionals in Rural/Remote Areas: Final Report – NSW Department of Health*, 28 June 2007, Mercer Human Resources at 5.
- 238 Mercer Human Resources Consulting, *Attraction and Retention of Health Care Professionals in Rural/Remote Areas: Final Report – NSW Department of Health*, 28 June 2007, Mercer Human Resources at 5.
- 239 Mercer Human Resources Consulting, *Attraction and Retention of Health Care Professionals in Rural/Remote Areas: Final Report – NSW Department of Health*, 28 June 2007, Mercer Human Resources at 5.
- 240 Mercer Human Resources Consulting, *Attraction and Retention of Health Care Professionals in Rural/Remote Areas: Final Report – NSW Department of Health*, 28 June 2007, Mercer Human Resources at 4.

-
- 241 Mercer Human Resources Consulting, *Attraction and Retention of Health Care Professionals in Rural/Remote Areas: Final Report – NSW Department of Health*, 28 June 2007, Mercer Human Resources at 9.
- 242 Information provided during visit to Wyong Hospital on 10 March 2008.
- 243 Information provided during visit to Wyong Hospital on 10 March 2008.
- 244 Dr Dennis Smith, Broken Hill hearing, 7 May 2008, transcript 2635.16-21.
- 245 Dr Dennis Smith, Broken Hill hearing, 7 May 2008, transcript 2636.4-8.
- 246 Dr Dennis Smith, Broken Hill hearing, 7 May 2008, transcript 2636.16-25.
- 247 Dr Sally Torr, Bourke hearing, 9 May 2008, transcript 2723.38-27.
- 248 Dr Sally Torr, Bourke hearing, 9 May 2008, transcript 2724.2-12.
- 249 Dr Sally Torr, Bourke hearing, 9 May 2008, transcript 2725.22-33.
- 250 Dr Sally Torr, Bourke hearing, 9 May 2008, transcript 2725.40-42.
- 251 Submission of Rozlyn Norman, 26 March 2008, SUBM.074.0087 at 3.
- 252 Submission of Rozlyn Norman, 26 March 2008, SUBM.074.0087 at 3.
- 253 Ellysa Brennan, Bourke hearing, 9 May 2008, transcript 2718.37-43 and 2719.3-4.
- 254 Ellysa Brennan, Bourke hearing, 9 May 2008, transcript 2718.44-2719.1.
- 255 Ellysa Brennan, Bourke hearing, 9 May 2008, transcript 2719.3-5.
- 256 Haslam McKenzie F, *Attracting and Retaining Skilled and Professional Staff in Remote Locations*, July 2007, DK CRC Report 21, Desert Knowledge Cooperative Research Centre, Alice Springs at 2.
- 257 Submission of Associate Professor Martin Jones, 17 April 2008, SUBM.024.0190 at 3.
- 258 Submission of Associate Professor Martin Jones, 17 April 2008, SUBM.024.0190 at 3.
- 259 Dr Catherine Hawke, Tamworth hearing, 25 March 2008, transcript 809.19-23.
- 260 Submission of NSW Health, 14 April 2008, SUBM.075.0002 at 133.
- 261 Submission of NSW Health, 14 April 2008, SUBM.075.0002 at 133.
- 262 Dr Phillip Hungerford, Tamworth hearing, 25 March 2008, transcript 849.24-850.47
- 263 Dr Phillip Hungerford, Tamworth hearing, 25 March 2008, transcript 849.24-850.47
- 264 Dr Phillip Hungerford, Tamworth hearing, 25 March 2008, transcript 849.24-850.47
- 265 Dr Phillip Hungerford, Tamworth hearing, 25 March 2008, transcript 849.24-850.47
- 266 Dr Phillip Hungerford, Tamworth hearing, 25 March 2008, transcript 849.24-850.47
- 267 Submission of Dr Patrick Cregan, undated, SUBM.003.0218.
- 268 Submission of Dr Patrick Cregan, undated, SUBM.003.0218.
- 269 Submission of Dr Patrick Cregan, undated, SUBM.003.0218; Dr John Pardey, Nepean Hospital hearing, 8 April 2008, transcript 1426.7-14.
- 270 Dr John Pardey, Nepean Hospital hearing, 8 April 2008, transcript 1425.16-27.
- 271 Submission of Margaret Duguid & Jenny Crane, 25 March 2008, SUBM.004.0142 at 0152
- 272 Information provided during visit to Bloomfield Hospital on 17 March 2008.
- 273 Information provided during visit to Bloomfield Hospital on 17 March 2008.
- 274 Information provided during visit to Bloomfield Hospital on 17 March 2008; Information provided during visit to Wilcannia MPS on 8 May 2008.
- 275 Information provided during visit to Bloomfield Hospital on 17 March 2008.
- 276 Information provided during visits to Bourke District Hospital on 9 May 2008 and Walgett District Hospital on 9 May 2008.
- 277 Information provided during visit to Walgett District Hospital on 9 May 2008.
- 278 Information provided during visit to Chisholm Ross Centre on 16 April 2008.
- 279 Susan Fowler, Wagga Wagga hearing, 22 April 2008, transcript 1977.4-13.
- 280 Dr Rodney Juratowitch, Wagga Wagga hearing 22 April 2008, transcript 1980.33.

-
- 281 Submission of Dr Gerard Carroll, 22 April 2008, SUBM.022.0063 at 63-64.
- 282 Confidential submission, 27 March 2008, SUBM.005.0032 at 33; Submission of Richard Torbay MP, 18 March 2008, SUBM.015.0121 at 132; Cr Allan Smith, Dubbo hearing, 19 March 2008, transcript 626.8, 629.5-7; Submission of Cr Allan Smith, 19 March 2008, SUBM.005.0023 at 27; Submission of Dr Louis Christie (C/- Australian Medical Association (NSW) and Australian Salaried Medical Officers Federation (NSW)), 28 March 2008, SUBM.016.0104 at 104.
- 283 Confidential submission, 25 March 2008, SUBM.009.0150 at 154.
- 284 Confidential submission, 25 March 2008, SUBM.009.0150 at 155.
- 285 Confidential submission, 18 December 2007, SUBM.005.0016.
- 286 Confidential submission, 22 March 2008, SUBM.005.0018.
- 287 Confidential submission, 8 September 2006, SUBM.005.0032 at 33.
- 288 Information provided during visit to Bellinger River District Hospital, 26 March 2008.
- 289 Desmond Ireland, Tweed hearing, 29 April 2008, transcript 2325.28.
- 290 Dr Jennifer Chambers, 27 March 2008, SUBM.022.0093 at 93.
- 291 Kathryn Hodgman, Port Macquarie hearing, 28 March 2008, transcript 1106.37.
- 292 Information received on a visit to Kempsey Hospital on 27 March 2008.
- 293 Kathryn Hodgman, Port Macquarie hearing, 28 March 2008, transcript 1107.5.
- 294 Dr Jennifer Chambers, Port Macquarie hearing, 28 March 2008, transcript 1079.13.
- 295 Submission of Dr Ian Cameron, NSW Rural Doctors Network, 25 March 2008, SUBM.003.0012 at 18.
- 296 Confidential Bourke hearing, 9 May 2008, transcript 5.2-5.
- 297 Confidential Bourke hearing, 9 May 2008, transcript 4.33-34.
- 298 Judith Johnson, Bourke hearing, 9 May 2008, transcript 2701.42-2702.1.
- 299 Confidential Bourke hearing, 9 May 2008, transcript 4.28-30.
- 300 Information provided during visit to Bourke District Hospital, 8 May 2008.
- 301 Mary-Louise Davis, Bourke hearing, 9 May 2008, transcript 2681.36-47.
- 302 Mary-Louise Davis, Bourke hearing, 9 May 2008, transcript 2681.46-2682.5.
- 303 Peter Tognetti, Bourke hearing, 9 May 2008, transcript 2713.29-37.
- 304 Submission of Dr W Ian Cameron, NSW Rural Doctors Network, 25 March 2008, SUBM.003.0012 at 18-20.
- 305 Judith Johnson, Bourke hearing, 9 May 2008, transcript 2701.32-36.
- 306 Vera Honeyman, Bourke hearing, 9 May 2008, transcript 2711.4-12.
- 307 Vera Honeyman, Bourke hearing, 9 May 2008, transcript 2711.32-37.
- 308 Mary-Louise Elizabeth Davis, Bourke hearing, 9 May 2008, transcript 2682.13-21.
- 309 Judith Ruth Johnson, Bourke hearing, 9 May 2008, transcript 2704.14-26.
- 310 Confidential Bourke hearing, 9 May 2008, transcript 3.39-42.
- 311 Confidential Bourke hearing, 9 May 2008, transcript 5.2-6.
- 312 Confidential Bourke hearing, 9 May 2008, transcript 5.38-6.2.
- 313 Information provided during visit to Macksville Hospital on 27 March 2008.
- 314 Paul Mesher, Port Macquarie hearing, 28 March 2008, 1076.18-34.
- 315 Margaret Mackenzie, Mudgee hearing, 20 March 2008, transcript 759.9.
- 316 Confidential Wollongong hearing, 14 April 2008, transcript 14.15. An inpatient CNC2 position at Shellharbour has been vacant since November 2007; a NUM in Eloura East has been vacant since January 2008; a CNC3 for senior person's mental health has been vacant since January; a team leader in Nowra retired in February; a CNC2 in the child and adolescent team has been vacant for over 12 months. One community nurse works 3 days a week and is carrying a caseload of 40 because of the resignation of one staff member. An

acceptable caseload would be about 20 patients, made up of 10 acute, 5 weekly and 5 fortnightly or monthly patients.

- 317 Submission of Associate Professor Martin James, 17 April 2008, SUBM.024.0190 at 192-3.
- 318 NSW Department of Health, *Rural Mental Health Emergency and Critical Care Access Plan*, June 2006, http://www.health.nsw.gov.au/pubs/2006/rural_mental_health.html (5 November 2008), p. 8.
- 319 NSW Health Briefing, 21 April 2008, presentation at 16, DOH.057.0229.
- 320 Mary-Louise Davis, Bourke hearing, 9 May 2008, transcript 2677.12-27.
- 321 Dr Geoffrey Hawkesford, Armidale hearing, 26 March 2008, transcript 917.44; David Erskine, Queanbeyan hearing, 15 April 2008.
- 322 Information provided during visit to Muswellbrook Hospital on 25 March 2008.
- 323 Dr Ronald Hawkesford, Armidale hearing, 26 March 2008, transcript 917.36-47. Armidale does not have an on-site after hours psychiatric service. Whilst there is an inpatient unit at Armidale, it is not for scheduled patients, who have to be transported by ambulance with police escort to Tamworth.
- 324 Dr Phillip Hungerford, Tamworth hearing, 25 March 2008, transcript 851.05.
- 325 Mary-Louise Davis, Bourke hearing, 9 May 2008, transcript 2674.39-2678.04. This is difficult because the Dubbo Patient Flow Unit closes at 8pm.
- 326 Confidential Bourke hearing, 9 May 2008, transcript 13.42-15.04.
- 327 Mary-Louise Davis, Bourke hearing, 9 May 2008, transcript 2687.27-2688.11; James Loneragon, Mudgee hearing, 20 March 2008, transcript 706-707.8.
- 328 Section 27 of the *Mental Health Act 2007* requires an authorized medical officer to examine a detained person as soon practicable, and within 12 hours, after their detention and if, in the officer's opinion, the person is a mentally ill person or a mentally disordered person, a second medical practitioner (who must be a psychiatrist if the first medical officer was not) must examine the person as soon as possible and form an opinion as to whether that person is mentally ill or mentally disordered.
- 329 Information provided during visit to Wilcannia MPS on 8 May 2008.
- 330 Section 4, *Mental Health Act 2007* (NSW).
- 331 Information provided during visit to Wilcannia MPS on 8 May 2008.
- 332 David Erskine, Queanbeyan hearing, 15 April 2008, transcript 1726.9-1726.11; Janice Dubavs, Queanbeyan hearing, 15 April 2008, transcript 1774.33-1774.44.
- 333 Note of meeting with Dr Adrian Keller, Royal Australian and New Zealand College of Psychiatrists on 25 June 2008.
- 334 Letter from NSW Health to Special Commission of Inquiry, 24 October 2008.
- 335 NSW Health Briefing, 21 April 2008, presentation at 248, DOH.057.0229
- 336 Letter from NSW Health to Special Commission of Inquiry, 24 October 2008.
- 337 Submission of Dr Andrew Munro, 27 March 2008, SUBM.027.0441 at 442.
- 338 Carolyn Podger, Tweed Heads hearing, 29 April 2008, transcript 2362.10; Michael Shnukal & Joseph Lockley, Tweed Heads hearing, 29 April 2008, transcript 2350.11-19. The unit runs at 96% occupancy and has ranged from 88% to 104% (transcript 2352.35).
- 339 Charlene Brown, Wagga Wagga hearing, 22 April 2008, transcript 2032.11-32.
- 340 NSW Department of Health, *Rural Mental Health Emergency and Critical Care Access Plan*, June 2006, http://www.health.nsw.gov.au/pubs/2006/rural_mental_health.html (5 November 2008), p. 5.
- 341 Margaret Bramwell, Royal North Shore Hospital hearing, 2 April 2008, transcript 1308.34-45. Phillip Hodges, Tamworth hearing, 25 March 2008, transcript 856.12. Information provided during visit to Cumberland Psychiatric Hospital on 13 May 2008.
- 342 Ann White, Dubbo hearing, 19 March 2008, transcript 663.19-29. Confidential Armidale hearing, 26 March 2008, transcript 4.07-33. Richard Western, Broken Hill hearing, 7 May 2008, transcript 2623.18. Information provided during visit to Wellington Aboriginal Medical Service, 18 March 2008. Submission of Margaret Mauro, 19 March 2008, SUBM.012.0208.

- 343 Submission of Fran Hodgson, 12 May 2008, SUBM.042.0314 at 314-315.
- 344 Fran Hodgson, John Hunter Hospital hearing, 12 May 2008, transcript 2808.30.
- 345 Harry Bolton, Armidale hearing, 26 March 2008, transcript 904.13.
- 346 Kathleen Gradidge, Nepean Hospital hearing, 8 April 2008, transcript 1468.15-1469.17.
- 347 Kathleen Gradidge, Nepean Hospital hearing, 8 April 2008, transcript 1468.15-1469.17.
- 348 James Loneragon, Mudgee hearing, 20 March 2008, transcript 708.10-18.
- 349 Roger Parker, Dubbo hearing, 19 March 2008, transcript 682.9-14. Submission of Fran Hodgson, 12 May 2008, SUBM.042.0314 at 314-315.
- 350 Judith Johnson, Bourke hearing, 9 May 2008, transcript 2703.32-2704.08.
- 351 Richard Western, Broken Hill hearing, 7 May 2008, transcript 2622.37-2623.11.
- 352 Information provided during visit to Walgett Aboriginal Medical Service on 9 May 2008.
- 353 NSW Health Briefing, 31 March 2008, transcript 16.07-24.
- 354 Submission of Christopher Stephens, 20 March 2008, SUBM.014.0373 at 373-374.
- 355 Submission of Adrian Piccoli, MP, 7 April 2008, SUBM.013.0147 provides an example of where transport arrangements for follow-up appointments are difficult.
- 356 Submission of Fran Hodgson, 12 May 2008, SUBM.042.0314 at 315.
- 357 Information provided during visit to Walgett Aboriginal Medical Service on 9 May 2008.
- 358 Information provided during visit to Walgett Aboriginal Medical Service on 9 May 2008.
- 359 Information provided during visit to Walgett Aboriginal Medical Service on 9 May 2008.
- 360 Information provided during visit to Walgett Aboriginal Medical Service on 9 May 2008.
- 361 Confidential Coffs Harbour hearing, 27 March 2008.
- 362 NSW Health Briefing, 22 May 2008, transcript 4.11 and presentation at 6.
- 363 Vera Honeyman, Bourke hearing, 9 May 2008, transcript 2711.37.
- 364 Vera Honeyman, Bourke hearing, 9 May 2008, transcript 2711.43-2712.05; Richard Western, Broken Hill hearing, 7 May 2008, transcript 2623.18; Submission of Christopher Stephens, 20 March 2008, SUBM.014.0373 at 373-374.
- 365 Information provided during visit to Walgett Aboriginal Medical Service on 9 May 2008.
- 366 Submission of Christopher Stephens, 20 March 2008, SUBM.014.0373 at 374.
- 367 Senate Standing Committee on Community Affairs, The Senate, Commonwealth of Australia, *Highway to Health: Better Access for Rural, Regional and Remote Patients*, September 2007, Canberra at 39.
- 368 Vera Honeyman, Bourke hearing, 9 May 2008, transcript 2711.43-2712.05.
- 369 Submission of Councillor Greg Matthews, 25 March 2008, SUBM.012.0176 and SUBM.045.0062 at 080, 087 and Appendix 2.
- 370 Submission of Councillor Greg Matthews, 25 March 2008, SUBM.012.0176 and SUBM.045.0062 at 080, 087 and Appendix 2; Confidential submission, 27 March 2008, SUBM.005.0001 at Attachment 2 (SUBM.005.0011).
- 371 NSW Health, *Transport for Health – Isolated Patient Travel & Accommodation Assistance Scheme Administration Manual*, PD2007_069 at 22. Richard Western, Broken Hill hearing, 7 May 2008, transcript 2623.18.
- 372 Fran Hodgson, John Hunter hearing, 12 May 2008, transcript 2809.27.
- 373 Senate Standing Committee on Community Affairs, The Senate, Commonwealth of Australia, *Highway to Health: Better Access for Rural, Regional and Remote Patients*, September 2007, Canberra at 69.
- 374 Senate Standing Committee on Community Affairs, The Senate, Commonwealth of Australia, *Highway to Health: Better Access for Rural, Regional and Remote Patients*, September 2007, Canberra, Recommendation 7 at 10.
- 375 NSW Health Briefing, 22 May 2008, transcript 6.11-25. NSW Health, *Transport for Health – Isolated Patient Travel & Accommodation Assistance Scheme Administration Manual*, PD2007_069.

- 376 NSW Health, *Transport for Health*, PD2006_068.
- 377 David White, Goulburn hearing, 16 April 2008, transcript 1806.25-33. NSW Health Briefing, 22 May 2008, transcript 6.11-25.
- 378 NSW Health website, <http://www.health.nsw.gov.au/initiatives/iptaas/index.asp>. Thomas George MP, Lismore hearing, 28 April 2008, transcript at 2210.35-2211.13. NSW Health, *Transport for Health – Isolated Patient Travel & Accommodation Assistance Scheme Administration Manual*, PD2007_069.
- 379 Thomas George MP, Lismore hearing, 28 April 2008, transcript at 2210.35-2211.13.
- 380 Letter from NSW Health to Catherine Follent, Special Commission of Inquiry, 10 September 2008 (Request 45).
- 381 Dr Stephen Flecknoe-Brown, Broken Hill hearing, 7 May 2008, transcript 2665.36.
- 382 NSW Health, *Transport for Health – Isolated Patient Travel & Accommodation Assistance Scheme Administration Manual*, PD2007_069.
- 383 NSW Health Briefing, 22 May 2008, transcript 13.14-34. NSW Health, *Transport for Health – Isolated Patient Travel & Accommodation Assistance Scheme Administration Manual*, PD2007_069.
- 384 NSW Health Briefing, 22 May 2008, transcript 13.14-34. NSW Health, *Transport for Health – Isolated Patient Travel & Accommodation Assistance Scheme Administration Manual*, PD2007_069 at 28.
- 385 NSW Health, *Transport for Health – Isolated Patient Travel & Accommodation Assistance Scheme Administration Manual*, PD2007_069 at 25-28.
- 386 NSW Health Briefing, 22 May 2008, transcript 13.14-34.
- 387 Submission of Margaret Mauro, Combined Pensioners and Superannuants Association of NSW, 19 March 2008, SUBM.012.0207 and SUBM.012.0208.
- 388 Confidential Armidale hearing, 26 March 2008, transcript 5.30-40.
- 389 Dianne Johnson, Bourke hearing, 9 May 2008, transcript 2674.08.
- 390 Vera Honeyman, Bourke hearing, 9 May 2008, transcript 2712.13-27.
- 391 Senate Standing Committee on Community Affairs, The Senate, Commonwealth of Australia, *Highway to Health: Better Access for Rural, Regional and Remote Patients*, September 2007, Canberra at ix-x. Letter from NSW Health to Catherine Follent, Special Commission of Inquiry, 10 September 2008 (Request 45).



Special Commission of Inquiry

Acute Care Services in NSW Public Hospitals

Part B

Workforce

7 Doctors

Types of doctors	188
Interns.....	188
Residents.....	189
Registrars	189
CMOs.....	189
Hospitalists	190
Visiting Medical Officers	191
Staff Specialists	192
General Practitioners.....	192
Specialists	193
Medical colleges	194
Do we have enough doctors?	197
Increase in medical graduates	199
The role of colleges in supply.....	202
Lack of generalists.....	203
Working conditions	206
Workload	207
Lengthy hours of work	208
Remuneration	211
Locums	212
The problem with locums.....	213
Solutions.....	217
Overseas qualified doctors	221
What training is provided?.....	223
A bit of understanding.....	224
Performance management	225
Contractual arrangements with medical staff	225
Recommended improvements to the performance appraisal system.....	227
Clinical leaders	228

Types of doctors

- 7.1 In New South Wales, there were 28,928 registered medical practitioners in June 2007.¹
- 7.2 37.5% of New South Wales medical practitioners are GPs, 35.8% are specialists, 16.3% are hospital non-specialists and 10.5% are training to be specialists. 58% of the NSW Health medical workforce are over 43 years old and 85-90% work in a metropolitan area.² Data indicates that approximately 56% of hours worked by doctors are in the private sector and 38% are in the public sector.³
- 7.3 At June 2007, NSW Health employed 7,318 full time equivalent doctors and engaged an additional 4,677 Visiting Medical Officers.
- 7.4 The following table provides an overview of recent numbers of medical officers in the public hospital system by categories.

Medical officer designations	FTE Numbers (as at June 2008)
Visiting medical officers (headcount)	4,677 ⁴
Staff specialists	2463 ⁵
Career medical officers	388
Registrars	2,663
Resident medical officers	1324
Interns	584
Locums ⁶	281 ⁷

- 7.5 Specialist doctors, accredited to a hospital or hospitals, may have admitting rights to one or more hospitals as defined in their contract of employment. Specialist doctors may either be remunerated on a sessional or fee for service basis (Visiting Medical Officers) or be salaried employees of the hospital (Staff Specialists). Visiting Medical Officers have rights to private practice. Staff Specialists may also have rights to private practice depending on their area of specialty.
- 7.6 There are many types of doctors working within the NSW public health system, and the titles can be confusing. It may be helpful, at the outset, to describe the various types and the training required for each.

Interns

- 7.7 Interns are doctors in Postgraduate Year 1 (**PGY1**) who must complete supervised rotations in medicine, surgery and emergency to meet conditions for full registration with the NSW Medical Board. Rotations are generally 10 to 11 weeks in duration. Since the beginning of 2008, interns are appointed to a 2 year position in a network, not an individual hospital. Hospitals must meet accreditation standards set by the Institute of Medical Education and Training in relation to supervision and education.
- 7.8 Interns' salaries are prescribed by the Health Professional and Medical Salaries (State) Award.
- 7.9 There are 584 interns working in NSW public hospitals.⁸ Medical graduates are set to more than double between 2007 and 2014, meaning that the number of interns is soon to increase significantly. I address this issue further below.

Residents

- 7.10 Resident Medical Officers are doctors in Postgraduate Year 2 (**PGY2**) or 3 (**PGY3**) with full medical registration. Doctors in PGY2 undertake 5 supervised terms of 10 to 11 weeks across a number of medical specialties.
- 7.11 Some doctors enter specialty training programs in PGY3 and continue as registrars in PGY4 to PGY8. Others continue in PGY3 in non-accredited training positions as residents.
- 7.12 Within the medical profession, the term Junior Medical Officer can refer to all doctors who are not specialists – that is, interns, resident medical officers, registrars, Career Medical Officers and Hospitalists.⁹ However, in other situations (including in this report), the term Junior Medical Officer refers to doctors in their first 2 postgraduate years, that is interns and residents.

Registrars

- 7.13 Registrar is the term used to describe doctors who are enrolled in basic or advanced training with a specialist medical College.¹⁰ Training positions are offered by individual hospitals or hospital networks which have met accreditation criteria set by Colleges.
- 7.14 Generally, registrars are in postgraduate year 3 as a minimum (**PGY3**). Like interns and residents, registrars are usually rotated among different service units in hospitals. They are required to meet College criteria for training, including regular supervisor reports, and sit examinations administered by the relevant College. The duration of training is dependent on individual College training programs. Generally, registrars in PGY5 or above are 'senior registrars' and acquire considerable autonomous clinical responsibility, including for supervision of junior doctors.
- 7.15 About 10.5% of New South Wales doctors are registrars (that is, specialists in training). The typical specialist in training is male (56.9%), 33.4 years of age, working in the public sector (88%) in a metropolitan area (92.2%).¹¹
- 7.16 There are 2,459 registrars working in NSW public hospitals.¹² Like interns and residents, registrars are covered by the Health Professional and Medical Salaries (State) Award and the Public Hospital (Medical Officers) Award.

CMOs

- 7.17 Career Medical Officers (CMO) are long term non-specialist doctors. They are employed in the public hospital system, on a salaried basis and do not have admitting rights. Career Medical Officers are also known as Multi-skilled medical officers (MMOs). They have sufficient experience to practise with little or no supervision.¹³ The CMO workforce is diverse in terms of seniority and competence.
- 7.18 Career Medical Officers are employed under the Public Hospital Career Medical Officers (State) Award. That award provides for a grade of Senior CMO for those Career Medical Officers with at least 7 years experience. It also provides paid leave of 7 days per annum for all grades of CMO for the purposes of Continuing Medical Education and professional development.¹⁴ There is anecdotal evidence that hospitals utilising the new award to employ Career Medical Officers have minimised the use and cost of locums.¹⁵ Some Career Medical Officers, however, themselves take positions as locums.

- 7.19 NSW Health and the Institute of Medical Education and Training are attempting to develop a career structure for Career Medical Officers by:
- developing a training program, the Hospital Skills Program, to be delivered by the Institute of Medical Education and Training;
 - creating a new position known as Staff Hospitalist and a dedicated training program to support this role.
- 7.20 The Hospital Skills Program includes a special curriculum for doctors working in Emergency Departments. The development of the Hospital Skills Program was initiated following a review of the delivery of emergency medicine training in NSW in 2005 by IMET which found that nearly 50% of emergency medicine registrar positions in accredited Emergency Departments were occupied by non-specialist medical workforce.¹⁶ The program aims to recognise, maintain and enhance the skills of the current and future non-specialist medical workforce working in Emergency Departments.¹⁷ It is not, however, limited to non-specialist doctors working in Emergency Departments.
- 7.21 In my view, the success of the Hospital Skills Program is of great importance. It is said, and I accept, that it will assist in raising the profile and capacities of many doctors who choose not to specialise, and in attracting doctors who at present opt to work as locums to work in the public system as permanent staff.¹⁸ It will assist in engaging them in a much more positive and productive way and, in the process, improve the quality of general care in public hospitals. One way to attract Career Medical Officers to the training program is to link progression through the pay scales with progression through the training program.
- 7.22 The Inquiry received submissions that, despite the award provision, area health services often refuse to provide Career Medical Officers with paid leave for professional development and to reimburse associated expenses, as required.¹⁹ This is unfortunate and should not happen given the entitlements of Career Medical Officers under the award. I was also told that the process to become a Senior CMO is difficult and drawn out.²⁰ Again, this is unfortunate and is an unnecessary barrier to the encouragement of more generalists within the hospitals and the health system. I return to this question below.

Hospitalists

- 7.23 Hospitalists are Career Medical Officers by another name. The role of Hospitalist was first introduced in January 2007 under pilot programs operating in 11 hospitals. This role is for doctors who do not want to become specialists, but wish to increase their skills across a number of speciality areas.²¹ The focus of the position is to provide quality clinical care to ensure the care of the patient is coordinated and as effective, efficient and as safe as possible.
- 7.24 Currently, Hospitalists are located at Ryde Hospital (3), Mona Vale Hospital (1), Sydney Children's Hospital (3), Westmead Hospital (2), the Children's Hospital at Westmead (1) and Royal North Shore Hospital (1).
- 7.25 In the hospitals in which they work, Hospitalists appeared to me to be highly regarded as experienced doctors who tended to work at a particular hospital for the long term. This provided other staff with someone to go to with questions which need continuity and experience to answer. The Hospitalist at Ryde Hospital described his role as being that of "an advanced clinical troubleshooter" who assists in the "middle parts of the system", with no admitting rights.²² He explained to me that one of the major assets a Hospitalist can provide to a hospital is his or her corporate memory.

- 7.26 Another Hospitalist told me that he detected a fear among other doctors that Hospitalists would eventually obtain admitting rights.²³ The Royal Australasian College of Physicians told the Inquiry that it supports the role on the condition that Hospitalists remain junior to consultants (that is specialists) and remain guided by consultants.²⁴ At the consultant level, I was told that doctors should be qualified general physicians (that is, fellows of the College), not Hospitalists.²⁵ Similarly, the Australian Medical Association and Australian Salaried Medical Officers Federation support the role of Hospitalist subject to recognition of the principle of equitable and timely access to specialist-led care.²⁶
- 7.27 As noted above, there is soon to be created a new position of Staff Hospitalist and a corresponding training program. It is intended to be a more senior grade than the current Senior Career Medical Officer and the most senior position in a career pathway for hospital non-specialist doctors.²⁷ The Hospital Skills Program is intended to support the skills of non-specialist doctors working in public hospitals.
- 7.28 I support these initiatives because:
- Hospitalists have an important role in co-ordinating the care of a patient who has needs which cross the boundaries of individual specialties;
 - These initiatives aim to enhance the quality of general care provided in public hospitals by providing greater availability and consistency in medical services;
 - A formal career structure for hospital non-specialists will assist in attracting and retaining permanent staff and enhance the stability of the senior medical workforce;
 - The creation of new roles and training for senior non-specialist doctors provides those doctors with recognition for their contribution;
 - Standardising education and training should also improve consistency in medical services. The success of the Hospital Skills Program will encourage doctors to enhance their qualifications.
- 7.29 The Hospitalist seems to me to be an excellent model which should be expanded into more hospitals across NSW. In particular, I see a need for Hospitalists in rural and major regional centres because of the shortage of doctors who can provide general care.

Visiting Medical Officers

- 7.30 A Visiting Medical Officer is a medical practitioner appointed under a service contract to provide services for and on behalf of a public health organisation. A Visiting Medical Officer therefore functions as an independent contractor, not an employee. Most Visiting Medical Officers are specialists. In rural areas, however, GPs are often appointed as Visiting Medical Officers in fields such as general medicine, obstetrics and general surgery.
- 7.31 Visiting Medical Officers usually have admitting rights and on-call responsibilities. As they are not employees, the remuneration of Visiting Medical Officers is calculated either by reference to a scale of fees for different kinds of medical services or to an hourly rate, depending on the type of service contract.
- 7.32 At June 2006/2007, there were 4,677 Visiting Medical Officers in New South Wales²⁸. I was told by NSW Health that on average Visiting Medical Officers spend about 10 hours per week working in the public health system.²⁹
- 7.33 Visiting Medical Officers are appointed on fixed 3 or 5 year contracts.

Staff Specialists

- 7.34 Staff specialists are employed by the hospital rather than under service contracts. Staff specialists have the right to conduct a private practice.
- 7.35 Many Staff Specialists hold conjoint appointments with a public health organisation and a university and are required to teach medical students, train junior doctors, conduct research and/or supervise postgraduate research, as the case may be.
- 7.36 At June 2007, there were 2370.4 FTE Staff Specialists in New South Wales public hospitals.³⁰

General Practitioners

- 7.37 Roughly a third of NSW doctors are GPs (37.5%).³¹ A typical NSW GP is male (64%), 52.9 years old, working in private rooms (84%) in a metropolitan area (81.3%).
- 7.38 At the present time, about 24% of local medical graduates become GPs. Their numbers are supplemented by overseas trained doctors.³²
- 7.39 To the extent that they receive government funding, GPs are funded by the Commonwealth Government through the Medicare Benefits Schedule (**MBS**).
- 7.40 The availability of GPs has ramifications for doctors working in acute care hospitals in two main ways:
- (a) A lack of GPs in the community puts more pressure on Emergency Departments. I discuss this issue in Chapter 20.
 - (b) In outer metropolitan and rural areas, GPs also provide medical services in hospitals through VMO arrangements. From what I have observed the availability of GPs in rural communities is fundamental to the availability of acute care services in rural hospitals.

VMO GPs

- 7.41 The work undertaken by a GP VMO at a public hospital providing acute care is determined by the clinical privileging process. Clinical privileges represent the range and scope of clinical responsibility that a professional may exercise in a particular facility, having regard to their credentials, skills and competencies.
- 7.42 As at June 2007, approximately 870 rural GPs held appointments as VMOs in almost 150 public hospitals in rural New South Wales.³³ The number of GPs with VMO appointments in rural areas has fallen substantially in recent years. This has implications for the availability of acute medical and procedural services in rural areas.
- 7.43 The role of rural or remote GPs is often broader than that of their urban counterparts due to a lack of nearby specialists. Rural GPs may provide procedural services in public hospitals within the clinical privileges which the hospital grants. In NSW, there are known to be 84 GPs who may administer anaesthetics, 113 who may deliver babies in a normal delivery, 56 who can perform surgery. A GP may be entitled to perform more than one of these tasks, for example, obstetrics and surgery.³⁴ The national minimum dataset, first collected in 2001, shows a decline in the number of GP proceduralists performing anaesthetics, obstetrics and surgery.
- 7.44 I was told that the number of GPs providing procedural services in New South Wales hospitals is declining rapidly, due to an ageing workforce, workforce shortages, and lack

of support and encouragement for rural GPs to begin or continue providing procedural services.³⁵ It is said that poor maintenance and closures of operating theatres and lack of necessary equipment are also contributing factors.

- 7.45 It was submitted to the Inquiry that there is a need to introduce training and professional development opportunities for GP VMOs, as well as overseas trained doctors, particularly in rural areas where they are a central component in the delivery of acute care services.³⁶ I see much force in this submission. I discuss overseas trained doctors below. In my view, the newly created Hospital Skills Program should be extended to include GP VMOs working in New South Wales public hospitals.

GP CMOs

- 7.46 General practitioners may also be employed in a public hospital as Career Medical Officers. These appointments are most commonly made in the metropolitan area.
- 7.47 In contrast to doctors in training (such as residents) who undertake a series of terms in a range of areas, Career Medical Officers often hold the same position within the one public health service for an extended period of time. They develop a corporate knowledge which, I was told, is of great value to the hospital or ward in which they work.³⁷
- 7.48 While traditionally wards rely heavily on nursing staff and senior doctors to provide some continuity within the hospital, I was told that there is benefit in having Career Medical Officers develop a career in a particular area of medical practice, as they not only deepen their skills, but help to preserve the continuity of knowledge within a hospital or ward. There is a range of benefits to be gained from hospital-based medical officers having corporate knowledge, not least the efficiencies which flow from their familiarity with the local processes and protocols.

Specialists

- 7.49 Specialists account for more than a third of the total medical workforce.³⁸ About 6,880 specialists work in the NSW public health system, almost all in acute care services.³⁹ A typical NSW specialist is male (78.5%), 52 years old, working in private rooms (54.3%) in a metropolitan area (88.8%).⁴⁰
- 7.50 Specialist training requires an enormous commitment in time and money: it may take up to 17 years after leaving high school to become a specialist.
- 7.51 Specialists practise as Visiting Medical Officers, Staff Specialists or clinical academics. Historically some specialties are staffed solely or mainly by Staff Specialists, including emergency medicine, psychiatry and geriatrics. Specialists are also called consultants.
- 7.52 Several submissions to the Inquiry argued that there should be more Staff Specialists in public hospitals who would form the backbone of service delivery, with Visiting Medical Officers augmenting this core of employed clinicians.⁴¹ It is said that this would permit patients to be seen without delays, provide greater continuity of care and allow for better supervision and training of junior medical officers. Of course, this begs the question as to the areas in which an increased number of Staff Specialists would work. More Staff Specialist surgeons would be likely to create a need for more outpatient facilities for seeing patients pre and post-operatively. There needs to be an appropriate balance of Visiting Medical Officers and Staff Specialists working in public hospitals to ensure that public hospitals provide the right mix of clinical service provision, supervision and teaching and opportunities for research.

- 7.53 According to annual surveys carried out by NSW Health, specialists work more in the private sector than they do in the public hospitals of NSW. A *Profile of the Medical Workforce, 2005* identified that 54.3% of specialists reported working mainly in the private sector.⁴² The *Profile of the Medical Workforce, 2006* reported that 38% of total hours worked by specialists were delivered through the NSW public health system.⁴³
- 7.54 The fact that many specialists work in both the public and private sectors poses challenges to NSW public hospitals. This seems to have a lot to do with the time a specialist is able to dedicate to the public hospital. I was told that some Staff Specialists overexploit their right to treat private patients and are not sufficiently available to carry out public patient work.⁴⁴ On the other hand, according to the Australian Medical Association and the Australian Salaried Medical Officers' Federation, whilst Staff Specialists have a right of private practice, more than half earn little or no private practice income.⁴⁵
- 7.55 Visiting medical officers are said by some to be uncommitted to the public system, given the better conditions available in the private sector. One witness stated:⁴⁶
- "We have had a couple of our senior surgeons go from being VMOs to full-time staff specialists. What a difference it has made ... because they are always there. They don't just come in once or twice a week. They give really excellent care. They are there to talk to [carers] at any time. They are there to teach. They are there to support us - it's a totally different service."
- 7.56 As the bulk of the VMOs work is outside the public system, I heard a criticism in some quarters that their public hospital work plays second fiddle to the demands of their private practices. In particular, the co-operation of VMOs in flexible rostering of their time of visiting public patients was greatly to be desired. The habit of doing rounds and discharging patients in the early evening was cited as a not insignificant contributor to access block. A morning round could clear patients ready for discharge by the afternoon. A later afternoon or early evening round usually meant that patients who were ready to go home could not be discharged until the next day.
- 7.57 On the other hand, I was told that, while Visiting Medical Officers may not be available at every moment, they are efficient.⁴⁷
- 7.58 It is an accepted feature of the VMO workforce that they provide services at a range of facilities both inside and outside the public sector. Yet, I was told that area health services do not do enough to engage VMOs or communicate with them. One example is that they are not given access to hospital internets. Despite the fact that they work under different contractual arrangements, in my view it is essential that the public hospital system treat VMOs on the same footing as other staff when it comes to communication.
- 7.59 There are two other types of doctors which warrant special discussion, and I have dealt with them below: locums and overseas trained doctors.

Medical colleges

- 7.60 Before passing to some of the issues which confront NSW public hospitals in relation to doctors, it is helpful to outline the role of medical colleges.
- 7.61 Specialist training in Australia is organised, supervised and examined by a medical college. The colleges have multiple functions including:

- (a) selecting medical graduates for specialist training, and providing training and assessing trainees, including by administering written and clinical examinations;
- (b) assessing applications from specialists trained overseas who wish to practise in Australia;
- (c) accrediting hospitals for training positions;
- (d) on completion of the college's training, issuing a fellowship or other certification attesting to the attainment or maintenance of appropriate levels of skills, knowledge and competencies appropriate to specialist practice;
- (e) providing continuing professional education and other educational opportunities for fellows;
- (f) representing fellows' interests in various forums, including to government bodies and other organisations.

7.62 It is not one of the functions of the Colleges to discipline its members. Disciplinary matters are within the realm of the Medical Board of New South Wales. Apart from the ability to expel them on specified grounds, such as serious misconduct, Colleges do not have legal authority over their members.⁴⁸

7.63 There are 14 colleges:

- Australian and New Zealand College of Anaesthetists
- The Royal Australasian College of Dental Surgeons
- The Australasian College of Dermatologists
- Australasian College for Emergency Medicine
- The Royal Australian College of General Practitioners
- Royal Australasian College of Medical Administrators
- The Royal Australian and New Zealand College of Obstetricians and Gynaecologists
- The Royal Australian and New Zealand College of Ophthalmologists
- The Royal College of Pathologists of Australasia
- The Royal Australasian College of Physicians
- The Royal Australian and New Zealand College of Psychiatrists
- The Royal Australian and New Zealand College of Radiologists
- Australian College of Rural and Remote Medicine
- Royal Australasian College of Surgeons

7.64 Some colleges have established faculties or divisions for sub-specialities, some of which are independent bodies offering their own vocational training programs. The training and education programs of the Colleges are accredited by the Australian Medical Council and in the case of the 11 two-nation colleges, the Medical Council of New Zealand to ensure they meet appropriate standards. Training is delivered by fellows of the Colleges, without payment. The trainees (registrars) are employed by the Department of Health.

7.65 Every college has guidelines about a broad range of matters relating to patient care, such as training, equipment issues, staffing levels, safe practices, supervision and assistant skills, to name a few. Colleges inspect hospitals to see that their guidelines are being adhered to.

- 7.66 One of the main issues regarding Colleges that I heard about during the Inquiry was the tension between the Colleges' accreditation requirements for the training of registrars, the service requirements of hospitals, and the funding of those positions by government.
- 7.67 Whereas Colleges may on occasion threaten to withdraw accreditation from a hospital where they are of the view that standards at the hospital do not meet guidelines in a particular area, NSW Health laments the absence of accreditation where staff shortages at a hospital could helpfully be filled by registrars. On the other hand, numerous Colleges made submissions to the Inquiry that, in some areas of real need, accredited positions are not filled with registrars through no fault of the College but because of the government's reluctance to provide funding for the positions.⁴⁹ I was told that it is rare that a College withdraws accreditation from a hospital.⁵⁰
- 7.68 A review of the medical specialist colleges carried out by the Australian Competition and Consumer Commission, jointly with the Australian Health Workforce Officials Committee, in 2005 noted the following in relation to accreditation.⁵¹

"Accreditation allows for the review and monitoring of services, facilities, training programs etc., to ensure minimum requirements or standards are met and can be used as a mechanism to facilitate continuous quality improvement. An accreditation review is a mechanism for testing that policies and processes are in place, appropriate and are being applied. An accreditation process will also require evidence that infrastructure, equipment and resources are in place and that specified outcomes are being met. For medical colleges, these outcomes relate to the training of safe and competent specialists who are well prepared for independent practice."⁵²

Accredited training positions therefore should deliver quality education and training that is appropriate to prepare trainees for future independent practice. To achieve this, training should be provided across a broad range of educational and training experiences, in a range of training environments and be objectively assessed.

Accreditation standards for education and training programs would commonly incorporate criteria such as:

- role and skills required of trainees
- orientation requirements
- supervision requirements
- education program requirements
- education and information resources to be made available in the workplace
- access to clinical teachers and their roles and responsibilities
- assessment and feedback mechanisms, in particular management of poor performance
- service and training requirements
- medical administration of trainees
- issues related to safe practice
- communication and grievance mechanisms."

- 7.69 One of the recommendations of the ACCC review was that the Colleges' criteria for accrediting training networks for hospitals "need to be objective, measurable and related to training" and should be endorsed by jurisdictions.
- 7.70 There is undoubtedly an interest in the accrediting body being independent of government. The Inquiry received a lot of evidence to the effect that too frequently service delivery takes precedence over competing priorities such as training, supervision and education. Giving to one body both the responsibility for accreditation and the responsibility for delivering services would allow that body to change professional and accreditation standards to address workforce issues or achieve cost savings.

Do we have enough doctors?

- 7.71 It is not easy to answer this question. NSW Health does not yet have a single comprehensive database which is capable of identifying how many doctors it has working in its hospitals, or in which speciality. Nevertheless, the Inquiry received a large amount of evidence which shows that all area health services are experiencing challenges in recruiting suitably qualified doctors in some disciplines due to a general shortage and/or distributional issues. It is also apparent that the recruitment problems are not spread evenly across New South Wales. Rural and remote metropolitan areas, including the west and south-west of Sydney, are experiencing increased difficulty in attracting and retaining medical staff.⁵³
- 7.72 In terms of the available data about the number of doctors in New South Wales, the Medical Board of New South Wales provides the only good source of information across the public and private sector about the medical workforce. Registration data from the Board does not, however, reveal whether registered medical practitioners are currently practising.
- 7.73 To determine the true extent of the doctor shortage, it is necessary to know how many doctors are required for each area of specialty and where they are needed. There is no international standard identifying the appropriate number of medical practitioners generally or medical specialists specifically, per head of population. In New South Wales, there are no guidelines for medical staffing of public hospitals. Guidelines have been put forward for Emergency Departments, however they are currently the subject of considerable debate.⁵⁴
- 7.74 Hospitals throughout New South Wales use variable numbers and mixes of medical staff to meet their service requirements. Staffing levels generally reflect available resources rather than a 'correct' number or staffing profile from a clinical point of view.
- 7.75 The best data available on medical workforce shortages came from the Australian Medical Workforce Advisory Committee (**AMWAC**). AMWAC was abolished after the Productivity Commission's Health Workforce Report in 2005. AMWAC examined at least 24 medical workforces and found that there were existing or emerging shortages in doctor numbers in almost all of them.⁵⁵ In 2005, the Productivity Commission's Health Workforce Report concluded that although precise quantification was difficult, there were evident shortages in workforce supply particularly in general practice and various medical specialty areas.⁵⁶ The Productivity Commission recommended the disbanding of AMWAC with a view to rationalising the institutional structures for numerical medical workforce planning.

- 7.76 The work of AMWAC has been taken over by the National Health Workforce Taskforce. That body was established in November 2007. No reports about medical workforce shortages have emerged since AMWAC was disbanded. Currently, the main source of data about workforce is the Medical Training Review Panel, a federal panel set up under the *Health Insurance Act 1973* (Cth), which reports on medical training opportunities throughout Australia. The Colleges also hold records on the demographic status of Fellows. One College informed the Inquiry that it has engaged a private consulting firm to identify the supply and demand parameters for its specialist services with the view to quantifying the gaps in the future provision of those services throughout Australia.⁵⁷
- 7.77 The number of position vacancies in New South Wales is one indication of the extent of staff shortages. However, position vacancies can never be an accurate guide given that vacancies reflect established positions determined by available funding, rather than actual need.
- 7.78 NSW Health's 'Area of Need' program is a clearer indication of serious medical workforce shortages. This program is designed to allow vacant medical positions to be filled temporarily by overseas trained doctors where there is sufficient evidence that positions cannot be filled by Australian registered doctors. The Area of Need program was initially created to address chronic shortages of doctors in rural areas. However, the most recent figures show that a significant proportion of Area of Need specialist medical positions are located in metropolitan and major regional centres. Over half the declared Area of Need positions are unfilled (285 out of 685 are filled).⁵⁸ Of 218 specialist positions, 92 are filled. 73 are in metropolitan locations and 145 are in rural areas. The Area of Need program suggests that the shortages are across the board, but greatest in psychiatry, anaesthetics, emergency medicine, geriatrics, obstetrics and radiology.⁵⁹
- 7.79 Shortages in the trainee specialist workforce is another indication of the overall doctor shortage. This is because trainee shortages will eventually translate into shortages in the specialist workforce. AMWAC made recommendations for an increase in first year trainee intake numbers each year in the areas of emergency medicine, gastroenterology, medical oncology, intensive care, haematological oncology, neurosurgery, obstetrics and gynaecology, orthopaedic surgery, pathology, psychiatry, cardiology, geriatric medicine, paediatrics, rehabilitation medicine and thoracic medicine. The most recent report of the Medical Training Review Panel shows that some of AMWAC's recommendations have not been met.⁶⁰
- 7.80 The Institute of Medical Education and Training submitted to the Inquiry that a Human Resources system needs to be introduced that captures current medical workforce according to specialty, location, stage of training, to enable workforce planning to be undertaken in a coordinated manner.⁶¹ I agree that this information is needed **as a priority**. Only then can it be ascertained, through the process of workforce planning, whether workforce supply and distribution match community need. I accept that identifying and recording the profile of the current medical workforce is a difficult task, particularly in view of the number of locums practising in the system. However, it is achievable. NSW Health informed the Inquiry that⁶² it has commenced implementing the replacement of a number of Corporate Information Systems and that some of the required workforce data, including employment status and location, will be available in late 2009.
- 7.81 In my view, NSW Health should progressively issue guidelines about the number of specialist staff needed in each area of service throughout the State. Part of that planning entails identifying, as far as practicable, where the shortages in the medical

workforce currently are, and where they are projected to be. The first step in this process is to develop a human resources database that records the current medical workforce according to specialty, location and stage of training. This task cannot proceed at a leisurely pace and NSW Health should be kept to its plan to implement the necessary systems by mid-2010.

Recommendation 15: *NSW Health design and implement a business information system that records current medical workforce according to specialty if any, qualifications, location and stage of training, to enable workforce planning to be undertaken in a coordinated manner. This system should be available within 18 months.*

Increase in medical graduates

- 7.82 Shortages in the number of specialists, and doctors generally, is the result of past Commonwealth government restrictions on the funding for the number of places in undergraduate medical schools. The number of domestic medical school graduates between 1994 and 2006 in New South Wales was as follows:

Table 7.1 Domestic Medical School Graduates 1996-2006

University	1996	1997	1998	1999	2000	2001	2002	2003	2004	2005	2006
Adelaide	97	96	93	103	98	90	84	81	94	85	92
Flinders	53	72	56	56	54	54	58	56	67	62	66
James Cook										58	74
Melbourne	189	161	168	184	190	193	174	206	179	178	211
Monash	153	131	131	132	125	129	150	145	144	143	123
Newcastle	75	56	62	65	60	65	65	59	65	59	61
UNSW	155	156	134	145	157	158	165	159	163	188	166
Queensland	209	219	211	224	191	220	220	215	225	218	215
Sydney	242	197	205	201	137	119	185	188	190	176	147
Tasmania	46	52	42	45	56	54	53	45	55	46	62
UWA	111	104	117	101	127	121	110	112	105	107	118
Total	1330	1244	1219	1256	1195	1203	1264	1266	1287	1320	1335

- 7.83 Many submissions to the Inquiry expressed the view that the past restrictions on university medical places are directly to blame for the current serious shortages in the number of senior medical staff (that is, Visiting Medical Officers and Staff Specialists).⁶³
- 7.84 I was told, and it was clear from my own observations during the course of the Inquiry, that the lack of graduate supply has been supplemented by the importing of large numbers of overseas trained doctors. I have addressed the particular challenges posed by overseas trained doctors below, but note that there are increasing questions about the ethics of first-world countries such as Australia reaping the benefits of doctors trained in developing countries.⁶⁴
- 7.85 The number of medical graduates is expected to double between 2007 and 2012. The predicted number of junior medical officers from 2008 to 2014 is depicted in this chart provided to the Inquiry by the Institute of Medical Education and Training.⁶⁵

Table 7.2 Workforce – Increasing numbers of medical graduates

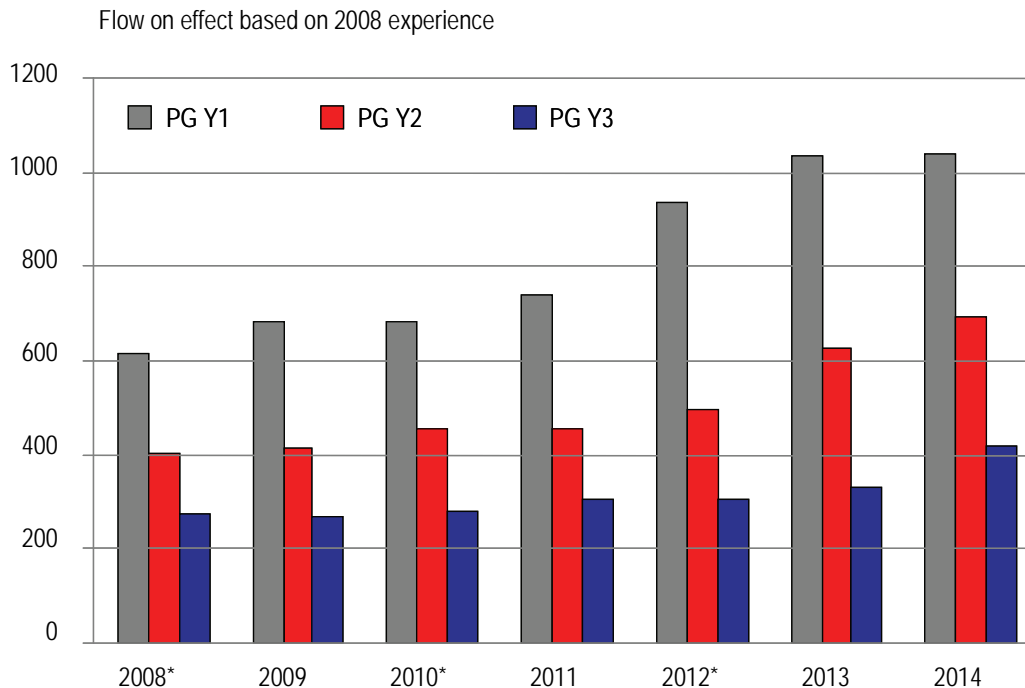

- 7.86 The impact of the increased numbers is expected to be felt in the public hospital system as early as 2009.⁶⁶
- 7.87 The evidence received by the Inquiry suggests that the increased number of medical graduates is perceived by health professionals as a positive and necessary development. It is recognised, however, that the problem is the lag time between increasing medical graduates and producing trained doctors. Those entering medical school this year will not be qualified specialists for 12 to 15 years and I was told that they will not reach the peak of their abilities for another decade after that.⁶⁷
- 7.88 Some clinicians doubt, however, whether this increase in graduate numbers will lead to a net increase in doctors, or simply eliminate locums and overseas doctors. There is also doubt as to whether an increase in the number of doctors will improve the distribution of doctors across metropolitan and rural areas. Some say that a net increase in the medical workforce will unfortunately have little effect on the numbers practising in the areas of real need, such as rural centres. In reality, it is said, when it comes to New South Wales, there will be an oversupply of doctors in the eastern suburbs and north shore of Sydney in the absence of proper planning and difficult decision-making about specialists' remuneration.⁶⁸
- 7.89 I agree that in the absence of planning, it seems unlikely that the increased number of doctors will have an impact on the key areas of shortage, to the extent to which they can currently be identified. Many clinicians made submissions similar in effect to the following statement about the absence of workforce planning in New South Wales:⁶⁹

"We don't actually have anyone sitting down and saying, "What do we actually need from the point of view of provision of service?", and that is whether it is medical, nursing or allied health or anything else for that matter.

We don't actually have numbers as to where we want people, what we want them to do, and I'm not aware that

anyone is actually doing any work in this State around that.”

- 7.90 The Australian Medical Association and the Australian Salaried Medical Officers Federation submitted that there is a need for careful planning to ensure that there are incentives in place for medical graduates to train in the specialties where there are shortages in the public hospitals.⁷⁰ I agree with this submission and the need for careful planning.
- 7.91 The Institute of Medical Education and Training told the Inquiry that it has received anecdotal evidence that some health services are employing fewer resident medical officers in order to accommodate the increased number of medical graduates that need to be employed as interns.⁷¹ If this is true, and the Inquiry did not take steps to confirm whether or not this anecdotal evidence reflects the true position, there will be a failure to increase the net medical workforce in hospitals and a skewing of the workforce to a more inexperienced group. This must have deleterious consequences for the safety and quality of patient care.
- 7.92 In the short term, the increase in the number of medical graduates presents both opportunities and challenges.
- (a) It presents an opportunity to address workforce shortages, including by placing interns into areas such as pathology, palliative care, rehabilitation medicine and mental health, areas in which there are currently not enough, or any, interns. Exposure to these areas in the early years of training is said to increase the prospect of a doctor pursuing this area of practice. It can also have other benefits. The Royal College of Pathologists of Australasia submitted, for example, that introducing rotations in pathology would broaden new graduates’ understanding of pathology and over the long term help to contain the number of pathology requests which are made, which are ever increasing.⁷²
- (b) It presents a challenge to provide training placements for all graduates and quality clinical supervision and training. I was told that there is little or no evidence of planning on the part of governments to ensure that positions with adequate training and supervision will be found for these new doctors.⁷³ In New South Wales there is no dedicated funding to train them.⁷⁴
- 7.93 It is proposed that the private sector may provide some of the training. In some areas this is already happening. The Inquiry received evidence, for example, that in general surgery at Port Macquarie, registrars obtain exposure one day a week in the private hospital.⁷⁵ The Council of Australian Governments have introduced a scheme under which registrars can undertake rotations through a range of settings including private sector hospitals, practices and community settings. Training positions established through this process are funded by the Commonwealth and approved by NSW Health, although doctors undertaking terms in private hospitals remain employees of the NSW Health Service.
- 7.94 Training in the private sector no doubt has limitations. I heard for example that there are difficulties in terms of patient expectations. Private hospital patients generally expect to have the surgeon of their choice, meaning junior doctors are limited in the amount of ‘hands-on’ work they can do. There is also a limit on the type of training available due to a lack of sub-specialty services in private hospitals.⁷⁶
- 7.95 On the other hand, the privatisation of outpatient clinics and the decreasing lengths of stay in public hospitals mean that medical students and junior doctors nowadays have limited access to the entire patient journey in the public hospital setting. The Inquiry was told that the private sector could provide many training opportunities which are

currently untapped. This has been recognised at the undergraduate medical training level where the changing nature of medical practice has meant that medical schools no longer rely on public teaching hospitals alone for clinical placements.⁷⁷

- 7.96 In my view, creating training placements in an expanded range of settings is one way to realise the opportunities to be seized with the increasing number of medical graduates. This needs to be undertaken in a coordinated manner and informed by robust workforce and service planning. I agree with submissions made to the Inquiry that improved human resources systems to capture accurate data in the existing medical workforce and their training programs and qualifications are required urgently to facilitate workforce planning.
- 7.97 With demand on the public hospital system increasing each year, NSW Health informed the Inquiry that it still expects to be short of medical graduates despite the expected increase over the forthcoming years. This means that we need to make the best use of the doctors we have.
- 7.98 This includes ensuring timely replacement of existing senior medical staff positions (VMOs and Staff Specialists). The Inquiry received evidence that there have been marked increases in delay in replacing existing medical positions since the amalgamation of area health services and the abolition of area health service boards.⁷⁸ I was told, with troubling frequency, that this is due to 'red tape' in the recruitment process as well as a resistance to recruit as a cost saving strategy. Delays of over a year are reportedly not rare, while existing senior medical staff are left to cope with an increased clinical load and teaching and training burden.
- 7.99 Delays in the recruitment process should not be the reason for which medical positions are vacant. It is a false economy for area health service or hospital managers to consider a delay in recruitment to equate to a cost saving.

Recommendation 16: *NSW Health ought review its policies and practices with respect to the recruitment of medical staff (other than junior medical officers) so as to require clear identification of the available senior medical officer positions by number and description which are unfilled and the date such positions became vacant, and which ensures that the recruitment of such medical officers occurs without any unnecessary or unintended delays. Each area health service should display, updated monthly, a complete list of all vacancies on the NSW Health intranet, together with the date when the position first became vacant.*

The role of colleges in supply

- 7.100 I have little doubt that the cut-back by the Commonwealth in the last decade of the last century in the number of medical graduates has been the greatest contributing factor to the present shortages of specialists, indeed of all types of doctors. Over and above this, in the course of this Inquiry I have heard conflicting explanations of the shortage of trainees in the public system.
- 7.101 One view, as reported by Dr Peter Brennan in 1998, but was repeated by others, notably NSW Health, in the course of this Inquiry, was that:⁷⁹

"In recent times people have questioned the role of the Colleges, and suggested that their unwritten objective is to protect the market position and financial security of their members and that they no longer reflect the aspirations of a new generation of doctors."

- 7.102 Another view, to the contrary, was that the failure is due to the inability by NSW Health to make trainee places available in the first place.⁸⁰ One submission illustrates the point.⁸¹

"The security of funding for specialist anaesthesia training positions in NSW public hospitals is a major area of concern for the Australian and New Zealand College of Anaesthetists. In particular for paediatric and rural training positions...

For many years the funding for these positions has been in doubt, with decisions being made at the last minute for one-off funding, 12 months at a time."

- 7.103 The Royal College of Pathologists of Australasia told the Inquiry, for example, that it has "repeatedly" attempted to bring to the attention of NSW Health over the last decade the inadequacy of the number of training positions for pathologists in NSW to continue to provide even the current level of services in the future. AMWAC determined in 2003 that at least 100 new pathology registrar training positions were needed to be established each year for at least the next 5 years. For NSW, this equated to 35 per year. It is now year 5. The College informed the Inquiry that there should be 175 positions funded in NSW but the NSW Government has funded 2 positions on a permanent basis over 5 years.⁸²

- 7.104 This Inquiry was told that the lack of available training positions in a specialty leads to a devaluation of the specialty, a lack of role models and a lack of training and supervision.⁸³

- 7.105 Another submission in relation to registrar training positions in a rural area stated:⁸⁴

"Every year we have to fight to get funding for the next year. ... The process is always unclear, the fight is always very time consuming and this will continue to recur because the govt [sic] has not allocated funds for rural rotations of training registrars."

- 7.106 I suspect that both these factors may play a part in some specialties and in some budget-driven strategies adopted by NSW Health. However, the challenge is for co-operation between the Colleges and the public hospital system. With that in mind, the two "sides" need to work together to best deploy the limited resources of the professionals and of the public purse. The recommendation of Dr Peter Brennan in 1998 still holds good a decade later. The 1998 Brennan report expressed the view that joint selection of trainees by hospitals and Colleges based on an attempt to meet the legitimate goals of both parties is the preferred option.

- 7.107 In order to facilitate such a cooperative effort, the Institute of Clinical Education and Training should enlist the help of the Colleges and in consultation with NSW Health work out protocols for the joint selection of trainees in all facilities, including public hospitals to which trainees employed by NSW Health are to be allocated.

Lack of generalists

- 7.108 I heard evidence, particularly outside metropolitan Sydney, that there is a lack of generalist doctors.⁸⁵ The ageing population, with complex and co-morbid disease states, requires and benefits from more generalised care, for example, from general physicians and geriatricians.

- 7.109 The lack of generalists in New South Wales is evident from the following table, which sets out some relevant specialties.⁸⁶

Table 7.3 Number of specialists

Speciality	Number	%
Anaesthesia	685	11.10%
Psychiatry	603	9.77%
Diagnostic Radiology	330	5.35%
Obstetrics and / or Gynaecology	313	5.07%
Paediatrics	280	4.54%
General surgery	259	4.20%
Orthopaedic surgery	236	3.82%
Ophthalmology	231	3.74%
Cardiology	201	3.26%
Anatomical pathology	181	2.93%
Gastroenterology	154	2.5%
Emergency Medicine	151	2.45%
Geriatrics	94	1.52%
Oncology	78	1.26%
Renal medicine / nephrology	77	1.25%
Public health	26	0.42%

7.110 It can be seen that the numbers of specialists do not necessarily match demand for treatments in their areas. For example, the small number of geriatricians (94 or 1.52%) seems pitifully inadequate given the emerging problems of an ageing population referred to above. The same can be said for renal physicians (77 or 1.25%), given the increase in the need for renal dialysis services across the state. The relatively small number of specialists in public health (26 or 0.42%) also seems low given that this area of medicine has such wide-ranging implications for reducing demand for hospital treatment.

7.111 The Inquiry received submissions that a trend towards subspecialisation has had consequences for the coordination of care. Because patients often have a team of sub-specialist carers looking after them, no single person may be aware of, or managing, all the different aspects of the patient's care. This is a problem given the growing number of older patients with multiple problems. It is not only a problem for older patients, however, as the lack of general physicians obviously affects all adults. I heard for example:⁸⁷

"One practical example of how this translates to patient care is illustrated by a case we're trying to transition from Sydney Children's Hospital to our adult colleagues. No one individual specialist would take responsibility for this 18-year-old adolescent with multiple organ difficulties, so we've had to approach a geriatrician as an alternative case manager. This is far from ideal psychosocially, and perhaps even clinically, but at least we are confident that someone will be monitoring the complex care from a range of subspecialists whom she will require as an inpatient and outpatient."

7.112 I was told that the relevant Colleges have not necessarily responded to the need for more generalists by training sufficient numbers of generalists. The Inquiry was informed, for example, that the Royal Australasian College of Physicians is not producing anything like the number of general physicians or geriatricians needed for patients.⁸⁸ It was said that 10 to 15 years ago the leading tertiary hospitals in Sydney

decided that general medicine was not necessary.⁸⁹ Training in general medicine was devalued as a consequence. I was informed that most adult tertiary hospitals in metropolitan Sydney have medical teams structured on an “organ-specific basis”.⁹⁰

- 7.113 I was told by several clinicians that the role of physician has been ‘deglamourised’ to the detriment of workforce numbers.⁹¹ The devaluation of general medicine has been reflected in the earning power of general physicians, relative to proceduralists. Financial incentives under the Commonwealth Medicare Benefits Schedule encouraged procedural subspecialisation. I note that changes were made in the 2007-2008 federal budget to provide an incentive for consultant physicians to practise in the non-procedural specialties, and to encourage new medical graduates to undertake training in these specialties.⁹² This consists of a higher Medicare fee for longer attendances by consultant physicians involving patients with multiple morbidities.
- 7.114 The Inquiry was informed that there is nevertheless little incentive for senior medical staff with appropriate qualifications to apply for positions as general physicians and geriatricians as the doctors filling those positions would be faced with an immediately heavy and almost unsustainable workload.⁹³ It ought be mentioned, however, that in relation to some hospitals, I was told that the subspecialists working in the hospital are also committed to general medicine and that this is working well.⁹⁴ An increasing number of doctors are reportedly choosing to specialise as geriatricians.⁹⁵
- 7.115 The Royal Australasian College of Physicians sees the lack of general physicians as a problem and considers it necessary to raise the profile of general physicians. To do this, it wants to raise the expectations of trainees so that they value the general physician positions.⁹⁶ This involves raising the profile of teaching in this area and providing an appropriate training program. In my view, this needs to happen.
- 7.116 The problem does not only affect the physicians. Subspecialisation in surgery is said to have eroded the number of general surgeons and the competence of subspecialist surgeons to manage the full range of general surgical cases.⁹⁷ The Royal Australasian College of Surgeons recognises 9 specialty disciplines by training and examination, including general surgery.⁹⁸ General surgery is the largest specialty group of surgeons⁹⁹ and yet attracts proportionally fewer applicants for training. In 2007, general surgery offered 51% of available surgical training posts but represented only 30% of applications.¹⁰⁰ The number of accredited training positions in general surgery in New South Wales has increased only from 99 in 2004 to 102 in 2008.¹⁰¹
- 7.117 The provision of general surgery services, including elective and emergency services, is especially threatened in rural and remote areas, notwithstanding that general surgery is the surgical specialty with the most and the highest proportion of practising rural Fellows of the College of Surgeons.¹⁰² The Inquiry was informed that subspecialisation is inimical to registrars undertaking rural rotations during their training as there is simply not enough volume to enable appropriate training in rural centres.¹⁰³
- 7.118 In many rural locations, the primary source of surgical care is from GPs with surgical skills. The Inquiry was informed that the Royal Australasian College of Surgeons has had a less than enthusiastic attitude to GP surgeons conducting surgery to fill the need for surgical skills.¹⁰⁴ The College has released a position paper in which it supports the need to resource GPs in performing selected surgical procedures in both metropolitan and rural settings, subject to the GP having a mentoring or supervisory relationship with a fully trained surgeon.¹⁰⁵ It has set out the curriculum that should be agreed for GPs undertaking a year of training in surgical skills. A Joint Consultative Committee¹⁰⁶ on Surgery, drawn from 3 Colleges, exists to promote surgical training for GPs required to have surgical skills in communities where a fully qualified surgeon is not available, or

where such skills can augment those that a qualified surgeon can bring to that community.

- 7.119 In my view, the lack of generalists is a problem and requires a fundamental review. This is partly an issue for the Commonwealth government to encourage doctors to work in the areas of workforce shortage. It is also a matter for NSW Health to determine where the areas of need presently are, based on evidence, and to fund positions accordingly. The Colleges then have an obligation to train and fill those positions based on their training and professional standards. Specialisation has unfortunately allowed the development of a 'siloed' approach to patient care, at the expense of a collegiate approach. It is incumbent upon the bodies to make a coordinated effort to identify and plan for service needs based on careful workforce planning.

Recommendation 17: *NSW Health ought consider the enhancement of its medical workforce by:*

- (a) *Reviewing the number and adequacy of prevocational and vocational places in rural regional and outer metropolitan areas so as to ensure a secure career path for medical officers who wish to work in these areas;*
- (b) *Identifying the extent of the current shortage of general physicians and taking steps to ensure that there are created appropriate number of training places so as to enable the current shortage of general physicians to be addressed;*
- (c) *Creating the role of a clinical support officer for doctors, designed to be able to assist in the undertaking of their roles and ensuring that their time is dedicated to clinical tasks rather than non-clinical workload.*

Working conditions

- 7.120 I was frequently told that the conditions under which doctors work in the NSW public hospital system are difficult and unattractive when compared with the private sector. A survey by the Australian Medical Association, Australian Medical and Salaried Officers Federation and NSW Nurses' Association found that over 50% of junior doctors had seriously considered leaving the public hospital system over the previous 12 months and about 62% of all doctors and nurses overall have had the same thoughts.¹⁰⁷ I was told that the prevailing attitude to working in the public hospital system not only reflects a generational change in attitude to work/life balance but also a perception about the attractiveness of working in public hospitals.¹⁰⁸
- 7.121 Numerous senior Staff Specialists gave evidence to the Inquiry about the relative appeal of working in the public hospital system today compared to previous years.¹⁰⁹ They said that working in the public hospital system in acute care medicine used to be seen as the pinnacle of medical practice. The lower salaries in the public system were offset by research opportunities, innovation and new technology as well as a stimulating academic environment.¹¹⁰ Medical advances were implemented through the public hospitals and doctors were attracted by prestige. I was told that this is no longer the case. One witness told the Inquiry that there is now sometimes a struggle to attract applicants of mediocre quality to even the most prestigious positions and organisations within the New South Wales public health system.¹¹¹

- 7.122 Underlying many of the concerns of doctors is that they are not encouraged to remain within the public sector. They experience increasing levels of bureaucracy, coupled with tighter budgetary constraints and little support for their training, education or research needs.¹¹² The Inquiry was told that the long term benefits of remaining in the public hospital system tend to be academic in nature, for example, the opportunities for research, teaching, sabbatical leave, participation in quality improvement initiatives and professional development. It is, however, these very elements that are 'squeezed' in times of workforce shortage and budgetary restriction. A frequent complaint from clinicians is that public health employers fail to see that they often eliminate the factors which are their only hope of attracting and retaining a specialist medical workforce.

Workload

- 7.123 Unlike for nurses, there is no state-wide tool to establish what is a reasonable clinical workload for junior doctors or registrars. There is wide variation in staffing levels in-hours, after-hours and on weekends and public holidays. One submission to the Inquiry expressed the view that there should be an agreed system relating to junior medical officer workloads for hospitals of different levels. If the clinical load of a junior medical officer or registrar were to exceed the agreed level, further staff recruitment should occur.¹¹³ I have noted these submissions.
- 7.124 Workload obviously has a lot to do with staffing levels. In a survey carried out by the Liverpool Hospital Medical Staff Council, no respondents believed that their department's staff growth had kept up with the level of activity within the previous 5 years.¹¹⁴ 30-53% of respondents reported a full complement of staff for less than 25% of the year. 62-88% of respondents had a full complement of staff for less than 75% of the year. All respondents thought that junior medical officers and registrars should be allocated to hospitals according to the hospitals' clinical throughput.
- 7.125 The Annual Medical Labour Force Survey conducted by NSW Health in 2005 showed that the proportion of the total workforce employed in public hospitals fell by about 4% in the period 2002 until 2005, with an increase in the proportion working in the private sector.¹¹⁵ A relative decline in the public hospital medical workforce coupled with increased patient throughput places additional pressure on the medical workforce that remains.
- 7.126 Submissions to the Inquiry said that the day-to-day busyness and excessive workload of senior doctors is an impediment to the delivery of high quality and safe patient care.¹¹⁶ This is said to be the result of an inadequate number of specialists. Excessive workload impedes effective case management because attention to detail, supervision of junior clinical staff, adequate note-taking and record-keeping and communication between health professionals is time-consuming.
- 7.127 I was told that the administrative burden on senior doctors exacerbates the workforce deficiencies.¹¹⁷ In addition to heavier clinical and training duties, consultants are required to manage a vast amount of paperwork and data that could readily be managed by an administrative assistant or data manager. I was told that these large workloads have led to senior doctors, including many of longstanding service, leaving their positions in the public health system.¹¹⁸ Career advancement for clinicians has in recent times led to a heavier administrative burden and moved them further away from direct clinical care. This means that their skills are not available to patients and they cannot be as effective as mentors, educators and role models to other health workers.
- 7.128 Greater effort needs to be made to retain the quality senior staff who are already working in the public hospital system. It is essential to provide senior doctors with

adequate administrative support, by way of data managers or administrative assistants, to free them up to carry out the tasks that they are trained to do. This would be of significant benefit to patients as well as to the senior doctors and the junior doctors whom they supervise. It is a false economy not to recruit administrative assistance as a cost saving measure. A reallocation of administrative tasks that inappropriately burden senior doctors would result in improved job satisfaction, retention of staff and improved outcomes for patients. These represent cost savings. My recommendation is set out above.

Lengthy hours of work

- 7.129 Doctors tend to work long hours, including demanding on-call rosters. A survey conducted by the Australian Medical Association and the Australian Salaried Medical Officers Federation in 2008 indicated that more than 40% of doctors in medical, surgical/operating and maternity/paediatrics departments are working “extreme hours”, defined to mean over 60 hours per week. 90% of doctors working in maternity/paediatrics work over 50 hours per week.
- 7.130 When it comes to long hours of work, junior doctors need special mention. I heard that it is widely accepted, and expected, in the public hospital system that junior doctors work extreme hours. Whereas the average total hours full time doctors work each week equates to around 53 hours, junior doctors work an average of about 57 hours a week, with 16% working more than 70 hours.¹¹⁹ The survey indicated that the extra hours worked consist of direct patient care and pointed to research showing the relationship between long working hours, fatigue and poor patient care. The Australian Medical Association has pointed to clinical studies that demonstrate that the performance impairment of an individual after 18 hours of sustained wakefulness is equivalent to having a blood alcohol concentration greater than 0.05%.
- 7.131 The Australian Medical Association has issued a *National Code of Practice - Hours of Work, Shiftwork and Rostering for Hospital Doctors (Safe Hours Code)* which sets out what it regards as the standards for safe working hours for hospital doctors in Australia.¹²⁰ The Code identifies three broad levels of risk - lower, significant and higher. Variables contributing to level of risk include total weekly work hours, whether the work was undertaken at night, if shifts exceed 14 hours, the extent of on call commitments, access to work breaks, and the long term work pattern. Many of the Colleges have recognised the Safe Hours Code in their accreditation guidelines. The Australian Medical Association’s Safe Hours Campaign, which commenced in 2000, has focussed specifically on the implementation of the National Code.
- 7.132 The Australian Medical Association conducts surveys of hospital doctors’ working hours. The survey conducted in May 2006 revealed that the hours and patterns of work for 62% of hospital doctors fall into significant risk and higher risk categories. A similar survey in 2001 which focussed only on junior doctors revealed similar results, although in the 2006 survey the longest hours worked by individuals has increased for the significant risk and higher risk categories.¹²¹
- 7.133 After that survey, the Australian Medical Association developed an online fatigue risk assessment tool for junior doctors who are worried about their working hours. The tool is intended to provide junior doctors who are asked to work unsafe hours with information that can help them negotiate improved rosters. It has reportedly recorded shifts of up to 36 hours.¹²² This Inquiry also received evidence of junior doctors working “extensive” hours.¹²³ One witness complained in confidential hearing about being rostered to work 3 days straight without a sleeping break.¹²⁴ This is unacceptable.

- 7.134 A risk assessment of the rosters of junior doctors conducted in 2001 came to this conclusion.¹²⁵

"A review of the specific rostering and work schedule characteristics of individual doctors in the higher risk category and a considerable number of doctors in the significant category, suggests these doctors are working at levels of fatigue and performance impairment which would put their health and patient safety at risk."

- 7.135 It further states that:

"the risk assessment data, viewed in the context of studies on fatigue and human performance, confirms the matter of excessive work hours by doctors goes beyond the profession and is a quality of care and patient safety issue."

- 7.136 It concluded that:

"More could be done by hospitals, medical education bodies and the profession to address the safe hours issue through revised work and rostering practices, job redesign, revised training practices and the improved utilisation of technology."

- 7.137 Workplace health and safety legislation exists in NSW to protect employees from unsafe work places and unhealthy work practices. NSW Health has issued a set of guidelines on preventing and managing work related fatigue which apply to all staff, not only doctors.¹²⁶ Those guidelines do not identify the rostering and work practice variables that contribute to fatigue and performance impairment associated with extended hours or set out any specific guidelines for the rostering of junior doctors. Rostering practices are determined by each individual hospital.

- 7.138 It was widely said to me that there is a new generation of doctors coming through the system who want a work / life balance, unlike previous generations. For example, I was told that there is difficulty finding the next generation of GP proceduralists as new GPs do not want to work long hours.¹²⁷ No doubt the different expectations of today's medical graduates will lead to reforms to current work practices. The evidence received by this Inquiry suggests that lengthy hours of work and fatigue continue to be accepted as a routine part of a junior doctor's working life.

Overtime

- 7.139 Although it is well known that junior doctors work extended hours, it appears that the true extent of hours worked often goes undocumented and unpaid. Indeed, it is the written policy of some hospitals not to pay overtime. Clinicians informed the Inquiry that they are under increasing pressure not to document the hours of unrostered overtime that they work and that they are frequently required to undertake work during 'their own time' for which they are not paid.¹²⁸ The evidence received by the Inquiry indicates that this is happening on a wide scale.

- 7.140 The problem was encapsulated in the following evidence from a registrar:¹²⁹

"Everyone gives at least an hour of their day without claiming overtime. Whilst we appreciate that that's the nature of the job, when you have people who are staying at work until seven or eight o'clock every single night, no-one wants to stay at work, people want to go home. There are jobs that can be handed over to the evening staff, but it's not feasible to hand all of your work over to a new registrar...I know that there should be

safe-working hours, but it seems like the way we're getting around safe-working hours is by saying, "You can work those hours, but don't claim it," so that it goes undocumented the number of hours people are working."¹³⁰

- 7.141 That registrar thinks that his employer is unrealistic about the hospital's service needs 'after-hours':

"The argument given to us by the administration is that there are overtime staff, there is a registrar and residents that are rostered on overtime, but if everyone walked out the door at five o'clock, it would just be physically impossible to have all those issues sorted out by one registrar and the few residents that are left on their overtime."

- 7.142 A group of junior doctors from John Hunter Hospital made a submission to similar effect.¹³¹ One reason reportedly given by the hospital for not paying unrostered overtime is that the doctors should go home. The doctors told the Inquiry, and I agree, that this shows poor insight and understanding of their position by the hospital. They are often required to stay back to accompany a ward round and complete necessary follow up work. They feel that they are not in a position to refuse to do this, as the ward round is a valuable bedside teaching opportunity and they must fulfil the requirements of their terms. I was also told that administrative staff have been known to alter timesheets by deleting overtime claims before approving pay claims.¹³²
- 7.143 One of the reasons registrars are often not free to leave at the rostered hour of departure is that they are often the principal point of contact with the patient's family or carers. Because families visit the patient at night and expect to be able to speak to the treating doctor, the registrar feels compelled to stay. This is entirely understandable. It is difficult to understand why a registrar who can substantiate working such overtime should not be paid for that work.
- 7.144 NSW Health policy¹³³ is that doctors can claim unrostered overtime without prior approval in specified circumstances (including medical emergency, patient transfer, extended theatre time, and a requirement for admission and/or discharge of a patient at the completion of a shift). All other unrostered overtime must be pre-approved. The Award does not limit overtime to these specified circumstances.¹³⁴
- 7.145 It appears that area health services' policies about unrostered overtime vary from time to time and from NSW Health policy. Under a policy of the Sydney West Area Health Service *Administration of Unrostered Overtime and Recall for Junior Medical Staff* (January 2008), the general principle is that pre-approval of unrostered overtime is not required, although all unrostered overtime claims must be adequately documented and substantiated upon request. That policy provides that in the 2008 clinical year, unrostered overtime will not be paid at all for terms which have received enhanced junior medical staffing, except in exceptional circumstances such as genuine patient emergency.
- 7.146 Whilst this last policy may seem unfair, the key to understanding it, seems to me to be in the enhancement of junior medical officers provided. If an additional junior medical officer has been added to the team for the express purpose of reducing the overtime being worked, then the area health service is entitled to expect, exceptional circumstances to one side, that there will be no overtime worked, and certainly not as a matter of routine. But there would need to be some agreement about whether the enhancement is truly to replace overtime or else to cope with an increased workload. In my opinion, necessary overtime which can be substantiated and is authorised ought be

paid. Issuing guidelines about this would be a start on the process of ensuring consistent application of overtime payments across the whole system.

Remuneration

- 7.147 Many doctors complained that they are not paid enough in NSW public hospitals to make this work attractive when compared with the private sector. Most Visiting Medical Officers consider that the time they spend in the public hospital system is “cost neutral” in that they are paid what it costs them to cover their operating expenses (e.g. rooms, secretary and indemnity cover) for the hours they work in the public system.¹³⁵
- 7.148 I heard that in some areas of practice, Visiting Medical Officers have to work in the private sector to allow them to work in the public hospital system. Paediatric anaesthetists at The Children’s Hospital at Westmead work part time for the hospital and undertake adult practice in the private sector because the hospital does not offer above award agreements.¹³⁶
- 7.149 Staff specialists are granted a right of private practice to supplement their hospital salary up to specified limits. Of course some Staff Specialists, such as emergency specialists, cannot benefit from this provision or benefit only to a limited extent. I was told that more than half of the total number of Staff Specialists in New South Wales earn little or no private practice income.¹³⁷
- 7.150 Some aspects of remuneration are outside the control of NSW Health. The Medicare safety net has driven up some private sector medical fees because the cost is passed on to the Commonwealth government, rather than the patient. This also impacts on the ability of the public sector to recruit and retain specialist doctors. An extreme consequence of this, which was suggested to the Inquiry, is that there will be no obstetricians employed by public hospitals within the next 12 to 18 months.¹³⁸ Indeed, it is said that only a tiny and disappearing number of obstetricians in New South Wales now work as Staff Specialists, namely those near to retirement, or with disabilities which limit private practice or from overseas who do not have provider numbers. I was told that off-site obstetricians with busy private practices earn 4 to 5 times the income of a Staff Specialist, after costs.¹³⁹
- 7.151 NSW Health informed the Inquiry that it is constrained by offering no more than 2.5% wage increases per annum under the NSW Public Sector Wages Policy 2007. Anything above 2.5% has to be offset against employee-related cost savings. The Policy applies to Public Service Departments, the Government Service, independent statutory bodies, any other public sector service within the meaning of the *Public Sector Employment and Management Act 2002* and State Owned Corporations. This does not include visiting practitioners (and therefore does not include Visiting Medical Officers). In 2007, the arrangements for sessional Visiting Medical Officers allowed for 2.5% increases in January each year until the end of 2010.¹⁴⁰ The remuneration of fee for service Visiting Medical Officers is set by reference to the Medicare Benefits Schedule and any adjustments that are made to that schedule.
- 7.152 Undoubtedly, relative rates of pay is one reason senior doctors migrate to the private sector. However, remuneration is not the only reason. As one witness told the Inquiry:

“There probably has to be an increase in salaries if you want to keep senior doctors in the public sector. There are a large number of senior doctors for whom the money is not the biggest complaint. The biggest complaint is the fact that, with the “areaisation”, they feel they have completely lost any control over decision-making and direction of their department.”¹⁴¹

- 7.153 I regard this perceived ‘loss of control’ of senior doctors over decision-making as an important issue affecting the delivery of acute care services in New South Wales and discuss it more fully in Chapter 31.
- 7.154 The Inquiry was also told that “little things” that do not relate directly to remuneration would make a big difference to recruitment and retention, such as providing a desk, computer and car parking for specialist medical staff.¹⁴² Bewilderingly, there is an increasing tendency to plan hospitals that do not include offices for specialist medical staff, for example, the Liverpool Hospital redevelopment. I accept that a relatively small investment may result in considerable recruitment and retention benefits when it comes to specialist staff, especially in outer metropolitan hospitals where recruitment is historically more difficult.
- 7.155 When it comes to remuneration, however, it is a simple fact that the public health system cannot compete on the same terms as the private health system. It appears to me, however, that if we could fix a number of other problems with working conditions such as staffing levels, education and training, and also improve the relationship between doctors and management, that would make NSW public hospitals more rewarding places to work.

Locums

- 7.156 Locums are appointed for specified periods of time to fill vacant positions. While traditionally locums are appointed to substitute for permanent staff during relatively short periods of leave, in recent times they have been used to fill chronic vacancies in the medical workforce. The Inquiry heard about individual doctors being engaged to act as locums for periods of up to 3 to 6 months at a time.
- 7.157 Locum appointments are not limited to doctors, but may also occur, for example, for nurses or pharmacists. The issues surrounding locums are, however, of particular concern with regard to the medical workforce.
- 7.158 The qualification of medical practitioners acting as locum can range from .that of resident to specialist. The Inquiry received a large amount of evidence that junior doctors are increasingly choosing to work under locum arrangements. Locums work across a number of hospitals and area health services.
- 7.159 There is no reliable data available about the scale and profile of the locum medical workforce in New South Wales public hospitals. Anecdotal information indicates that there are 2 types of locums:
- public hospital medical officers who are hospital non-specialists, in a specialist training program or are qualified specialists; and
 - professional locums.
- 7.160 Available data from NSW Health suggests that locums are mainly used by hospitals to meet workforce shortages. A survey conducted by NSW Health in 2007 showed that 79% of locums are engaged to fill a permanent vacancy. Other reasons locums are engaged are to fill positions left vacant because of annual leave, sick leave and study leave. Around 10% of locums are engaged for “other reasons”, which were not explained to the Inquiry.¹⁴³
- 7.161 The evidence received by the Inquiry indicates that there is a variety of reasons doctors become locums:

- To supplement existing remuneration earned in the practice of medicine (that is to work in a second job);
- To fill areas of workforce shortage;
- Need or desire for flexibility in work arrangements;
- Low morale and discontent with full-time employment in the public hospital system. For example, a junior medical officer gave evidence about her reason for leaving a training program and becoming a locum as follows:

"a lot of us have worked during periods of profound fatigue, and it comes at the expense of not only your ability to perform but also your own health, and I think it is something that needs attention.

A lot of my colleagues, including myself, have left the system potentially with that as a major factor. Yes, that is a huge area that needs very definite guidelines that are enforced. Often people are working 15 hours without a break, and often people are working through their breaks because there is no-one to cover them."¹⁴⁴

- 7.162 NSW Health informed the Inquiry that it has only recently commenced counting locums. NSW Health informed the Inquiry that use of agency staff is a symptom of overall workforce shortage. In the 2007/2008 financial year, agency locums averaged 305 FTE per month which is less than 4% of the total medical workforce. In addition, there are locums who are not engaged through agencies. NSW Health was not able to confirm what proportion of locums are engaged through locum agencies and what proportion are not.¹⁴⁵
- 7.163 The evidence received by the Inquiry shows that locums are widely used to fill rosters across New South Wales, particularly in outer metropolitan, regional and rural hospitals. So widespread is the use of locums that you would have to accept that they provide a significant proportion of acute care services in NSW public hospitals. Staff from some hospitals told the Inquiry that they rely on locums continuously and that they are a key component in maintaining and continuing basic services in those centres.¹⁴⁶ I have therefore taken the view that it is important to examine the issues surrounding the locum workforce in detail and to propose solutions to the problems in this area which have been drawn to this Inquiry's attention.
- 7.164 Before delving into the problems which I was frequently told about, I hasten to note that several submissions to the Inquiry highlighted the need for locums. Many submissions advocated a State-wide locum service covering all medical specialties, particularly to cover positions left vacant when doctors go on leave.¹⁴⁷ It was submitted that the availability of a comprehensive locum service helps to attract doctors to rural centres on a permanent basis. This is because it alleviates the perception that there is 'no escape' from a permanent move to a rural hospital due to the lack of cover during leave.¹⁴⁸ I accept that, for many reasons including the one I've just referred to, there is a need for a locum or casual medical workforce. I make these comments at the outset with the hope of alleviating any anxiety which the present discussion may provoke in the minds of some locums. There is, however, a need to make considerable reforms to the present system.

The problem with locums

- 7.165 There are several disadvantages to locums when compared with permanent staff.

Cost

- 7.166 Locums cost considerably more than a permanent employee, and a large part of this cost goes to the locum agency. The Inquiry received a lot of evidence about the cost to health services on using a locum workforce. Some examples of the kind of evidence received by the Inquiry surrounding this issue are that:
- A particular rural hospital pays \$120 to \$140 an hour for Emergency Department locum, \$2,000 a day for a locum for the obstetric unit, and \$2,500 for an anaesthetist, plus expenses;¹⁴⁹
 - Wyong Emergency Departments probably spent \$900,000 on locums last year, including more than \$3,000 per a week on locum agency fees;¹⁵⁰
 - Tamworth Hospital relies on locums to keep its Emergency Department operational. The cost of locums in the financial year to 25 March 2008 was about \$1 million;¹⁵¹
 - Locums in the Emergency Department at Orange Base Hospital and Bathurst Base Hospital who provide senior supervision are costing \$600,000 to \$650,000 per quarter;¹⁵²
 - Country areas are paying a premium for locums. Most weeks there is a bidding war for doctors for Emergency Departments which takes place between area health services and sometimes between hospitals within the same area health service. Locums in the city are paid between \$120 - \$150 per hour, but Broken Hill Hospital is forced to pay between \$150 - \$200 per hour due to its isolation;¹⁵³
 - One witness said that New South Wales is spending \$32 million on locums each year.¹⁵⁴ NSW Health confirmed to the Inquiry that estimated net cost of employing medical locums is approximately \$33 million per year.¹⁵⁵ The net cost refers to the additional payroll cost incurred through the use of agency staff but does not include costs external to payroll such as locum agency fees.
- 7.167 There are significant savings to be made by controlling locum costs that can be poured back into direct clinical care.
- 7.168 Locums are especially used to staff Emergency Departments. The task of finding locums was described as very time-consuming and frustrating. This is largely because of the 'price competition' that takes place, typically on Fridays, to engage locums, particularly for staffing Emergency Departments on weekends.¹⁵⁶ This involves a 'bidding war' between hospitals in an attempt to secure appropriate locum cover. It drives up the cost of using locums and occupies time that staff feel would be better spent on more productive pursuits.¹⁵⁷
- 7.169 The Inquiry was told that the locums and locum agencies are active participants in the 'bidding war'. Many locums delay signing up until the last minute when the pay rate is maximised.¹⁵⁸ Some locum agencies' commission or fee is based on the final negotiated rate. The Inquiry heard that some doctors who are employed full-time by one area health service take advantage of the generous rates by 'moonlighting' as a locum for another area health service.¹⁵⁹ I was also told that most of the agencies earn a fee approximating 15 per cent of the locum's fees. Some of them are running as high as 20%.¹⁶⁰
- 7.170 The higher pay rates for locums have 'knock-on' effects for recruitment and retention of permanent staff. The attractive rates of pay available to locums have provided an incentive for doctors to leave permanent employment and to reduce the number of hours they work. The Inquiry was told, and I agree, that paying doctors significant amounts of money to work as locums in areas of workforce shortage is an impediment to long term recruitment and retention of medical staff to those areas. It is my opinion

that the demand and supply issues in the medical workforce which gave rise to the locum 'industry' cannot be addressed while that industry thrives.

- 7.171 Conversely, it was said that there is currently "no incentive not to become a locum"¹⁶¹ because of some of the working conditions faced by doctors which I canvassed above. Nor is there an incentive for 'full time' locums to go back to the full-time workforce given their current levels of remuneration.¹⁶²
- 7.172 The abnormally high locum rates have meant that senior medical staff sometimes earn less than the locums they supervise.¹⁶³ This has engendered resentment in some areas and damaged relationships with local staff.
- 7.173 Some say that locum rates should be set by NSW Health.¹⁶⁴ It is said that they should be a slightly higher rate than career medical officer, registrar and resident medical officer rates and based on years of experience. I agree that there needs to be some order brought to the current unregulated system for engaging and paying locums which results on occasions in exorbitant sums being paid. My recommendations are set out below.

Experience

- 7.174 There is no way to test the competency of a locum before they arrive. The Inquiry was told that minimal background checks are carried out when locums are recruited.¹⁶⁵ Hospitals are required to take the assurance of a non-accredited locum agency at face value. The Inquiry was told that some agencies do not examine locums' qualifications and references at all and that very few agencies require feedback from the hospital about a locum's performance at the end of the appointment.¹⁶⁶ In some instances, the hospital discovers the limited range of skills the locum can provide when the locum arrives. This can, and has, led to the cancellation of surgery.¹⁶⁷ This is a matter of great concern.
- 7.175 Locums are often not familiar with the layout, equipment or procedures and protocols at the hospital to which they are posted.¹⁶⁸ This can cause delays in the treatment of patients, not to mention a risk to the quality of patient care. The Inquiry was told that hospitals could quite easily address some of these problems by providing a degree of orientation to new locums. This would include providing simple things such as appropriate passwords, swipe cards and keys.¹⁶⁹
- 7.176 As succinctly stated by Dr Smith at Broken Hill, we need to ensure that doctors who chose to work as locums have skills appropriate to the jobs which they choose to take up, that they maintain their skills, and that these skills can be validated.¹⁷⁰ Ensuring that this is so should not be problematic when it comes to specialist staff because they have obtained a fellowship from a College, but it is not so easy when dealing with locum doctors who are not specialists.

Training

- 7.177 There are presently no NSW Health requirements for locums to update their medical knowledge and skills through continuing education. Although qualified specialists or specialists in training often undertake locum appointments, meaning that they are, or have been, subject, to a training program in their area of specialty, there is no training program specifically for locums who do not pursue specialist qualifications.
- 7.178 A large part of the locum workforce is made up younger doctors who, I was frequently told, have opted to work as locums as a lifestyle choice. Many senior clinicians

expressed grave concerns about the ability of this group of junior 'roving doctors' to maintain competency and engagement with the wider public hospital system.

- 7.179 Each year doctors are required to submit to the New South Wales Medical Board, in their application for renewal of registration, details of any continuing medical education that they have undertaken in the previous year.¹⁷¹ The Medical Board accepts as evidence of continuing medical education evidence of satisfactory participation in College programs.¹⁷² Unfortunately this does not amount to a requirement to undertake continuing medical education, meaning that any doctor, locums included, can inform the Medical Board that they have obtained no professional education during the previous 12 months, without sanction.
- 7.180 In my view, there ought to be a requirement that medical practitioners beyond PGY1 & PGY2 obtain continuing medical education each year. The medical specialist Colleges would be the ideal bodies to administer that requirement so far as their fellows and members are concerned. Many Colleges already have maintenance of professional standards or continuing professional development programs which require fellows to undertake a range of educational activities.¹⁷³ In my view, the Institute of Medical Education & Training would be the appropriate body to administer the requirement as regards non-specialist hospital doctors.
- 7.181 This requirement needs to be enforceable under the *Medical Practice Act*. Unless there is an obligation to continue education, there will inevitably be a cohort of doctors moving around the system, as there is currently, whose skills are completely unknown and that are probably not current. The Inquiry is not the appropriate body to determine what the level of, or content of, continuing medical education is required each year.

Recommendation 18: *The NSW Minister for Health should consider, having regard to any advice from the NSW Medical Board, whether it would be appropriate to impose on all registered medical practitioners a mandatory obligation to undertake continuing professional education in each year of practice, and, if so, whether any amendments are necessary to the Medical Practice Act 1992 (NSW).*

No long term commitment

- 7.182 By definition, locums do not provide continuity of service, to either patients or the hospital. Some hospitals which rely heavily on locums are constantly changing doctors.¹⁷⁴ They come from around New South Wales and Australia as well as New Zealand. As Dr Battersby helpfully described:¹⁷⁵

"Part of the problem is even if a locum is medically good, they have no corporate knowledge, and that's where it makes it really difficult for us. I had a shift a couple of weeks ago, I think I was on with three locum CMOs, and two of the five residents were locums as well, and I was just tearing my hair out trying to supervise all of them who basically were there for the first or second time, to make sure that we had some sort of clinical governance and appropriate communication and disposition of patients.

Even though they were adequately skilled at assessing the patients and organising their management, it was just that corporate knowledge which makes a difference, and that's where your permanent staff can really help with that."

7.183 Another witness described the issue this way.¹⁷⁶

"It's somewhat being at the mercy of the predilections of people who don't have any investment in this facility, who I don't know absolutely what their performance may be, what their background is."

7.184 It is inevitable that short term appointees lack long-term commitment to seeing change through to its ultimate conclusion. As Dr Smith frankly stated in his evidence.¹⁷⁷

"Many of us who work as locums don't have any real commitment to systems improvement and involvement in the broader role of health service delivery. Most of the locums who come up here do a discrete piece work without any real commitment to the health service at large, and disappear."

Performance management

7.185 Locums work across a number of hospitals and area health services. Presently, information about the performance of locums and the hours that they work is not shared within the public hospital system. There is therefore no system for ensuring that locums have the clinical skills for the positions that they fill (principally, where they are not specialists) or for monitoring the risk to patient safety associated with the safe hours principle. This is no doubt because of the challenge that devising and implementing a system of that kind presents. It is time however that there was a robust system of performance review that applied to locums (as well as to all other doctors, an issue which I address below).

7.186 Against all of these problems, it is uncontroversial to say that permanent staff are preferable to locums from numerous perspectives.¹⁷⁸

Solutions

7.187 I am not the first person to identify these problems, nor investigate possible solutions.

Greater Metropolitan Clinical Taskforce's report

7.188 In 2004, the Greater Metropolitan Clinical Taskforce formed a working group (the GMCT Metropolitan Hospitals Locum Issues Group) to identify the issues associated with having a large locum workforce and ways of overcoming the problem. One of the cost related issues found by the working group was that locums earn up to 3 times the award rate, with locum agencies charging 10 to 15% commission per shift. In August 2005, the working group put forward a discussion paper setting out a strategy which, according to the paper, would conservatively save NSW Health \$35 million per annum. The Inquiry has not received information from NSW Health disputing that figure, nor data to enable this figure to be verified. I note, however, that it is a not insignificant component of the total employee related budget of the NSW public health system.

7.189 The recommendations of the working group can be summarised as follows:¹⁷⁹

- (a) Improve hospital-based prevocational and vocational training experiences for "junior doctors", including interns (postgraduate year [PGY] 1), residents (PGY2), senior residents (PGY3) and registrars (PGY3–8). Emphasis should be placed on maximising involvement of junior doctors in higher-order clinical work by increasing clinical, clerical and technological support, improving administrative arrangements associated with allocation, rostering and payment of junior doctors (especially arrangements for claiming unrostered overtime), and by fostering

development of clinical skills through active supervision, hospital-based training schemes and timely delivery of critical care courses;

- (b) Provide greater professional and educational support for non-specialist hospital doctors, including career medical officers and doctors in PGY3–8 who are not engaged in vocational training programs, including regular accreditation of positions, performance review, credentialling and maintenance of training and service records. Alternative, competency-based training pathways for non-specialist hospital doctors need to be developed;
- (c) Develop a centralised database of locum shifts, employment of locums, individual locum credentials and performance history which will reduce competition between hospitals for staff, and allow hospitals to find a suitable locum more effectively. It would also identify chronic vacancies requiring intervention;
- (d) Introduce a standard employment contract explicitly defining the roles and responsibilities of the locum doctor, locum agency and hospital;
- (e) Reduce the number of agencies through a tender process, allowing introduction of efficient credentialling, performance review, monitoring of locum working hours, and more equitable distribution of the locum workforce. In the longer term, establish a single, central locum agency;
- (f) Develop market-based fee schedules for locums and identify effective rewards to attract locums to unpopular hospitals and specialties, including non-financial incentives such as travel, accommodation and participation in training courses;
- (g) Ensure hospitals develop an orientation folder for locums, including computer passwords, instructions, protocols and contact details for a designated clinical supervisor;
- (h) Revitalise the commitment and engagement of the public hospital workforce. Implement key performance indicators that value social capital and wellbeing. Non-financial aspects of hospital work need attention — accommodation, meals, parking, work environment and child care, if inadequate, communicate to clinicians that they are not valued in their workplace. Develop a leadership program for promising junior clinicians including management and policy training and mentoring.
- (i) Organise an annual workshop encouraging continuing debate about morale in NSW public hospitals and how to improve it.

7.190 NSW Health convened an implementation group and circulated the GMCT’s discussion paper to area health services, medical organisations and other stakeholders. The implementation group met a number of times to identify actions for implementation.

7.191 Several submissions to the Inquiry described the measures taken by NSW Health to implement the GMCT’s recommendations as being “limited”, “cosmetic”, “around the edges”, “patchy” and “frustratingly slow”.¹⁸⁰

7.192 One of the participants in the working group told the Inquiry that he found the response of NSW Health bemusing. Usually, he said, when an employer is offered a concrete solution to a problem, they embrace it and work to implement it. He suggested that the Inquiry look at whether there was a systemic inability to absorb the proposed changes, particularly in view of the support given to the GMCT recommendations by the relevant industrial organisations.

7.193 The position of NSW Health is that progress was made, including the introduction of the Hospital Skills Program, a renegotiated award for Career Medical Officers, recent

centralisation of locum employment in some area health services and salary increases for doctors.

- 7.194 NSW Health informed the Inquiry that the GMCT report recommended centralising the management of locums to either the Institute of Medical Education & Training or the GMCT but that NSW Health's goal is to attract locums as permanent staff.¹⁸¹ Yet NSW Health informed the Inquiry that about 40 to 50 % of locum shifts are undertaken by doctors already employed by the public health system wishing to carry out extra shifts.
- 7.195 There appears to be a genuine incapacity of NSW Health either to reform the locum system along the lines recommended by the GMCT or, alternatively, to devise and implement its goal of turning locums into permanent staff. Steps like the Hospital Skills Program referred to above are valuable in themselves. However, placed against the wider problem of fixing the locum problem and ensuring the safety of patients, they point to change being implemented in small increments and so slowly that the problem will appear to "shrink" simply by being dwarfed by ever larger workforce shortages.

Accreditation of locum agencies

- 7.196 In August 2008, NSW Health established an accreditation system for locum agencies. Locum agencies will be assessed by a third party auditor body against Standards and Conditions set by NSW Health. After 17 August 2009, only businesses that have completed a third party assessment and submitted an acceptable compliance status to NSW Health will be allowed to supply locum medical officers to NSW Health Services. Under the Standards and Conditions, the responsibilities of locum agencies include:
- Conducting a recruitment interview with all prospective locums and carrying out "due diligence in line with the requirements of the relevant NSW Health policies as amended from time to time";
 - Undertaking pre-placement checks to ensure the locum is suitably registered, can validly work in Australia, has undergone a 100 point identity check and 3 referee checks that include current supervisors. Additional screening must be carried out in relation to preferred applicants including a health assessment, working with children check, criminal record clearance and screening and vaccination. Evidence of pre-placement checks must be supplied to the relevant area health service.
 - Having a formal performance management system in place that obtains feedback on the locum medical officer that can be provided to other NSW health services
 - Monitoring locum hours of work "as far as practicable" to ensure that safe working hours/principles are adhered to when placing locums in any NSW Health Service.
 - Supplying the locum with details of the position description, qualifications, skill levels, period of engagement, date and time and ensuring that the locum presents for the shift at the appointed time with photo ID and a letter of introduction from the agency;
- 7.197 If adhered to and enforced, these measures will undoubtedly improve the screening of locum doctors. Unfortunately these measures do little to address the excessive cost of using locums which was a key element in the GMCT recommendations. In my view, the best option would be for employment arrangements for locums to be centralised. The system of accrediting locum agencies is a good but second best option. Centralisation will provide greater transparency of the size and profile of the locum workforce and allow NSW Health to identify the areas in which locums are used to fill chronic vacancies. I discuss this further in the next section.

Centralise employment arrangements for locums

- 7.198 In my view, the employment arrangements of locums ought be centralised. Some hospitals and area health services have already formed pools of nurses and doctors whom they employ on a casual basis. This enables some record to be kept in respect of the performance of the clinicians, and for some performance management to occur.
- 7.199 Sydney South West Area Health Service and Sydney West Area Health Service have taken steps to introduce a casual medical pool consisting of a register of medical staff who are willing to undertake additional shifts within the area health service.¹⁸² I understand that this register commenced operation in October 2008 and that a small number of doctors are already filling shifts. I was also told that Hunter New England Area Health Service has implemented a centralised locum recruitment service which has reduced the cost of locums. I received evidence from a clinician in Tamworth who said that the service is only available to Newcastle and hopes that it will be expanded to include rural centres.¹⁸³ NSW Health informed the Inquiry that the service currently books locum doctors for Belmont, Maitland, Tomaree, Newcastle Mater, Glenn Innes, Kurri and makes occasional bookings for Tenterfield, Manning, Armidale, Narrabri, Warialda and Inverell.¹⁸⁴ I was told that Hunter New England Area Health Service intends to expand the service to all of its facilities and that implementation plans for this expansion are now in place.
- 7.200 A centralised database of vacancies and locum shifts should be developed. This would be preferable to having separate registers in each area health service. A single register obviates the administrative burden of area health services having to share information. Such sharing would be an essential feature to ensure prospective employers have access to all relevant information about candidates.
- 7.201 The database should include the credentials and performance history of locums. The database should be updated for each new locum and can be reviewed for returning locums. Guidelines need to be available to ensure that shifts are fairly evaluated.
- 7.202 Hospitals and area health services should be required to engage only those doctors who are registered on the database.
- 7.203 In my view, the register should also include the details of any currently employed specialist staff who are interested in providing additional shifts over and above their existing appointments. Including a pool of existing NSW Health specialist staff and paying such casual shifts at VMO rates would:
- Address the immediate shortage of senior medical staff (VMOs and Staff Specialists);
 - Give rise to potential cost savings where shifts are paid below locum rates and do not incur an agency fee; and
 - Improve quality control by reason of the fact that doctors filling the shifts are existing NSW Health staff whose credentials have already been screened in accordance with standard NSW Health recruitment policies. In addition, this system would reduce the reliance on overseas trained doctors to fill vacant positions. As discussed below, heavy reliance on overseas trained doctors to fill vacant posts raises a number of issues, including ethical and quality related issues.
- 7.204 The Inquiry is not the appropriate body to determine who would administer the database and oversee the accuracy and currency of the information.

Recommendation 19: *Within 12 months, NSW Health should create a casual medical workforce:*

- (a) *By instituting and maintaining a centralised register recording the details of all doctors, including their credentials and experience, who are available to fill casual shifts or to act as locums for specified periods;*
- (b) *By including on the centralised register the details of any currently employed or contracted specialists who are available to fill shifts on a casual basis;*
- (c) *Which is subject to appropriate performance reporting and performance management systems which are designed to ensure the continued competency of those on the list; and*
- (d) *Which has access to and is encouraged to undertake education and training so as to ensure the maintenance of and improvements in their skills and competence.*

Rates of pay / recruitment and retention of permanent staff

- 7.205 Establishing a centralised register of locum shifts and doctors practising as locums will obviate the heavy reliance on locum agencies. Employing locums under such arrangements should therefore prevent 'bidding wars' between hospitals resulting in exorbitant sums being paid to locum doctors.
- 7.206 A review of the system I have proposed should be carried out 6 months after its implementation. If bidding wars are still a feature of the system, in my view NSW Health should set a schedule of fees for casual and locum staff. Hospitals could authorise over-award payments to casual doctors in appropriate cases.
- 7.207 In my view, paying doctors significant amounts of money to fill chronic vacancies in a locum capacity is an impediment to long term recruitment and retention of medical staff to those positions. Consideration needs to be given to increasing the remuneration of permanent positions in areas of chronic shortage. Many of the vacancies are in rural and outer metropolitan areas. Locally-resident doctors are more beneficial to the system as a whole than locums and casual staff.¹⁸⁵ They provide continuity of care and are involved in training and quality initiatives. The locum problem would be largely solved were NSW Health to provide financial incentives to doctors working in rural and outer metropolitan areas on a permanent basis. NSW Health has said that it wishes to convert locums to permanent employees. The value it places on permanent staff needs to be reflected in its policies.
- 7.208 Other non-financial measures can help attract permanent staff. In my view, the Hospital Skills program is a critical initiative for providing supportive strategies for doctors not wishing to specialise and in retaining them as permanent employees of NSW Health. It is essential that the clinicians be involved in designing that program. In my view, progression in pay rates ought to be tied to progression through the training program.

Overseas qualified doctors

- 7.209 The NSW hospital system is presently heavily reliant on overseas qualified doctors, particularly in outer metropolitan, regional, rural and remote areas. They work in Emergency Departments, inpatient units in larger hospitals and in acute and continuing

care settings in most of the rural hospitals. During the hearing at Liverpool Hospital, for example, I was told that 23 out of the 32 registrars on the payroll in the Emergency Department are international medical graduates.¹⁸⁶ Some units, such as the Emergency Department at Campbelltown Hospital, are completely dependent upon recruitment from overseas.¹⁸⁷ Almost all the registrars in general practice training in Wagga are international medical graduates.¹⁸⁸ It seems that many rural hospitals completely rely entirely on overseas trained doctors for their medical staffing.

- 7.210 Overseas trained doctors have one of 2 avenues to obtain unconditional medical registration with the Medical Board. One way is to seek accreditation of their primary medical qualifications by the Australian Medical Council. This involves a 2 part exam followed by 12 months of supervised training at an Australian hospital.¹⁸⁹ During the period of supervised training, the medical officer is paid at a rate equivalent to that of an intern. While the doctor obtains unconditional registration at the end of that process, they are not accredited as a specialist.
- 7.211 The other avenue is for overseas trained specialists to seek recognition of their specialist qualifications. This involves assessment of the doctor's primary medical qualifications by the relevant specialist college.
- 7.212 Many hospitals rely on 'Area of Need' status to be able to recruit overseas trained specialists.¹⁹⁰ Where recruitment to a particular position has not been possible, NSW Health declares the position to be an Area of Need position. The employer selects an overseas trained doctor considered suitable for the position and the College and the Australian Medical Council then conduct an assessment in parallel to confirm the applicant's suitability for the position. They send a recommendation to the Medical Board for consideration of Area of Need registration. The doctor does not need to sit the Australian Medical Council exams and applications are assessed more rapidly than applications under the Council's usual pathway and specialist pathway.¹⁹¹
- 7.213 Some hospitals complained about the difficulties recruiting overseas doctors caused by the onerous requirements to be permitted to practise medicine in NSW. I think it is beyond my terms of reference to examine the system by which this is done, suffice to say that the stresses experienced by hospitals in recruiting overseas doctors highlights the importance of such doctors to the provision of medical services in NSW hospitals today.
- 7.214 I set out some of the matters that were brought to the Inquiry's attention:
- The lack of support, orientation and supervision of overseas trained doctors who are recruited to Area of Need positions has been an area of significant concern to practitioners.¹⁹²
 - There is little recognition of overseas training and the requirements of the Australian Colleges are onerous.¹⁹³ There is little transparency of the accreditation criteria used by Colleges to assess the qualifications of international medical graduates.
 - The recruitment process is long and it is arduous. It takes 6 to 12 months to recruit overseas trained staff.

"Not only do we have to go through the normal recruitment processes within the hospital, but we have to conduct advertising overseas, we have to engage visa applications, travel, et cetera, and all of this is to produce staff which are relatively short term. They might stay a year, they might stay two years, and then I have to go through the process again."¹⁹⁴

- Several witnesses raised concerns that recent changes to the Australian Medical Council exam have made recruitment of overseas trained doctors even harder. One concern relates to the locations where exams can be sat.¹⁹⁵ Another concern is that Area of Need applicants will now have to pass the Part 1 Australian Medical Council exam (which is a multiple choice question exam). This is said to have made it harder to recruit through the Area of Need process, which was one of the main methods of recruiting doctors, not only overseas trained doctors, to some hospitals.¹⁹⁶

7.215 Whilst we gain a lot of benefit from overseas trained doctors, it became apparent to me during the course of this Inquiry that we may not be doing enough to ensure a smooth transition for overseas doctors into NSW hospitals. More needs to be done to give them orientation and induction into the public hospital system in New South Wales and to train, supervise and support them while they are working. As Dr Branley highlighted:¹⁹⁷

"When you are meeting the after hours demand with graduates from overseas, you are expecting them to cope with quite a rapid transition to a new system and a new culture and they are often left relatively isolated doing night shifts and after hours shifts in particular."

This is a potentially dangerous issue and an investment needs to be made into training these people "that are really vital to keeping our system running".

- 7.216 I heard that international medical graduates can experience difficulties with language, in interpreting what they hear, responding in ways which patients can understand, and in writing notes.¹⁹⁸ They can also experience difficulties with the local culture.¹⁹⁹
- 7.217 Unfortunately, some of them are placed in positions above their level of experience or training and do not receive adequate supervision or training "to get them up to the level they need to be".²⁰⁰

What training is provided?

- 7.218 Some overseas doctors come from quite different health systems and societies. There are significant differences in how medical care is delivered in NSW.
- 7.219 The Inquiry received evidence from several overseas trained doctors.
- 7.220 Dr Sultan, a doctor who trained in Iraq, gave evidence that he would have benefited from pre-employment training before taking up a position at a rural hospital in New South Wales. He and other overseas trained doctors are firmly of the view that NSW Health should provide an orientation course for all overseas doctors, including specialists, who come to Australia to help them adjust to working in New South Wales hospitals.²⁰¹ Those doctors said that they were left to learn the system for themselves 'on the job' and provided with no formal guidance.
- 7.221 Dr Sultan is of the view that doctors coming from different social and health systems have a special need for training in the following areas, by reason of their novelty in the Australian context of health care delivery:
- the patient-centred and multi-disciplinary approach to care;
 - communication skills;
 - the structural hierarchy of the public health system in New South Wales;
 - who to talk to in the event of a problem or question.²⁰²

- 7.222 Presently, the only funded course for international medical graduates who come to work in New South Wales is a 3 week course for those who have passed the Australian Medical Council exams and have been offered and accepted a position for a supervised year of training. It is therefore not available to all international medical graduates who work in New South Wales.
- 7.223 The AMC Graduate Pre-employment Program runs over three weeks. The program consists of a one-week lecture series, a one-week clinical skills workshop and a one-week hospital attachment in the hospital network within which the AMC Graduate is scheduled to undertake the prevocational training period.
- 7.224 The lecture series covers such topics as medical administration, federal and NSW health systems, the hospital hierarchy, patients rights, responsibilities and medical ethics, clinical documentation, management of the deteriorating patient and case communication techniques, the multidisciplinary team, communication workshop, working in emergency departments and 'breaking bad news'. The program is free of charge.
- 7.225 A lot of international medical graduates have special education and training needs. The Institute of Medical Education and Training submitted that NSW Health should provide them with dedicated clinician trainers, mentors and pre-internship terms. It also suggested that there be funded research to see how systems can be improved so that overseas trained doctors are better integrated into the public hospital system.
- 7.226 In my view, an important first step is to provide an orientation program to overseas trained doctors. That program should cover the topics covered in the lecture series provided in the context of the AMC Graduate Pre-employment Program.

Recommendation 20: *NSW Health should review the current induction program which is undertaken for overseas trained doctors prior to them commencing employment in the NSW public hospital system, and enhance it so as to make more efficient and effective the employment of overseas trained doctors.*

A bit of understanding

- 7.227 I was reminded by Dr Atkin Pitsoe, an overseas trained doctor working at Wagga, that some understanding needs to be engendered in hospital management and clinicians of the rigorous vetting procedure that overseas trained doctors have endured to be entitled to work in NSW, together with the performance management conducted in their first and second years here.²⁰³ He advocated a system in which hospitals work with overseas trained doctors in a manner which encourages growth and commitment so that the doctors know that they are supported.
- 7.228 I met some overseas doctors who felt particularly vulnerable if a complaint was made against them by their colleagues or a patient. In some cases, the complaints procedure was culturally unfamiliar to the overseas doctor, and they did not cope well with the stresses which it imposed. In other cases, overseas doctors felt singled out for criticism or as though an air of suspicion hung over them by reason of their foreign training. One witness spoke about a general attitude of "paranoid hysteria" and a "damage-control mentality" around the service overseas doctors provide.²⁰⁴

"The successes we achieve are downplayed because of who we are and the little oversights we make are blown up into disasters."

- 7.229 I think that it would be sensible for hospitals to provide overseas doctors whose professional practice or conduct is the subject of complaint with a representative who would guide them through any complaints process. The doctors need to feel free to expose their weaknesses for constructive improvement.

Performance management

- 7.230 Unlike most industries, there does not appear to me to be any adequate state-wide system of performance management for doctors, even for Visiting Medical Officers.
- 7.231 NSW Health informed the Inquiry that all NSW Health employees are required to undergo performance appraisal by reason of Policy Directive *Performance Managing for A Better Practice Approach for NSW Health*.²⁰⁵ This policy does not apply specifically to medical staff and identifies broad principles to be followed by area health services when designing a performance management process. It does not set down any requirements about the frequency or method of performance appraisal and I was told that its application is inconsistent.²⁰⁶

Contractual arrangements with medical staff

Doctors in PGY1 and PGY2 (interns and residents)

- 7.232 All interns and Australian Medical Council graduates in New South Wales public hospitals progress to year 2 subject to satisfactory performance and obtaining unconditional registration.²⁰⁷
- 7.233 Each hospital has a director of prevocational education and training. One of the tasks of the director of prevocational education and training is to ensure an adequate evaluation system of junior medical officers' performance.²⁰⁸ That person is a clinician who takes on the role in addition to his or her clinical load. I was told that at a large hospital, the director of prevocational education and training may be responsible for 140 junior doctors consisting of 70 PGY1s and 70 PGY2s. At a smaller hospital, it may be 25 or 30 junior doctors.²⁰⁹ The junior medical officers are spread across different hospitals at different times, meaning that the director is reliant on feedback and comments from local supervisors.
- 7.234 Assessments of junior medical officers in their first two postgraduate years occur in the middle of each of the 5 terms and at the end of each term.²¹⁰ Supervisors complete a progress review form in which they indicate whether or not the doctor performed to a satisfactory standard during the term.²¹¹ I was told that the system is reasonably reliable at revealing whether a particular junior doctor has a performance issue but that it is not effective in revealing the nature of any problems.²¹² This, I was told, is mainly due to the way in which supervisors generally fill in the form.
- 7.235 IMET informed the Inquiry that it is currently reviewing the form to review trainee progress.²¹³ It is anticipated that the new form will include a section to be completed by the trainee after the assessment, giving feedback on the term experience. The data will be collated centrally by IMET and fed back to the training networks while protecting the identity of the prevocational trainee. This would also provide de-identified information on term, hospital and network performance to be used for accreditation and transparent education performance assessment purposes.

- 7.236 I was told that historically approximately 5% of interns are not approved for unconditional registration at the end of the internship year.²¹⁴ It is a matter for the hospital to determine what process ought be followed with respect to those not approved for unconditional registration. The intern may be required to complete another term or set of terms until satisfactory reports are obtained.
- 7.237 There is no all round performance assessment or formal appraisal by way of direct clinical observation of the junior medical officer.²¹⁵

Doctors in specialist training

- 7.238 Doctors in specialist training programs are engaged by area health services under a contract for the minimum potential period for completion of the training program.²¹⁶ The contract length varies depending on the training program, including whether the training program is divided into basic and advanced training components. In most circumstances the length of the contract is not less than 2 years. Continuation of the contract is dependent on progression through the program at the expected rate and is subject to satisfactory annual performance review.²¹⁷
- 7.239 Performance assessment is required and administered by the various Colleges. This is a requirement of Australian Medical Council accreditation guidelines.²¹⁸ The frequency and model of performance assessment vary between the Colleges. They include 360 degree assessment whereby a range of colleagues and peers (not limited to medical peers) provide a report on the professional skills of the trainee once per year during each year of training or at the end or during the course of each term. Colleges require trainees to have supervisors as part of their accreditation criteria.
- 7.240 Hospitals have site directors of training not only for prevocational doctors but also for doctors who are part of training networks, including basic physician training and psychiatry. Their responsibility is to make sure that training, assessments and mentoring occurs appropriately.

Non-specialist hospital doctors

- 7.241 Doctors who are not part of a training program are engaged for a specific period as either resident medical officer, registrar or senior Registrar, dependent on the nature of the position.²¹⁹ Progression through the pay scale is based on years of service as a resident medical officer, registrar or senior registrar subject to satisfactory performance.
- 7.242 There is no training requirement or formal performance assessment system for non-accredited registrars or non-specialist medical officers.²²⁰ IMET has sought to address the training deficit through the Hospital Skills Program.

Visiting medical officers

- 7.243 NSW Health issued a State-wide policy for performance assessment of visiting practitioners in 2005.
- 7.244 Performance review is required to take place once a year and on or around the time of the anniversary of the VMO's service contract period wherever possible.²²¹ The supervisor of the VMO carrying out the review is the medical person administratively responsible for the practitioner. In larger facilities, this may be the Head of Department. In smaller facilities, this may be the Area Director of Clinical Operations.

- 7.245 Issues discussed range from matters concerning ongoing professional development and clinical practice through to issues concerning the performance of the VMO. NSW Health policy sets out a model record of review and plan of future activities.
- 7.246 The theory set out looks appropriate and acceptable. However, I was left on the evidence with the distinct impression that this performance management process really achieves very little and is regarded as formulaic rather than a process of “adding value” either for NSW Health or for the VMO. The problem is in the implementation, not in the policy. The process of implementation and reporting needs to be reviewed by each area health service so as to ensure that the process is a worthwhile one.

Staff Specialists

- 7.247 Staff specialists are usually appointed at the year 1 level and progress to the next incremental step on the anniversary date of their appointment. However, having regard to the skills, experience and performance of a Staff Specialist, an initial appointment can be made at a higher level or there can be accelerated progression through the steps.²²²
- 7.248 Under the Award, each Staff Specialist is required to have a written annual Performance Agreement developed jointly with his or her designated supervisor.²²³ The Staff Specialist and his/her designated supervisor are required to jointly review the practitioner’s performance under the Performance Agreement twice in each 12 month period.
- 7.249 A Performance Agreement includes a range of matters including a job description, expectations in respect of management responsibilities, quality and teaching activities, continuing education and research and health outcomes.²²⁴ It can also include private billing expectations for level 1 Staff Specialists, specific commitments and standards from the employer for the provision of clinical support and any financial, activity targets or health targets.
- 7.250 Each assessment is required to include an evaluation of the Staff Specialist's level of achievement of specified service improvement objectives which are agreed between the Staff Specialist and his/her supervisor.²²⁵
- 7.251 The impression I gained throughout the Inquiry is that performance assessment of Visiting Medical Officers takes place annually, but that performance reviews for Staff Specialists do not always take place.

Recommended improvements to the performance appraisal system

- 7.252 Performance management is a way of involving doctors in the management of a hospital. It is also a way of defining the doctor’s role. It provides an opportunity to receive feedback about how well a doctor is meeting expectations and to support them to develop their skills and knowledge, become more effective in their current role and enhance their career development.
- 7.253 In my view, there needs to be a state-wide performance management system introduced for all doctors working in NSW public hospitals which is simple and relevant. My impression is that the performance appraisal mechanisms in use for junior medical officers (apart from registrars whose Colleges require and perform reviews), Career Medical Officers and Staff Specialists is fairly haphazard. I was told by one Staff Specialist that after 20 years of being a Staff Specialist he had had his first performance appraisal in 2008 and that it was a meaningless exercise.²²⁶

- 7.254 The traditional expectation in medicine, of course, is that doctors will keep up to date and do something about their poorly performing colleagues.²²⁷ This can lead to a culture of hiding errors and behavioural problems. The only check on this self-regulation has been the disciplinary process, which is generally only triggered in extreme circumstances.
- 7.255 In my view, performance appraisal needs to be undertaken by a clinical leader with management support. The Inquiry was told that as a general rule, clinicians find it very difficult to address poor performance by their colleagues. I was told that it is difficult for a head of department to do performance appraisals of his colleagues with whom he or she might share an office, unassisted by anyone from management.²²⁸ Clinical leaders are rarely accountable for the performance of the system or the behaviour of their colleagues. A system of appraisal of all doctors by a clinical leader, with management presence and support, is an opportunity to provide supervised doctors with senior medical input and direction, which I was told is desperately needed.
- 7.256 For PGY1 and PGY2, supervisor reports should continue to be a key element of assessment, but in my view need to be supported by structured feedback sessions during the term, not just at the end. In my view, the focus should be on clinical skills development and fostering of medical professionalism. I am also in favour of 360 degree performance reviews. Incorporating regular evaluations of senior staff by junior medical officers is likely to be effective in identifying those who are unsuitable for supervising junior colleagues. Given what I have said about supervision in Chapter 13, this is an important benefit of a 360 degree performance assessment process.

Recommendation 21: *NSW Health should implement within 12 months a program which ensures that an annual performance review for each employed or contracted doctor, other than a doctor in training, is undertaken jointly by a senior clinician and a management representative.*

In order to enable an annual performance review program to occur, NSW Health should ensure there exists for each position to be reviewed a job description identifying:

- (a) roles and responsibilities for each designation and position held by a doctor;*
- (b) performance criteria for inclusion in contracts with respect to each position held by a doctor.*

Clinical leaders

- 7.257 Which brings me to perhaps the most important subject in this chapter.
- 7.258 Clinical leadership occurs at all levels of patient care and refers to:
- “the process of leading a set of activities that improve the delivery of safe clinical care, and the set of attributes required to lead a team, unit, stream or cluster”²²⁹
- 7.259 The Inquiry received a large amount of evidence to the effect that clinical leadership is desperately needed.²³⁰ Clinical leaders are needed to motivate and inspire their peers and help set the standards for healthcare delivery. As one submission stated:²³¹

"The Health System is populated by an enormously devoted collection of staff who, at every level, are trying to do what *they think is right* for patients. Unfortunately, without adequate leadership and direction, they are often left to decide what *they think is right*, and how to go about achieving it."

"In as complex a field as health, there are so many opportunities for things to go wrong, that without a very highly organised, strongly-directed system we are almost guarantee to fail. And we do. In particular, the same mistakes are frequently repeated; which is the hallmark of a system that is not learning and not making the appropriate adjustments."

- 7.260 The role of clinical leaders is absolutely vital and encompasses the following:
- (a) Performance management of doctors, as already discussed.
 - (b) Providing a link between clinicians and management. The Inquiry received a large amount of evidence about the divide between clinicians and management. I deal with this issue more fully in Chapter 31. Clinical leaders are needed to work with management to lead and motivate staff and help design systems for safe, effective and efficient patient care.
 - (c) Driving reform. I have seen, during the course of the Inquiry, that senior clinician involvement from the outset in devising clinical reform is critical to its success. Clinical leaders are needed to drive this reform through persuasion, negotiation and clinician engagement. Non-clinicians have very little chance of successfully effecting change in clinical practice. Effective clinical leadership is essential and is the antidote to a system in which professionals operate independently. This involves building consensus around evidence-based models of care and requires 'clinical champions'.
- 7.261 The Clinical Excellence Commission says that an effective clinical leader must be able to:
- demonstrate a high level of technical mastery;
 - build the capability of the clinical team;
 - advocate for patient safety and integrate system improvement into clinical care;
 - have insights into their own leadership style and its impact on others;
 - work effectively with a range of clinicians and managers;
 - use consensus development and vision to set, align and achieve goals and resolve conflict and balance demands within the larger environment.
- 7.262 It ought be emphasised that a clinical leader is not necessarily the same as a clinical manager. A clinical leader is a leader because of his or her clinical skills and experience. I discuss clinician managers in Chapter 31.
- 7.263 The need for clinical leadership does not only relate to the need for leaders to innovate and implement reforms. Many of the submissions to the Inquiry which highlighted the need for clinical leadership directed the Inquiry's attention to the questions: who is the team leader? who is accountable for ensuring patients receive high quality effective and efficient healthcare?²³² I was told that, increasingly, medical teams in public hospitals are becoming amorphous without proper structure or leadership.²³³ Part of the reason is that medical teams are increasingly losing consultant presence and therefore leadership.²³⁴ Leadership is especially needed in a multidisciplinary environment.

- 7.264 Without clinical leadership and direction, I was told that junior doctors can learn maladaptive habits from registrars who are, after all, only trainees themselves and that registrars pick up various habits from their consultants.²³⁵ I received submissions that the team registrar is a critical communication reference point, but consultant leadership remains vital. It is clear to me that engaging senior doctors is a prerequisite to securing clinical leaders. This requires (a) the relationship between doctors and managers to be radically improved and (b) a clearer articulation of responsibilities within the Health system so that the need for vision and leadership from senior medical staff is clearly defined, communicated and understood.

Support and encouragement

- 7.265 It seems to me that there is little, or no, fostering of doctors' leadership skills. I was told that any leadership tendency that a doctor may have is frequently quashed by frustration, rather than nurtured and encouraged.²³⁶
- 7.266 The selection, training and ongoing support of clinical leaders is somewhat haphazard and undeveloped in NSW. I heard from many senior clinicians that when they do take leadership positions, it is only because no one else is available to do so.²³⁷ Doctors told me that they were given a leadership role without any training in leadership or management.²³⁸ That is not to say that doctors are not capable of taking on such roles, but they are not given any guidance or resources to assist them. Nor is there any career path for clinical leaders.
- 7.267 As a consequence, there is major variability among clinical leaders and little encouragement of younger clinicians to show and develop leadership qualities. On the other hand, during the Inquiry I had occasion to witness and consult with several senior clinicians working within the New South Wales public health system who have all the attributes of an effective clinical leader identified above. Not only that, but they selflessly give of their time and effort to improving the system for patients.
- 7.268 Whilst the tasks taken on by clinical leaders are time consuming, they are not provided with administrative support or dedicated time to enable them to do this. One clinician who is involved in a range of projects across 5 different networks spoke about the time spent in networking:

"The time spent on designing, negotiating, implementing and evaluating such projects is similar for each project and, in total, a very substantial case load in addition to my clinical and other ... managerial roles. At times it would be much easier for me to walk away from such networking projects and concentrate on individual patients as a general paediatrician. At times, I have certainly felt networked out. However, I see this collaborative and non-competitive environment that is core business ... as a mandatory component of any comprehensive health system."

Remuneration

- 7.269 Some senior clinicians told me that the only way to achieve clinical leadership is to take an academic appointment whereby a background salary is provided.²³⁹ There is no financial incentive for other doctors to undertake a clinical leadership role. By way of example, I was told that a surgeon with private rooms who works in the public hospital system is not remunerated for that work because the income for the period of time worked in the public hospital does not cover his or her operating costs (rooms and

secretarial cost). As such, carrying out extra and unremunerated responsibilities associated with clinical leadership is not feasible.

- 7.270 On the other hand, some say that additional income would not make any difference as the key motivator is a belief in the system.²⁴⁰

"I don't think additional salary would make any difference really. It is about their belief. Maybe it is a title. It is not a pay scale. I think it is something intangible that makes them want to do it, part of a package."

- 7.271 In my view, the public health system needs to be realistic about supporting and remunerating clinicians who are engaged in clinical leadership activities that take them away from clinical activity.

Managing a Budget

- 7.272 An important question that arose very early in the Inquiry is the extent to which clinicians ought to have control of budgets at the hospital level. The Inquiry received a lot of evidence from senior clinicians that they are frequently told by managers that there are no funds. Alternatively, when doctors occupy positions which require managerial responsibility and leadership, they are not told what their budget is (until it is exceeded) or given any authority to manage the funds. It seems that the discussion frequently turns around the question of responsibility for budget rather than responsibility for clinical care.

- 7.273 Currently, there is no training to teach clinical leaders how to manage a budget in a thoughtful way. As one clinician said to me, if clinicians want to be involved in real authority, they will have to learn how to manage money in a public system. However, they have to be trained in how to do this. As a senior clinician said:²⁴¹

"As a department head, I have had no training in clinical budgeting; I had no support at a clinical level to actually manage that budget. Our business managers were hoovered out of the system with the State revamping the area health services. There is virtually no support at a clinical level for how you actually manage a budget, and there is no ability to be intuitive, if you like, and inventive around how you might actually manage \$5. There is any number of ways to spend \$5, but there is no ability within the system to actually have that inventiveness, to have that creativeness; all you really have is the accountability when you cost too much to run your service."

- 7.274 The training needs for doctors and nurses with regard to leadership and management is an important issue in New South Wales.

- 7.275 It is relevant to highlight an important point which was made to me by a senior clinician. That is that effective clinical leaders are those who are intimately and constantly involved in developing and advocating improved systems of clinical care. That is to say, that it is not necessary that they be "financial wizards". What is important is that managers are open to having a dialogue with clinical leaders and supporting them in the process of implementing innovation and agreed models of care.

"Failure to do that causes great distress among clinicians who spend a lot of time developing these notions and these ideas. When it is successful, it has a wonderful energising effect because they really do believe that they are making a big contribution to

effective health care and someone else has picked up the budget. ... doctors are really good at innovative health care issues and they need the support to do that. They shouldn't have to worry about the bottom line to the extent of being an informed financial manager. They should have the support for that to happen."²⁴²

Training

- 7.276 The Clinical Excellence Commission runs a Clinical Leadership Program for medical, allied health, nursing and ambulance officers who lead a clinically-based team. The program aims to build a critical mass of effective clinical leaders who are agents for sustainable system improvement and patient safety. One component of the program delivers training to middle managers and is delivered in area health services by facilitators employed via the program. Another component delivers training to senior clinicians and is delivered in Sydney. The Inquiry was informed that the program costs about \$2.5million per annum to fund both the modular and state-wide modes which is a significant proportion of the Clinical Excellence Commission's budget.²⁴³
- 7.277 Clinical leadership training programs are to be applauded and in my view should be expanded. Clinical leadership has to be coupled with a partnership between management and clinicians. I make recommendations in Chapter 10 about leadership training for clinicians, as one of the functions of the NSW Institute of Clinical Education and Training.
- 7.278 I also make recommendations in Chapter 31 about the introduction of a defined career path and structure for senior clinical leadership, and for senior clinician participation in senior administration and management roles.

-
- ¹ NSW Medical Board, Annual report 2007.
 - ² NSW Health briefing, 4 April 2008, transcript 40, based on data from NSW Medical Board.
 - ³ NSW Health, Profile of the Medical Practitioner Workforce in NSW, 2006.
 - ⁴ Letter from NSW Health to Special Commission of Inquiry, 31 October 2008; NSW Health *Annual report* June 2006/2007.
 - ⁵ This includes staff specialists (2275), clinical academics (163), medical superintendents (18.8), medical officers (6.4): Letter from Deborah Hyland, NSW Health to special Commission of Inquiry, 31 October 2008; NSW Health briefing, 4 April 2008, presentation p13.
 - ⁶ This figure needs to be treated with caution as the total number of doctors practising as locums cannot be ascertained.
 - ⁷ Locum doctors recorded on NSW payroll for June 2008. Figures include casuals and exclude overtime: Letter from NSW Health to Special Commission of Inquiry, 31 October 2008.
 - ⁸ Letter from NSW Health to Special Commission of Inquiry, 31 October 2008.
 - ⁹ Letter from NSW Health to Special Commission of Inquiry, 31 October 2008.
 - ¹⁰ Not all registrars are training to become specialists as the term 'registrar' is an industrial classification that applies to positions covered by the Award whether they are specialist training positions or not. However, the term registrar is used in this report to refer to those doctors who are registered as trainees with the specialist Colleges, as this is the usual meaning of the term in the hospital system.
 - ¹¹ NSW Health, *Presentation to Special Commission of Inquiry: NSW Health Workforce*, 4 April 2008, p.3.

-
- ¹² Letter from NSW Health to Special Commission of Inquiry, 11 February 2008. Source: NSW Department of Health, Health Information Exchange. Payroll information is not separated into acute care and other sectors (including community).
- ¹³ Information provided during visit to Wollongong Hospital on 14 April 2008.
- ¹⁴ Clause 16, Public Hospital Career Medical Officers (State) Award.
- ¹⁵ Submission of the Australian Medical Association (NSW) Limited and the Australian Salaried Medical Officers' Federation, 28 March 2008, SUBM.016.0015 at 18.
- ¹⁶ Institute of Medical Education and Training, *Hospital Skills Program – A pilot program for non-specialist doctors and General Practitioners in NSW Emergency Departments*, March 2007.
- ¹⁷ Institute of Medical Education and Training, *Hospital Skills Program – A pilot program for non-specialist doctors and General Practitioners in NSW Emergency Departments*, March 2007.
- ¹⁸ NSW Health briefing, Professor Peter Castaldi AO, 4 April 2008, transcript 120.15.
- ¹⁹ Submission of the Australian Medical Association (NSW) Limited and the Australian Salaried Medical Officers' Federation, 28 March 2008, SUBM.016.0015 at 18; Confidential submission, 7 April 2008, SUBM.036.0087 at 3.
- ²⁰ Confidential submission, 7 April 2008, SUBM.036.0087 at 3.
- ²¹ NSW Department of Health *Annual Report 2006/07* page iii.
- ²² Information provided during visit to Ryde Hospital on 12 March 2008.
- ²³ Information provided during visit to Ryde Hospital on 12 March 2008.
- ²⁴ Meeting with the Royal Australasian College of Physicians, 24 June 2008.
- ²⁵ Meeting with the Royal Australasian College of Physicians, 24 June 2008.
- ²⁶ Submission of the Australian Medical Association (NSW) Limited and the Australian Salaried Medical Officers' Federation, 28 March 2008, SUBM.016.0015 at 18.
- ²⁷ NSW Health fact sheet, provided under letter from NSW Health dated 10 October 2008.
- ²⁸ NSW Health briefing, 13 March 2008, transcript 10.37.
- ²⁹ NSW Health briefing, 13 March 2008, transcript 10.42.
- ³⁰ NSW Health, *Presentation to Special Commission of Inquiry: NSW Health Workforce*, 4 April 2008, p.3.
- ³¹ NSW Health, *Presentation to Special Commission of Inquiry: NSW Health Workforce*, 4 April 2008, p.3.
- ³² Meeting with NSW Institute of Medical Education and Training, 3 April 2008, transcript 42.26.
- ³³ Submission of Rural Doctors Network, 25 March 2008, SUBM.003.0012 at p.2.
- ³⁴ Health Workforce Queensland and New South Wales Rural Doctors Network (2008). *Medical practice in rural and remote Australia: National Minimum Data Set report as at 30th November 2007, 2008*, Brisbane: HWQ, Table 10.
- ³⁵ Submission of Rural Doctors Network, 25 March 2008, SUBM.003.0012 at p.5.
- ³⁶ Submission of Rural Doctors Network, 25 March 2008, SUBM.003.0012 at p.5.
- ³⁷ Dr Scott Whyte, Gosford hearing, 10 March 2008, at 103-104.
- ³⁸ Specialists report accounting for 37.3% of the total medical workforce in 2006. (Source: Profile of the Medical Workforce in NSW).
- ³⁹ Payroll information is not separated into acute care and other sectors (including community). Review of payroll data identifies a total of 2203 FTE staff specialists and 4677 headcount Visiting Medical Officers – a total of 6880 as a minimum. (Source: HIE as at September 2007 and VMO data 06/07)). The annual Registration Board self reported survey identifies 6,170 specialists who reported working in NSW in 2006. Of these, 5,927 reported working in acute care services (96%).
- ⁴⁰ NSW Health Briefing, 4 April 2008, transcript 64.12; NSW Health, *Presentation to Special Commission of Inquiry: NSW Health Workforce*, 4 April 2008, p. 3.

-
- ⁴¹ For example, submission of Dr A Pesce, Westmead Medical Staff Council, undated, SUBM.013.0089 at 98; Submission of Dr Sydney Nade, 22 February 2008, SUBM.013.0001 at 5, paragraph 23; Submission of the Wyong and Gosford Medical Staff Councils, March 2008, SUBM.002.0050 at 52.
- ⁴² NSW Health, Profile of the Medical Workforce, 2005, DOH.045.0311, at 11.
- ⁴³ NSW Health, Profile of the Medical Practitioner Workforce in NSW, 2006.
- ⁴⁴ Confidential submission, 5 April 2008, SUBM.013.0065.
- ⁴⁵ Submission of the Australian Medical Association (NSW) Limited and the Australian Salaried Medical Officers' Federation, 28 March 2008, SUBM.016.0015 at 19.
- ⁴⁶ Confidential Westmead Children's Hospital hearing, 15 May 2008, transcript 13.38.
- ⁴⁷ Meeting with Royal Australasian College of Physicians, 24 June 2008.
- ⁴⁸ Andrew Dix, Chief Executive Officer and Registrar of the Medical Board of New South Wales, on-site hearing, 12 June 2008, transcript 59.8.
- ⁴⁹ Submission of the Royal College of Pathologists of Australasia, 31 March 2008, SUBM.014.0121, at 124; Confidential submission, 31 March 2008, SUBM.014.0253; Submission of the Australian and New Zealand College of Anaesthetists; Confidential submission, SUBM.070.0273, at 278, 279; Confidential submission, 25 March 2008, SUBM.006.0232 at 2.
- ⁵⁰ Meeting with the Royal Australasian College of Physicians, 24 June 2008.
- ⁵¹ Australian Competition and Consumer Commission and Australian Health Workforce Officials' Committee, Report to Australian Health Ministers - Review of Australian specialist medical colleges, 2005, Commonwealth of Australia 2005, ACCC Publishing Unit, ACT at 26.
- ⁵² Australian Competition and Consumer Commission and Australian Health Workforce Officials' Committee, Report to Australian Health Ministers - Review of Australian specialist medical colleges, 2005, Commonwealth of Australia 2005, ACCC Publishing Unit, ACT at 26.
- ⁵³ Dr Richard Cracknell, Liverpool hearing, 17 April 2008, transcript 1850.
- ⁵⁴ See Chapter 20.
- ⁵⁵ Submission of the Australian Medical Association (NSW) Limited and the Australian Salaried Medical Officers' Federation, 28 March 2008, SUBM.017.0143, Annexure N.
- ⁵⁶ Productivity Commission 2005, Australia's Health Workforce, Research Report, Canberra at xiv.
- ⁵⁷ Submission of the Australian and New Zealand College of Anaesthetists, March 2008, SUBM.053.0196, at 11.
- ⁵⁸ Letter from NSW Health to Special Commission of Inquiry, 10 October 2008, Annexure E.
- ⁵⁹ Letter from NSW Health to Special Commission of Inquiry, 10 October 2008, Annexure E1.
- ⁶⁰ Commonwealth of Australia, eleventh annual report of the Medical Training Review Panel, 2008, tables 4.26 and 4.27.
- ⁶¹ Meeting with the Institute of Medical Education & Training, 3 April 2008, transcript 86.16.
- ⁶² Letter from NSW Health to Special Commission of Inquiry, 10 October 2008, Annexure A.
- ⁶³ For example, Submission of the NSW Medical Staff Executive Council, 28 March 2008, SUBM.034.0056, at 6.
- ⁶⁴ Scott M et al; "Brain drain" or ethical recruitment?" (2004) 180 Medical Journal of Australia 174, http://www.mja.com.au/public/issues/180_04_160204/sco10883_fm.html (17 November 2008); Worley PS, The ethics of international recruitment (2002) Rural and Remote Health online, no.196, http://www.regional.org.au/au/rrh/editorial/ed_14.htm#TopOfPage (17 November 2008).
- ⁶⁵ Provided by the Institute of Medical Education & Training, 4 April 2008.
- ⁶⁶ Medical Deans Australia and New Zealand, *National Clinical training Review, Report to the Medical Training Review Panel Clinical Training Sub-Committee*, February 2008, SUBM.024.0005.

-
- 67 Submission of the NSW Medical Staff Executive Council, 28 March 2008, SUBM.034.0056, at 6.
- 68 Professor Bruce Robinson, Meeting with the Medical Deans of Australian and New Zealand, 13 August 2008.
- 69 Dr Gregory Keogh, Expert conference, 15 September 2008, transcript 34.26.
- 70 Submission of the Australian Medical Association (NSW) Limited and the Australian Salaried Medical Officers' Federation (NSW), 28 March 2008, SUBM.016.0015 at 17.
- 71 Submission of the Directors of the Institute of Medical Education and Training, 2 April 2008, IMET.008.0001.
- 72 Submission of the Royal College of Pathologists of Australasia, 31 March 2008, SUBM.014.0121, at 4.
- 73 Submission of the Australian Medical Association (NSW) Limited and the Australian Salaried Medical Officers' Federation (NSW), 28 March 2008, SUBM.016.0015 at 17.
- 74 Meeting with the Institute of Medical Education & Training, 3 April 2008, transcript 79.42.
- 75 Dr William Monroe, Gosford hearing, 10 March 2008, transcript 117.19.
- 76 Meeting with the Australian and New Zealand College of Anaesthetists, 24 June 2008.
- 77 Medical Deans Australia and New Zealand, *National Clinical training Review, Report to the Medical Training Review Panel Clinical Training Sub-Committee*, February 2008, SUBM.024.0005 at 9.
- 78 Submission of the NSW Medical Staff Executive Council, 28 March 2008, SUBM.034.0056, at 62.
- 79 Commonwealth Department of Health and Family Services, Trainee Selection in Australian Medical Colleges, 1998, Publications Production Unit.
- 80 Confidential submission, 31 March 2008, SUBM.014.0253 at 254; Confidential submission, SUBM.070.0273 at 278, 279; Confidential submission, 25 March 2008, SUBM.006.0232 at 233.
- 81 Submission of the Australian and New Zealand College of Anaesthetists, 28 March 2008, SUBM.015.0023, at 7.
- 82 Submission of the Royal College of Pathologists of Australasia, 31 March 2008, SUBM.014.0121, at 4.
- 83 Meeting with the Royal Australasian College of Physicians, 24 June 2008.
- 84 Confidential submission, 25 March 2008, SUBM.006.0232 at 2.
- 85 Dr Suzanne Hodgkinson, Liverpool Hospital hearing, 17 April 2008, transcript 1863.21; Dr James Branley, Nepean Hospital hearing, 8 April 2008, transcript 1332.42; Dr Michael Brydon, Sydney Children's Hospital, 19 May 2008, transcript 3050.1.
- 86 NSW Health, Health Information Exchange.
- 87 Dr Michael Brydon, Sydney Children's Hospital, 19 May 2008, transcript 3049.30.
- 88 NSW Health briefing, 13 March 2008, transcript 88.41.
- 89 NSW Health briefing, 13 March 2008, transcript 88.47.
- 90 Dr Michael Brydon, Sydney Children's Hospital, 19 May 2008, transcript 3049.30.
- 91 Dr James Branley, Nepean Hospital hearing, 8 April 2008, transcript 1332.42; Dr Suzanne Hodgkinson, Liverpool Hospital hearing, 17 April 2008, transcript 1863.21.
- 92 Items 132 and 133: see Fact Sheet for New Consultant Physician Items for November 2007, Commonwealth Department of Health and Ageing (<http://www.health.gov.au/internet/mbsonline/publishing.nsf/Content/MBSOnline-News-Consultant-Physician-Fact-Sheet>) (October 2008).
- 93 Submission of the Wyong and Gosford Medical Staff Councils, March 2008, SUBM.002.0050, 2.
- 94 Meeting with Australasian Society of Career Medical Officers, 24 June 2008.
- 95 Confidential hearing, 13 June 2008, transcript 2.
- 96 Meeting with the Royal Australasian College of Physicians, 24 June 2008.

-
- 97 Dr Ian Gough, "Subspecialisation in surgery and the continuing challenge of providing emergency surgery services" (2008) 189(7) *The Medical Journal of Australia* 358-359.
- 98 Meeting with Royal Australasian College of Surgeons, 25 June 2008.
- 99 At 31, 60
- 100 Dr Ian Gough, "Subspecialisation in surgery and the continuing challenge of providing emergency surgery services" (2008) 189(7) *The Medical Journal of Australia* 358-359.
- 101 Royal Australasian College of Surgeons, Annual Activities Report, 2004, at 6; Royal Australasian College of Surgeons, Annual Activities Report, 2007, at 42.
- 102 Royal Australasian College of Surgeons, Annual Activities Report, 2007.
- 103 Meeting with the Medical Deans of Australia and New Zealand, 13 August 2008.
- 104 NSW Health briefing, 4 April 2008, transcript 55.
- 105 Royal Australasian College of Surgeons, 'Training for GP Surgical Proceduralists', approval date: October 2007.
- 106 The members of the JCCS are the Royal Australasian College of Surgeons, the Australian College of Rural and Remote Medicine, and the Royal Australian College of General Practitioners.
- 107 University of Sydney, Working Conditions of Doctors and Nurses in NSW Public Hospitals, Survey for Submission to the Garling Inquiry, Workplace Research Centre, University of Sydney, 20 March 2008 at 9; Meeting with NSW Medical Staff Executive Council, 26 June 2008.
- 108 Meeting with NSW Medical Staff Executive Council, 26 June 2008.
- 109 Confidential submission, 11 June 2008, SUBM.074.0064; Dr Stephen Hunyor, Royal North Shore Hospital hearing, 14 March 2008, transcript 298.7.
- 110 Confidential submission, 11 June 2008, SUBM.074.0064; Dr Stephen Hunyor, Royal North Shore Hospital hearing, 14 March 2008, transcript 298.7.
- 111 Confidential submission, 11 June 2008, SUBM.074.0064 at 2.
- 112 Confidential Concord Hospital hearing, 24 April 2008.
- 113 Dr Peter Rankin, 31 March 2008, SUBM.014.0014 at 3.
- 114 Dr Peter Collett, Liverpool hearing, 17 April 2008, transcript 1817.13; Submission of Dr Peter Collett, 17 April 2008, SUBM.069.0223.
- 115 Submission of the Australian Medical Association (NSW) Limited and the Australian Salaried Medical Officers' Federation, 28 March 2008, SUBM.017.0114, Annexure J.
- 116 For example, Submission of Dr Christopher Arthur, 28 March 2008, SUBM.001.0211.
- 117 For example, Submission of Dr Christopher Arthur, 28 March 2008, SUBM.001.0211; Submission of Dr Lisa Mohanlal and others, 7 May 2008, SUBM.046.0122 at 2; Submission of Senior Medical Staff at Sydney Children's Hospital, 26 March 2008, SUBM.001.0001 at 2; Submission of Emeritus Professor Ian Webster, 26 March 2008, SUBM.015.0235 at 4.
- 118 Submission of Dr Lisa Mohanlal and others, 7 May 2008, SUBM.046.0122 at 2.
- 119 University of Sydney, Working Conditions of Doctors and Nurses in NSW Public Hospitals, Survey for Submission to the Garling Inquiry, Workplace Research Centre, University of Sydney, 20 March 2008 at 7.
- 120 Australian Medical Association, *National Code of Practice – Hours of Work, Shiftwork and Rostering for Hospital Doctors*, 1999.
- 121 Australian Medical Association, *Safe Hours = Safe Patients*, AMA Safe Hours Audit 2006, October 2006.
- 122 'Safe Hours – Keeping you and your patients safe' E_dit Issue 53, 15 April 2008 at <http://www.ama.com.au/web.nsf/doc/WEEN-7FS78M> (accessed October 2008).
- 123 Submission of Drs Bullmore and Brownlow, undated, SUBM.002.0210 at 2.
- 124 Confidential Concord hearing, 14 April 2008
- 125 Australian Medical Association, *Risk Assessment of Junior Doctor Rosters*, July 2001.

-
- ¹²⁶ NSW Health, *Fatigue – Preventing & Managing Work Related Fatigue: Guidelines for the NSW public Health System*, GL2007_023.
- ¹²⁷ Information provided during visit to Mullumbimby Hospital, 29 April 2008.
- ¹²⁸ Confidential Concord Hospital hearing, 14 April 2008; Drs Tan, Phipps, Hsu, Westmead Hospital hearing, 10 April 2008, transcript 1492.14; Confidential submission, 23 April 2008, SUBM.023.0122.
- ¹²⁹ Dr Phipps, Westmead Hospital hearing, 10 April 2008, transcript 1492.47-14.
- ¹³⁰ Dr Phipps, Westmead Hospital hearing, 10 April 2008, transcript 1492.14.
- ¹³¹ Submission of Drs Bullmore and Brownlow, undated, SUBM.002.0210 at 8.
- ¹³² Submission of Drs Bullmore and Brownlow, undated, SUBM.002.0210 at 8.
- ¹³³ NSW Health, *Medical Officers - Employment Arrangements in the NSW Public Health System*, PD2007_087.
- ¹³⁴ Public Hospital Medical Officers Award.
- ¹³⁵ Dr Ian Incoll, Gosford hearing, 10 March 2008, transcript 44.40
- ¹³⁶ Associate Professor David Baines, The Children's Hospital at Westmead hearing, 15 May 2008, transcript 2910.
- ¹³⁷ Submission of the Australian Medical Association (NSW) Limited and the Australian Salaried Medical Officers' Federation, 28 March 2008, SUBM.016.0015 at 19.
- ¹³⁸ Submission of the Australian Medical Association (NSW) Limited and the Australian Salaried Medical Officers' Federation, 28 March 2008, SUBM.016.0015 at 21.
- ¹³⁹ Statement of Therese Mary McGee, provided in the Submission of the Australian Medical Association (NSW) Limited and the Australian Salaried Medical Officers' Federation, 28 March 2008, SUBM.016.0015.
- ¹⁴⁰ NSW Health, *Visiting Medical Officers – Remuneration*, PD2007_032.
- ¹⁴¹ Dr Therese McGee, Westmead Hospital hearing, 10 April 2008, transcript 1532.26.
- ¹⁴² Submission of the Australian Medical Association (NSW) Limited and the Australian Salaried Medical Officers' Federation, 28 March 2008, SUBM.016.0015 at 20; Information provided during visit to Broken Hill Hospital on 7 May 2008.
- ¹⁴³ Meeting with NSW Health, 4 April 2008, transcript 64.12.
- ¹⁴⁴ Confidential St Vincent's Hospital hearing, 30 April 2008, transcript 12.4.
- ¹⁴⁵ Letter from NSW Health to Special Commission of Inquiry, 31 October 2008.
- ¹⁴⁶ Dr Denis Smith, Broken Hill hearing, 7 May 2008, transcript 2629; Dr Gary Baker, Armidale hearing, 26 March 2008, transcript 874; Dr Theresa Beswick, Coffs Harbour hearing, 27 March 2008, transcript 1038.36; Dr Andrew Munro, Coffs Harbour hearing, 27 March 2008, transcript 1022.23-32; Dr William Monroe, Gosford hearing, 10 March 2008, transcript 113.20-32; Information provided during visits to Wollongong Hospital on 14 April 2008, Kempsey District Hospital on 27 March 2008, Broken Hill Hospital on 7 May 2008 and Bourke Hospital on 8 May 2008.
- ¹⁴⁷ Submission of Dr Diane Campbell, 29 March 2008, SUBM.022.0013.
- ¹⁴⁸ Submission of Dr Peter Rankin, 31 March 2008, SUBM.014.0014.
- ¹⁴⁹ Confidential Tweed Hospital hearing by video-link, 29 May 2008, 12.15.
- ¹⁵⁰ Dr Simon Battersby, Gosford hearing, 10 March 2008, transcript 160.32.
- ¹⁵¹ Dr Peter Finlayson, Tamworth hearing, 25 March 2008, transcript 824.20.
- ¹⁵² Dr Louis Christie, Orange hearing, 18 March 2008, transcript 533.24.
- ¹⁵³ Dr Denis Smith, Broken Hill hearing, 7 May 2008, transcript 2629.
- ¹⁵⁴ Submission of Dr Alan Tankel, 25 March 2008, SUBM.030.0003 at 3.
- ¹⁵⁵ Letter from NSW Health to Special Commission of Inquiry, 5 November 2008.
- ¹⁵⁶ Information provided during visit to Ballina Hospital 28 April 2008; Confidential Tweed Heads hearing by video-link, 29 May 2008, 11.44.
- ¹⁵⁷ Dr Denis Smith, Broken Hill Hospital, 7 May 2008, transcript 2629.

-
- 158 Submission of Dr Diane Campbell, 29 March 2008, SUBM.022.0013.
- 159 Confidential Sydney Children's Hospital hearing, 19 May 2008; Dr Denis Smith, Broken Hill hearing, 7 May 2008, transcript 2629.
- 160 Dr Louis Christie, Orange hearing, 18 March 2008, transcript 533.
- 161 Submission of Dr Andrew Hooper, 30 March 2008, SUBM.008.0017.
- 162 Submission of Dr Alan Tankel, 25 March 2008, SUBM.030.0003 at 3.
- 163 Dr Simon Battersby, Gosford Hospital hearing, 10 March 2008, transcript 162.
- 164 Submission of Dr Alan Tankel, 25 March 2008, SUBM.030.0003.
- 165 Submission of Dr Diane Campbell, 29 March 2008, SUBM.022.0013; Dr Theresa Beswick, Coffs Harbour hearing, 27 March 2008, transcript 1039.14.
- 166 Submission of Dr Diane Campbell, 29 March 2008, SUBM.022.0013.
- 167 Lyndall Morris, Broken Hill hearing, 7 May 2008, transcript 2664.43.
- 168 Dr Denis Smith, Broken Hill hearing, 7 May 2008, transcript 2632.23.
- 169 Dr Denis Smith, Broken Hill hearing, 7 May 2008, transcript 2629; Submission of Dr Diane Campbell, 29 March 2008, SUBM.022.0013.
- 170 Dr Denis Smith, Broken Hill Hospital hearing, 7 May 2008, transcript 2629.
- 171 Section 127A, *Medical Practice Act 1992* (NSW).
- 172 Andrew Dix, Chief Executive Officer and Registrar of the Medical Board of New South Wales, 12 June 2008, transcript 60.17.
- 173 eg Australian and New Zealand College of Anaesthetists, Royal Australasian College of Surgeons.
- 174 Alan Pretty, Port Macquarie Hospital, 28 March 2008, transcript 1117.
- 175 Dr Simon Battersby, Gosford hearing, 10 March 2008, transcript 162.24.
- 176 Dr Theresa Beswick, Coffs Harbour hearing, 27 March 2008, transcript 1038.40.
- 177 Dr Denis Smith, Broken Hill hearing, 7 May 2008.
- 178 Confidential Coffs Harbour hearing, 27 March 2008, transcript 12.36.
- 179 Kerry J Goulston, Clare A Skinner, Rebecca L Riordan, Kylie L Fraser, John D Buchanan "The challenge of locum working arrangements in New South Wales public hospitals" (2006) 185(5) *Medical Journal of Australia* 276-278.
- 180 Meeting with the Greater Metropolitan Clinical Taskforce, 15 July 2008; Meeting with the Australian Medical Association and the Australian Federation of Salaried Medical Officers, 23 June 2008.
- 181 NSW Health briefing, 4 April 2008, transcript 64.27.
- 182 Letter from NSW Health to Special Commission of Inquiry, 31 October 2008.
- 183 Dr Peter Finlayson, Tamworth hearing, 25 March 2008, transcript 824.3.
- 184 Letter from NSW Health to Special Commission of Inquiry, 28 October 2008.
- 185 Dr Nicholson Stephenson, Wagga hearing, 22 April 2008, transcript 2019.
- 186 Dr Richard Cracknell, Liverpool hearing, 17 April 2008, transcript 1850.27.
- 187 Dr Richard Cracknell, Liverpool hearing, 17 April 2008, transcript 1850.27.
- 188 Professor Sandy Reid, Wagga Wagga hearing, 22 April 2008, transcript 1903.37.
- 189 NSW Health, *Rates of Pay, Overseas Trained Medical Officers*, PD2005_471.
- 190 For example, Liverpool Hospital Mental Health Unit, information provide during visit on 17 April 2008.
- 191 Australian Medical Council, International Medical Graduates, www.amc.org.au.
- 192 Douglas, S, "The registration and accreditation of international medical graduates in Australia – a broken system or a work in progress?" (2008) 16(2) *People and Place* 28(13).
- 193 Information provided during visit to Liverpool Hospital Mental Health Unit on 17 April 2008.
- 194 Dr Richard Cracknell, Liverpool hearing, 17 April 2008, transcript 1851.1.

-
- 195 Confidential Sydney Children's Hospital hearing, 19 May 2008.
- 196 Dr Richard Cracknell, Liverpool hearing, 17 April 2008, transcript 1851.
- 197 Dr James Branley, Nepean hearing, 8 April 2008, 1331.4.
- 198 Professor Sandy Reid, Wagga Wagga hearing, 22 April 2008, transcript 1904.
- 199 Professor Sandy Reid, Wagga Wagga hearing, 22 April 2008, transcript 1902.
- 200 Dr William Monroe, Gosford hearing, 10 March 2008, transcript 113.34.
- 201 Dr Atkin Pitsoe, Wagga Wagga hearing, 22 April 2008, transcript 1949.
- 202 Dr Amer Sultan, hearing by video link, 13 June 2008, transcript 3294.8.
- 203 Dr Atkin Pitsoe, Wagga Base Hospital hearing, 22 April 2008, transcript 1938.
- 204 Dr Atkin Pitsoe, Wagga Wagga hearing, 22 April 2008, transcript 1942.29-32.
- 205 PD2005_180, issued on 11 August 2000.
- 206 NSW Health, *Medical Officers - Employment Arrangements in the NSW Public Health System*, PD2007_087.
- 207 NSW Health, *Medical Officers - Employment Arrangements in the NSW Public Health System*, PD2007_087.
- 208 NSW Health, *Postgraduate Medical Council of NSW - Role and Responsibility*, PD2005_143.
- 209 Meeting with the Institute of Medical Education and Training, 3 April 2008, transcript 33.1.
- 210 Meeting with the Institute of Medical Education and Training, 3 April 2008, transcript 28.5.
- 211 Meeting with the Institute of Medical Education and Training, 3 April 2008, transcript 27.23.
- 212 Meeting with the Institute of Medical Education and Training, 3 April 2008, transcript 27.23.
- 213 Letter from Professor Mark Brown, Director to Catherine Follent, Special Commission of Inquiry, 22 October 2008.
- 214 Meeting with the Institute of Medical Education and Training, 3 April 2008, transcript 28.37.
- 215 Meeting with the Institute of Medical Education and Training, 3 April 2008, transcript 27.46.
- 216 NSW Health, *Medical Officers - Employment Arrangements in the NSW Public Health System*, PD2007_087.
- 217 NSW Health, *Medical Officers - Employment Arrangements in the NSW Public Health System*, PD2007_087.
- 218 Letter from Institute of Medical Education and Training to Special Commission of Inquiry, 22 October 2008.
- 219 NSW Health, *Medical Officers - Employment Arrangements in the NSW Public Health System*, PD2007_087.
- 220 Letter from Institute of Medical Education and Training to Special Commission of Inquiry, 22 October 2008.
- 221 NSW Health, *Performance Review of Visiting Practitioners: Policy for implementation (2005)*, PD2005_498, p.7.
- 222 NSW Health, *Staff Specialists – Appointment*, PD2005_500.
- 223 Staff Specialists (State) Award.
- 224 NSW Health, *Staff Specialists – Appointment*, PD2005_500.
- 225 NSW Health, *Staff Specialists – Appointment*, PD2005_500.
- 226 Meeting with the Institute of Medical Education and Training, 3 April 2008, transcript 64.30.
- 227 See for example, "Managing the clinical performance of doctors" (1999) 20 *British Medical Journal* 1314–1315.
- 228 Meeting with Institute of Medical Education and Training, 3 April 2008.
- 229 Clinical Excellence Commission, The Clinical Leadership Program, <http://www.cec.health.nsw.gov.au/moreinfo/CLP.html> (18 November 2008).
- 230 For example, Dr Gregory Purcell, Royal North Shore Hospital hearing, 14 March 2008, transcript 415.27; Submission of Dr Fergus Davidson, 28 March 2008, SUBM.039.0021 at 2;

Confidential submission, 28 March 2008, SUBM.018.0014; Submission of Professor PM Davidson, 27 March 2008, SUBM.004.0020 at 6.

²³¹ Submission of Dr Fergus Davidson, 28 March 2008, SUBM.039.0021 at 1.

²³² Confidential submission, 28 March 2008, SUBM.018.0014; Submission of Dr Stephen Barratt, 28 March 2008, SUBM.035.0088 at 10; Submission of Dr Fergus Davidson, 28 March 2008, SUBM.039.0021 at 2.

²³³ Submission of Dr Stephen Barratt, 28 March 2008, SUBM.035.0088 at 10.

²³⁴ Submission of Dr Stephen Barratt, 28 March 2008, SUBM.035.0088 at 10.

²³⁵ Submission of Dr Fergus Davidson, 28 March 2008, SUBM.039.0021 at 2.

²³⁶ Submission of Dr Fergus Davidson, 28 March 2008, SUBM.039.0021 at 2.

²³⁷ Meeting with Alan McCarroll, 19 February 2008.

²³⁸ For example, confidential hearing, 13 June 2008, transcript 2; Dr Maxwell Coleman, St Vincent's Hospital hearing, 30 April 2008, transcript 2441.29.

²³⁹ Dr Gregory Purcell, Royal North Shore Hospital hearing, 14 March 2008, transcript

²⁴⁰ Ms Kate Needham, Meeting with Greater Metropolitan Clinical Taskforce (GMCT), 7 March 2008.

²⁴¹ Dr Keogh, Experts' conference, 15 September 2008, transcript 22.1.

²⁴² Professor Peter Castaldi AO, Experts' Conference, 15 September 2008, transcript 24.6.

²⁴³ CEC Project Summaries 2007/2008.

8 Nurses

Nursing in NSW	243
Registered Nurses	243
Midwives	244
Enrolled Nurses	244
Assistants-in-Nursing.....	244
Clinical Nurse Educators	245
Clinical Nurse Specialists	245
Clinical Nurse Consultants	245
Clinical Initiatives Nurse	246
Nurse Unit Managers / Midwifery Unit Managers.....	246
Nurse Practitioners	246
The struggle of change.....	247
An ageing workforce	248
Do we have enough nurses?	249
Efforts to recruit more nurses	251
Administrative over-burdening of Nurse Unit Managers	253
Roles and remuneration	253
Tasks undertaken by Nurse Unit Managers	254
Loss of clinical role	258
Solutions	259
Remuneration	262
Understaffing	263
Contributing factors	266
Reasonable workloads	267
Skill mix	269
Consequences of understaffing and junior skill mix	269
Solutions.....	270
Changing roles for nurses	271
Resistance from other health professionals	271
Resistance from nurses.....	272
Examples from the United Kingdom	272
In the operating theatre	273
Nurse practitioners	274
Response of other health professionals	275
Future of nurse practitioners	276

- 8.1 In this chapter, I will examine a number of significant issues that arose during the course of the Inquiry in relation to nurses, namely:
- (a) the emerging shortage of nurses, as the existing workforce ages and is not being adequately replaced;
 - (b) the administrative over-burdening of nurse unit managers;
 - (c) a defective pay scale for nurses who continue to work “at the bedside” beyond 8 years of service;
 - (d) understaffing;
 - (e) a lack of experienced nursing staff (or “skill mix”); and
 - (f) changing roles for nurses into the future, in particular, nurse practitioners.
- 8.2 Elsewhere in my report, I have also dealt with the following issues concerning nurses:
- (a) issues particular to midwives in Chapter 4;
 - (b) the distribution of the nursing workforce in rural and remote areas in Chapter 6;
 - (c) continuing education and training in Chapter 10;
 - (d) a lack of support staff, including ward clerks, in Chapter 11;
 - (e) bullying and workplace culture in Chapter 12; and
 - (f) supervision of junior nurses in Chapter 13.

Nursing in NSW

- 8.3 Nurses in NSW public hospitals have “24/7” contact with patients and are responsible for many aspects of their care.¹
- 8.4 There are some 30 different nurse specialties, including medical, surgical, midwifery, mental health, emergency, intensive care, child and family health, women’s health and community health.²
- 8.5 Various types of nursing roles have developed in response to the broad range of tasks undertaken by nurses, which I will discuss in detail below. Overall, 82 to 84% of the nursing workforce employed in NSW public hospitals are registered nurses,³ and about 16 to 18% are not registered nurses.⁴ The following table sets out the proportion of nurses by type employed by NSW Health:⁵

Table 8.1 Nursing Full Time Equivalent (FTE) by type, NSW Health- as at June 2008

	total	percent
Assistant in Nursing –Student Nurse	75.4	0.2
Trainee Enrolled Nurse	883.4	2.2
Enrolled Nurse	5841.6	14.4
Registered Nurse (Jnr)	6204.3	15.3
Registered Nurse (Snr)	17,445.3	43.0
Clinical Nurse Specialist	4109.5	10.1
Clinical Nurse Educator	385.1	0.9
Nurse Educator	211.7	0.5
Clinical Nurse Consultant	1425.5	3.5
Nurse Practitioner	68.5	0.2
Nursing Unit Manager	1641.5	4.0
Nurse Manager	1277.8	3.1
All other Nursing Awards	1042.5	2.6
Total Nurses	40,612.2	100

Source: DoH HIE state_staff_profile (includes Third Schedule Facilities and Agency Nurses)

Note: Registered Nurse (Junior) includes Registered Nurses Year 1 to Year 4.

Registered Nurse (Senior) includes Registered Nurses Year 5 to Year 8

Registered Nurses

- 8.6 Registered nurses are those registered in the Register of Nurses maintained by the NSW Nurses and Midwives Board.⁶
- 8.7 Registered nurses are generally educated at bachelor degree or post-graduate level at university.⁷ A typical NSW registered nurse is:
- female (92%),
 - 44.1 years old,
 - working in a clinical role (94%), and
 - working within a metropolitan area (65%).⁸

Midwives

- 8.8 Midwives provide support, care and advice during pregnancy, labour and after birth, as well as conducting births and providing care for newborns and infants.⁹ Registered midwives are registered in the Register of Midwives kept by the NSW Nurses and Midwives Board.¹⁰
- 8.9 I have discussed issues unique to midwives in Chapter 4, whilst issues common to midwives and other nurses are discussed in this chapter.

Enrolled Nurses

- 8.10 16% of NSW nurses are enrolled nurses,¹¹ being enrolled in List “A” of the Roll of Nurses kept by the NSW Nurses and Midwives Board.¹² To be enrolled in List “A”, a person must satisfy the Board that he or she has either undergone hospital training, has received the prescribed tuition, and passed the prescribed examinations or he or she has undertaken equivalent training.¹³
- 8.11 The majority of enrolled nurses educated in NSW in the last 20 years have undertaken certificate level courses in TAFE colleges, and obtained clinical experience in health and aged care facilities.¹⁴
- 8.12 NSW Health has now implemented an apprentice-style education program for trainee enrolled nurses.¹⁵ There are 1,026 candidates from 2008 Trainee Enrolled Nurse Program employed in NSW public hospitals,¹⁶ and 74% of these are likely to continue to work there after completing the program.¹⁷
- 8.13 A typical NSW enrolled nurse is:
- female (92.1%),
 - 43.2 years old,
 - working in a clinical role (98%), and
 - working within a metropolitan area (49.1%).¹⁸

Assistants-in-Nursing

- 8.14 Assistants-in-Nursing undertake basic nursing care.¹⁹ Elisabeth Allen told me at Coffs Harbour that assistants in nursing should be considered to ‘provide the basic care that nurses used to provide’.²⁰

“[AINs] would help a lot with basic patient care because, you know, that goes out the window when the acuity and, ... you know, PCAs and IVs and drains and drips and pain busters and epidurals and all of that kick in, the staff just don’t have the time and that’s what’s very sad to see lost, the basic patient care. That’s why we all went nursing and that’s what we’re passionate about and when patients don’t get their teeth brushed for a few days, you wouldn’t want it to happen to your parents or sister and that’s what saddens me about the whole way it’s gone.”²¹

- 8.15 Some certificate courses are available for prospective assistants-in-nursing, such as the Certificate III in Aged Care Work offered by TAFE NSW. The course is by distance-learning, involves 12 hours of study a week over one year and 50 hours work in an aged care facility.²²

Clinical Nurse Educators

- 8.16 Clinical nurse educators are tertiary-qualified registered nurses with at least 5 years relevant experience who assess, plan, implement and evaluate nursing education and professional evaluation programs.²³ To be a clinical nurse educator, a registered nurse must hold a relevant post-registration qualification.²⁴
- 8.17 Clinical nurse educators are responsible for the following:
- planning and developing syllabus structures and course programs for nursing education;
 - planning and participating in clinical education in hospitals, other health care facilities and community settings;
 - designing, implementing and evaluating educational programs and curricula for specialised nursing groups;
 - undertaking nursing research; and
 - maintaining an information base on educational programs.²⁵
- 8.18 The Director of Nursing at Gosford Hospital described the clinical nurse educators' role in the following terms:

"A clinical nurse educator is a nurse on the ward who is considered to be a specialist in his or her field, who has some capability of imparting knowledge to somebody else ... They need to be somebody who appreciates the needs of the novice and is able to support them through that workload."²⁶

Clinical Nurse Specialists

- 8.19 Clinical nurse specialists are registered nurses:
- with relevant post-basic qualifications and 12 months experience working in the clinical area of their specified post-basic qualification, *or*
 - with a minimum of 4 years post-basic registration experience including 3 years experience in the relevant specialist field, *and*
 - who satisfy the local criteria.²⁷
- 8.20 One clinical nurse specialist described the role as being that of a senior nurse who has a regular patient load and, in addition, is a resource person for new staff.²⁸

Clinical Nurse Consultants

- 8.21 Clinical nurse consultants are registered nurses appointed to clinical nurse consultant position by an area health service. In order to be appointed, the nurse must have at least 5 years full-time equivalent post-registration experience and hold approved post-registration nursing qualifications relevant to the field in which they are appointed, or other such qualifications or experience deemed appropriate by the area health service.²⁹
- 8.22 Clinical nurse consultants are involved in:³⁰
- clinical leadership in respect of policy, procedure, new initiatives and best practice for nursing,³¹
 - quality improvement, including working with doctors to implement new models of care,³²
 - clinical consultancy,

- education, and
- research.

Clinical Initiatives Nurse

- 8.23 Since 2002, Emergency Departments in some NSW public hospitals have installed clinical initiatives nurses, formalising what many Emergency Department nurses were doing on an *ad hoc* basis.³³
- 8.24 Clinical initiatives nurses are registered nurses who administer initial treatment and facilitate investigations, such as x-rays, in accordance with particular protocols.³⁴ Part of the role of the clinical initiatives nurse is to expedite the journey of the patient through the Emergency Department.³⁵ I have discussed the work of the clinical initiatives nurse further in Chapter 20.

Nurse Unit Managers / Midwifery Unit Managers

- 8.25 Nurse unit managers are registered nurses in charge of a ward or unit or group of wards or units in a hospital or health service.³⁶ Midwifery unit managers are in charge of maternity wards. My comments about nurse unit managers in this chapter apply equally to midwifery unit managers.
- 8.26 As at June 2008, 7.1% of NSW Health's full-time equivalent nursing workforce were nurse unit managers or Nurse Managers.³⁷
- 8.27 The responsibilities of nurse unit managers include:
- co-ordination of patient services;
 - unit management; and
 - management of nursing staff.³⁸
- 8.28 Generally, 5 years experience as an registered nurse is required for appointment to a nurse unit manager position.³⁹
- 8.29 I have discussed the roles of nurse unit managers further below, in particular, how they are presently overburdened with administrative tasks.
- 8.30 Nurse managers are registered nurses who are appointed to a management role either for a group of wards or units in a hospital or community-based service.⁴⁰ I have been told that a number of area health services have also chosen to appoint nurse managers to critical care areas due to their size and complexity.⁴¹ A more senior position than "nurse unit manager", I am told that nurse managers are expected to have the ability to develop an environment that promotes continuous improvement in nursing practice.⁴² Nurse managers may also have some funding allocation responsibility.⁴³

Nurse Practitioners

- 8.31 Nurse practitioners are nurses authorised by the NSW Nurses and Midwives Board under the *Nurses and Midwives Act 1991* (NSW) to practise as nurse practitioners.⁴⁴ Nurse practitioners have an advanced level of knowledge and the ability to make complex clinical decisions that would not be expected of most registered nurses.⁴⁵ Nurse practitioners may be authorised to prescribe medications.⁴⁶
- 8.32 Nurse practitioners are generally educated at masters degree level and are required to demonstrate a certain level of experience to attain authorisation.⁴⁷

- 8.33 Applications for authorisation to practice as nurse practitioners are assessed in relation to a nursing field of the applicant's choice, with the majority assessed in mental health, high dependency (emergency) nursing and primary health care.⁴⁸ A smaller number of applicants have been assessed in paediatrics, medical/surgical nursing, maternal and child health and rehabilitation nursing.⁴⁹
- 8.34 I have discussed the emerging role of the nurse practitioner further below.

The struggle of change

- 8.35 There has been a number of major changes to the education and supervision of nurses in NSW public hospitals over the last several years which are still working their way through nursing culture.

Hospital versus university training

- 8.36 Firstly, there appears to be something of a clash of approach and culture between senior nurses, who have been solely trained in the hospital environment, and junior nurses who have been training in a university environment and come to the ward with very little practical experience. The perception of some hospital-trained nurses is that university-trained nurses lack the practical education that would properly equip them for the ward environment. One 4th year registered nurse described it in the following terms:

"...A lot of the nurses that work within hospitals - we do have an ageing workforce - they were hospital trained. They have a very poor vision of university trained nurses. They don't think they are professional. That's something that will be struggled with for years, I think ..."

- 8.37 Whilst I acknowledge the tension between the way that different nurses gained their initial grounding in nursing, modern workplaces demand the best trained staff. The university based training fulfils that demand and is the way of the future for the majority of our nurses. This does not detract from the valuable knowledge and experience of our hospital-trained nurses.

Matrons

- 8.38 For many years, nurses in a particular hospital were overseen by a matron, who became known in more recent years as the Director of Nursing. The matron managed the nurses under her charge, and in addition provided clinical guidance and oversight. As such, the matron performed a role that was something of a fusion of the present-day nurse unit manager and clinical nurse educator.
- 8.39 Recently, administration in hospitals has moved from hospital-based management to area health service-based management. Generally, this has meant that the Director of Nursing position no longer exists for hospitals, although some hospitals still have one.
- 8.40 Some witnesses lamented the loss of the Director of Nursing structure, on the basis that reporting lines have become unclear: there is no matron within the hospital to see or call to deal with a nursing problem. The Acting Director of Nursing and Midwifery at Royal North Shore Hospital expressed this concern in the following way:

"Previously nurses reported to the directors of nursing within particular facilities. They now only have a professional line to the director of nursing and they have a direct reporting line to a divisional manager who may or may not have a nursing background."

That change has posed difficulties for the directors of nursing in trying to maintain standards of care across a whole facility to ensure that there is a consistent standard of care. It is often quite diversified within the different divisions. It is very much person-centred, person-reliant, I suppose, in that unless there is a nurse within that division who ensures the directors of nursing are kept informed and notifies them of any issues they might have around nursing care and nursing practice, the director of nursing quite often doesn't hear about anything until it becomes an incident."⁵¹

- 8.41 In my view, governance of the nursing profession has moved on from the traditional 'matron' structure, and notwithstanding the many calls which I received to reinstate the position of Matron, I do not recommend that this occur.

An ageing workforce

Page 248

- 8.42 The nursing workforce in NSW public hospitals is ageing.
- 8.43 The proportion of NSW nurses in older age groups can be seen from the following chart setting out the number of registered nurses and registered midwives according to the NSW Nurses and Midwives Board's database.⁵²

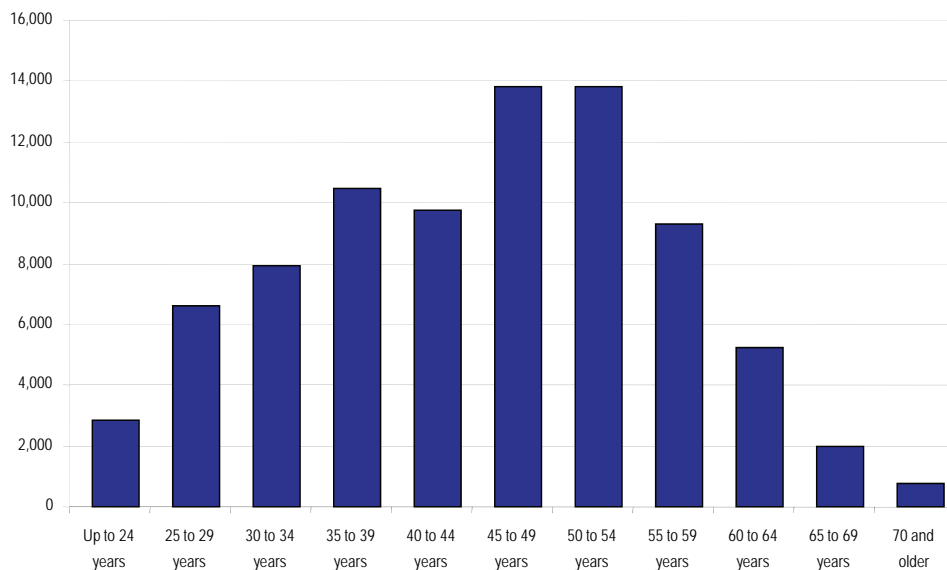

Please note that some registered nurses in older age ranges are thought to have retained registration for sentimental reasons and are probably not working.⁵³

- 8.44 This problem is Australia-wide. In 2005, the Australian Institute of Health & Welfare took a census on the demographic and employment characteristics of nurses and midwives in Australia.⁵⁴ The data indicated that, from 2001 to 2005:
- the average age of employed nurses in Australia increased from 42.2 years to 45.1 years;⁵⁵ and
 - the proportion of nurses aged 50 years and over increased from 24.4% to 35.8%.⁵⁶
- 8.45 In 2006, a survey of the NSW nursing workforce by NSW Health indicated that approximately 22% of registered nurses working in NSW were 55 or older.⁵⁷ Studies suggest that few registered nurses continue in the workforce beyond 60 years of age.⁵⁸

This means that, within 3 years, almost ¼ of the nursing workforce will probably need to be replaced, one way or another.

- 8.46 A clinical nurse consultant at Royal North Shore Hospital made the following observations about the implications of these statistics:

"The average age of a nurse in 2005 is 45, and 35 per cent of our workforce is 50 years or older. If we don't start doing something to encourage more nurses to enter the profession and stay in the profession, I think we will be in a lot of trouble in five to ten years with 35 per cent of the workforce probably retiring in that period."⁵⁹

- 8.47 More recent data obtained from NSW Health (in the table below) suggests that the proportion of younger nurses is gradually increasing as a proportion of the workforce, but there is still a long way to go before the ageing workforce is sustainably rejuvenated.⁶⁰

Table 8.2 Age of registered and enrolled nurses in NSW (2006 and March 2008)

Age group	2006 (%) (public and private)	March 2008 (%) (public only)
20-29	8.6	16.5
30-44	33.7	37.9
45 and above	57.2	45.7
Total	100	100

- 8.48 The statistical evidence as to the ageing nursing workforce was confirmed anecdotally during the Inquiry.
- The Director of Nursing at Gosford Hospital informed me that the average age of registered nurses on the Central Coast is 45 to 47 years of age.⁶¹
 - The Acting Divisional Manager for Women's, Children's and Family Health at Gosford told of difficulties recruiting midwives due, in part, to an ageing workforce.⁶²
 - I was told that at Goulburn the nurses are ageing, and there are not many young, recently-graduated nurses coming through Goulburn Hospital.⁶³
- 8.49 I was told that the mental health nursing workforce is also ageing.⁶⁴ To deal with this problem, NSW Health has provided a number of scholarships to enable enrolled nurses to become registered nurses with mental health skills. I was told that this initiative has been quite successful.⁶⁵

Do we have enough nurses?

- 8.50 In June 2008, there were 40,612 nurses employed in NSW public hospitals.⁶⁶
- 8.51 Australia ranks well against other OECD nations in terms of the number of nurses per 1,000 population (see graph below), the ratio of nurses to doctors, and the level of remuneration.⁶⁷

Nursing Concentrations: Australia v OECD

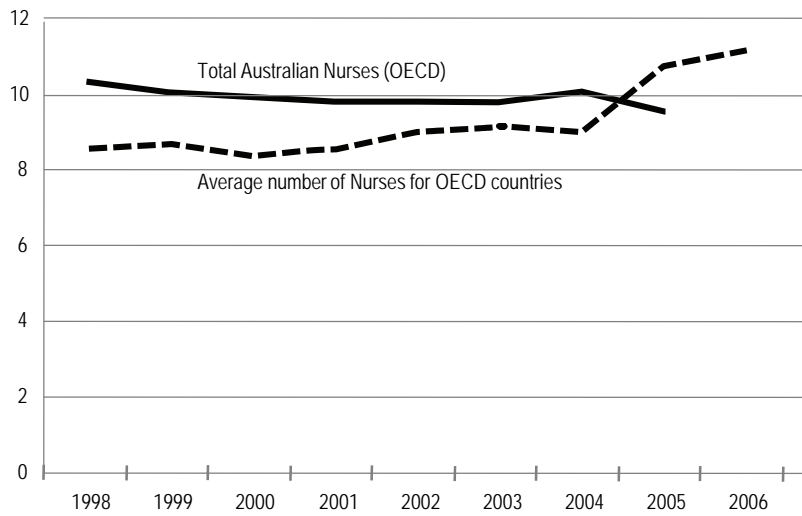

8.52 However, compared to other OECD countries, Australia is well below the OECD average in terms of the number of nursing graduates per 1,000 nurses.⁶⁸ This statistic is a measure of the rate at which new nurses are being trained to replace existing nurses. This would tend to suggest that Australia is not training enough nurses to redress the problem of the ageing population referred to above.

8.53 Projection modelling for nursing is undertaken annually by NSW Health to assess required intakes for university commencements.⁶⁹ An analysis in 2007 of labour force registration survey data indicated that 1,769 additional university places were required to commence in 2008 for registered nurses in order to balance the workforce requirement by 2014.⁷⁰ A total of only 416 places were allocated by the Commonwealth Government against this requirement.⁷¹

8.54 The following graph shows the supply and anticipated supply of nursing graduates for the period 1990 to 2010.⁷²

Nursing graduations 1990–2005 and projected workforce entrants 2006–2010

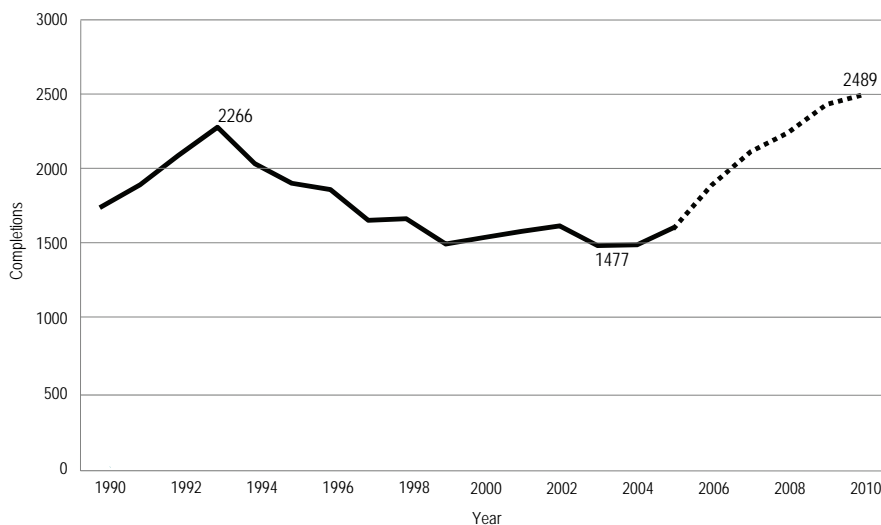

Source: Department of Education Workplace Relations, NSW Health

8.55 Whilst there has been a consistent push to increase university places for nursing, there are high capital costs involved, which I am told makes the universities slow to do so.⁷³

- 8.56 Agency nurses, casual staff and overtime supplement the lack of graduate supply.⁷⁴ Enrolled nurse training numbers have also been increased over time.⁷⁵
- 8.57 NSW Health told the Inquiry that nursing shortages nationally are currently projected to be between 10,000 and 12,000 for 2010.⁷⁶
- 8.58 On any view of these numbers, there is looming for NSW Health a major crisis arising from such a significant shortage in the nursing workforce.
- 8.59 The NSW Nurses' Association informed me that there are approximately 10,000 nurses in NSW who could potentially return to the public health system, and that this reservoir of people may be the potential saviour of the NSW health system.⁷⁷

Efforts to recruit more nurses

- 8.60 As at 4 April 2008, NSW Health was actively recruiting 1,089 nursing positions. Most vacancies were in the areas of generalist nursing and midwifery, medical, surgical, mental health, emergency and intensive care.⁷⁸
- 8.61 The following table sets out the number of full-time equivalent nursing positions that were actively being recruited by each area health service as at 18 July 2008.⁷⁹

Table 8.3 Full time equivalent positions actively being recruited by area health services (18 July 2008)

Area health service	
- Children's Hospital at Westmead	28.9
Justice Health	11.3
Sydney South West	183.4
South Eastern Sydney / Illawarra	217.2
Sydney West	115.6
Northern Sydney / Central Coast	161.4
Metropolitan total	717.8
Hunter / New England	137.3
North Coast	114.7
Greater Southern	132.8
Greater Western	145.7
Rural total	530.5
State total	1,248.3

- 8.62 I was informed that in 2008, there were more newly-graduated registered nurses than positions in NSW Health.⁸⁰ However, some positions were not filled, as the graduates did not wish to go to certain places.⁸¹ Active recruiting is still required for positions in rural areas.⁸² I was told:

"The positions are not where the graduates want to go. They don't want to go to Brewarrina, they don't want to go to Bourke. They will wait. They said to us, 'I will wait until there is a position next to where I live'."⁸³

Reconnect program

- 8.63 NSW Health's "Reconnect" program aims to bring nurses and midwives who are currently not working back into the workforce.⁸⁴ The program provides funding to the area health services to support the re-orientation of these nurses into the current way of practice.⁸⁵
- 8.64 Through this program, 1,710 nurses have returned to NSW Health since 2002.⁸⁶ Of those nurses, NSW Health has retained approximately 77%.⁸⁷
- 8.65 The program is well received, according to evidence which I heard. For example, I was told that Mudgee Hospital has gained 5 nurses as a result of the Reconnect program.⁸⁸
- 8.66 In addition, NSW Health has specifically targeted a Reconnect program for the mental health area: "Mental Health Nurse Connect".⁸⁹ 127 nurses have been employed under that program since April 2005.⁹⁰ The program provides scholarships to support nurses to upgrade their skills or to obtain specialist qualifications, and to enable enrolled nurses to become registered nurses.⁹¹

"Bringing Nurses Back to Work"

- 8.67 The Commonwealth recently announced the "Bringing Nurses Back to Work" program, which will complement NSW Health's Reconnect program.⁹² Under the Commonwealth program, a \$6,000 bonus will be paid to nurses who return full time to the workforce.⁹³

Recruit & Retain programme

- 8.68 I have discussed this programme in Chapter 6.

Overseas nurses

- 8.69 NSW Health recruits experienced overseas nurses.⁹⁴ This is a lengthy and complex procedure and it can take 9 months from initial application until the nurse arrives.⁹⁵ During NSW Health's most recent overseas campaign, 200 nurses were interviewed, of whom 100 accepted job offers.⁹⁶
- 8.70 I was told that NSW Health has an ethical code about not taking nurses and medical practitioners from third world countries.⁹⁷ In this regard, NSW Health uses the *Code of Practice for the International Recruitment of Health Workers*⁹⁸ to guide the recruitment of clinicians from third-world countries.⁹⁹ The Code of Practice is intended to discourage the targeted recruitment of health workers from countries which are themselves experiencing shortages.¹⁰⁰
- 8.71 A number of area health services also recruiting internationally.¹⁰¹
- 8.72 As nurses from Wagga Wagga Base Hospital (which has a number of overseas nurses) told me, overseas nurses upon arrival in Australia need support, education and guidance to help them adapt to the Australian culture and the high standard of health care delivered here.¹⁰² I agree. Clearly, if overseas recruitment is to be pursued, and there is to be a significant influx of nurses, then support and induction procedures need to be established to deal with any cultural issues that may arise, both in terms of workplace culture and broader country-of-origin issues. Particular provision may also need to be made for their training and supervision (at least initially) in the workplace. I have already discussed this in Chapter 7 in respect of overseas doctors, and my comments and recommendation are applicable to overseas nurses.

Recommendation 22: *NSW Health should review the current induction program which is undertaken for overseas trained nurses prior to them commencing employment in the NSW public hospital system, and enhance it so as to make more efficient and effective the employment of overseas trained nurses.*

Administrative over-burdening of Nurse Unit Managers

- 8.73 The most frequently mentioned problem in the Inquiry was the administrative burden that has been imposed on nurse unit managers since the reduction in support staff in hospitals in about 2003. NSW Health also appeared to me to regard this issue as genuine and incontestable.¹⁰³ In its submission to the Inquiry, NSW Health told me that it had commissioned a review of processes and approvals for recruitment and purchasing at 6 hospitals - the *Cutting Red Tape* Review - and that the review's Draft Report acknowledged that the provision of appropriate clinical support is a core issue for clinical managers.¹⁰⁴

Roles and remuneration

- 8.74 The position descriptions for nurse unit managers are presently developed at the area health service or organisation level (although position descriptions are being developed by the "Take the Lead" project, which I discuss elsewhere).¹⁰⁵
- 8.75 There are 3 levels of nurse unit managers in NSW Health.¹⁰⁶ The responsibilities of a nurse unit manager Level 1 include:
- (a) coordination of patient services;
 - (b) unit management, including:
 - (i) implementation of hospital / health service policy,
 - (ii) monitoring the use and maintenance of equipment,
 - (iii) monitoring the supply and use of stock and supplies,
 - (iv) monitoring cleaning services; and
 - (c) nursing staff management, including
 - (i) performance appraisals,
 - (ii) rostering and
 - (iii) the development and/or implementation of new nursing practice according to patient need.¹⁰⁷
- 8.76 Nurse unit managers Levels 2 and 3 have progressively greater responsibilities in the above areas than nurse unit managers Level 1.¹⁰⁸

8.77 The following table sets out the salary rates for nurse unit managers Levels 1-3.¹⁰⁹

Table 8.4 Salary rates for Nurse Unit Managers / Midwifery Unit Managers

	Per week	Per annum	Plus super (9%)	Total
Level 1	\$1,606.50	\$83,824.90	\$7,544.24	\$91,369
Level 2	\$1,682.80	\$87,806.10	\$7,902.55	\$95,709
Level 3	\$1,728.10	\$90,169.80	\$8,115.28	\$98,285

Tasks undertaken by Nurse Unit Managers

8.78 According to the evidence I received, nurse unit managers spend a great deal of their time on the following administrative tasks:

- (a) budget control, which I was told can be very complex;¹¹⁰
- (b) payroll, which I have considered in more detail below;
- (c) human resource management and recruitment, which I have considered in more detail below;
- (d) rostering;
- (e) liaising with Stores, including placing orders for non-standard items,¹¹¹ and chasing up orders;¹¹²
- (f) procuring equipment that is not supplied by Stores;
- (g) chasing up test results;
- (h) Occupational Health & Safety, including ensuring that there are safe work practices for all equipment and procedures and performing risk assessments,¹¹³
- (i) compiling reports;
- (j) discharge planning and bed flow management;
- (k) Incident Information Management System management – see Chapter 16;
- (l) data collection for monthly reports such as documentation audits, drug audits, workforce reports, budget, armband audits, and environmental inspection audits (I was told that since the amalgamation of the area health services the demands for short-term reporting have rendered the nurse unit manager position nearly untenable);¹¹⁴
- (m) performance management;¹¹⁵ and
- (n) complaints management.¹¹⁶

8.79 Nurse unit managers across NSW have complained to me about the large amount of time they spend on administrative work, which takes them away from managing the care of patients and being clinical leaders. Estimates by nurse unit managers of the time spent on such tasks ranged from 40% to 100% but were, on average, about 70%.

- At Concord Hospital, I was told that administration comprises 50-60% of the nurse unit managers' daily work.¹¹⁷ This includes signing off on payroll, overseeing rostering and chasing up diagnostics.¹¹⁸

- At the Emergency Department at Royal Prince Alfred Hospital, the nurse unit manager spends 40% to 60% of her time on administrative work – preparing rosters, wage sheets and other paperwork – rather than “hands on” caring for patients.¹¹⁹
- A nurse unit manager at Liverpool informed me that she spends half of her working day on the phone for rostering reasons, “begging people to come in for night shift”.¹²⁰
- A nurse at Tamworth Base Hospital gave evidence that nurse unit managers spend between 50% and on some days 100% of their time attending to management tasks, and do not have sufficient time to attend to the education of their staff.¹²¹
- The Director of Nursing at Coffs Harbour Base Hospital told me that the nurse unit managers on the 48-bed wards at the hospital spend about 80% of their time on staff support tasks, human resources and management, rather than on direct clinical duties or direct clinical support of people undertaking clinical duties.¹²²
- A nurse unit manager at Hornsby Hospital told me that she spends approximately 50% of her time on administrative work, which could be undertaken by a non-nursing clerical worker.¹²³ Another nurse unit manager at Hornsby Hospital said that the non-clinical responsibilities of nurse unit managers are continually growing, and those responsibilities have to be left to quiet periods when nurse unit managers can safely forgo clinical work.¹²⁴ This means that the administrative work piles up.¹²⁵ She also told me that nurse unit managers have had to take up many additional responsibilities over time, such as human resources and OH&S management, because human resources support has deteriorated.¹²⁶
- A nurse unit manager at Royal North Shore Hospital informed me that she conducted a time and motion study on another nurse unit manager, which demonstrated that 60-70% of the nurse unit manager’s time was absorbed in discharge management and patient flow.¹²⁷
- Nurses at Bankstown Hospital were concerned that nurse unit managers are tied up with additional duties including staffing, pay, stores issues and human resources.¹²⁸ This limits their ability to attend to clinical matters to ensure patient flow.¹²⁹ One nurse unit manager at that hospital told me that 70% of her day is spent in the office, away from clinical situations.¹³⁰ She also told me that most of the administrative work done by nurse unit managers could definitely be done by someone other than a nurse.¹³¹ Such duties include filling out maternity leave paperwork, ringing the pay office, and ordering consumables.¹³²
- A witness at Tweed Heads told me that because of the lack of administrative staff, senior clinical staff and nurse unit managers are undertaking payroll duties.¹³³
- During my visit to Corowa Hospital, I was told that the nurse unit managers of the Acute Ward and Emergency Department spend much of their days undertaking administration, including coping with the payroll system, Ezi Suite and other software programs.¹³⁴ As both of these nurse unit managers hold a clinical role each day, the additional administrative work imposed upon them by administrative staff cuts creates difficulties.¹³⁵ They said that would be much assisted by the appointment of an administrative assistant.¹³⁶
- Another nurse unit manager informed me that her workload is enormous, involving the following tasks:

“We have E-recruit, HR management, internal and external stock ordering, IIMS management and expected date of discharge management. They are all activities, plus many more, which impinge on the daily running of the ward to ensure staff had adequate clinical supervision, whether direct or indirect.”¹³⁷

- A rehabilitation physician made the following observations on the large amount of time that nurse unit managers spend on administrative tasks, and the potential consequences:

"[T]o me it appears they spend more than 50 per cent of their day chasing around trying to find nursing staff to cover shifts, doing the roster, finding people to backfill people who are sick. When there is no-one around to do it, it takes up an inordinate amount of time which I think is a real shame. That person should be the clinical person who has the oversight of all the patients, what is happening, where they are going and if that person was effective, I think there would be a lot less mistakes happening, as a systemic issue."¹³⁸

- A nurse unit manager at The Tweed Hospital informed me that finding equipment takes up a lot of nurse unit managers' time.¹³⁹ She stated that on the day of her evidence she had spent 1½ hours trying to track down new wheelchairs to replace others that had been condemned.¹⁴⁰ There was no centralised area that she could call, and she was thus required to find the supplier and get quotes.¹⁴¹
- A nurse manager at Nepean Hospital told me that nursing unit managers are frequently "tearing their hair out" with delays in the system (including ordering stores, recruiting staff and getting people on the payroll).¹⁴²

"These are] basic things that you shouldn't have to worry about, and that is how you waste your day."¹⁴³

8.80 She noted that the time of nurse managers and nurse unit managers could be better spent doing other tasks, rather than chasing up routine things that should happen normally.¹⁴⁴

8.81 It is clear that many of the nurse unit manager's tasks now involve working with data systems introduced for payroll, rosters and the like, but the numbers of administrative support staff employed by the Health Support Unit have been considerably reduced, with the consequence that nurse unit managers complained that it was very difficult to contact anyone for assistance. I have discussed this problem further in Chapter 32.

Payroll

8.82 Nurse unit managers enter raw data for payroll purposes, although do not calculate pay or generate payslips.¹⁴⁵ A nurse unit manager's responsibilities in relation to payroll typically include preparing documentation and entering data in respect of:¹⁴⁶

- leave classifications, such as maternity leave;
- call-back and overtime information related to payroll, including payroll breakdowns;
- coding of travel allowances for each call-back;
- coding appropriate allowances for meal breaks, depending upon whether overtime or call-back applies;
- coding annual leave for part-time staff using appropriate rates, requiring knowledge of their average hours for the previous 6 months; and
- acting as "go-between" for staff and the pay office in relation to information concerning entitlements and leave allowances.

8.83 As well, enquiries by ward staff in relation to payroll are directed to the nurse unit manager, including the need for adjustments and incorrect recording of leave.¹⁴⁷ I was told that nurse unit managers are required to contact Payroll Services to sort out problems on a 1800 number that is often not answered, and with phone calls sometimes

not returned.¹⁴⁸ Nurse unit managers are not trained in the quite complex health service union awards, which sometimes results in staff not being paid correctly.¹⁴⁹

8.84 A nurse at Byron Bay District Hospital told me that the PROACT rostering system is particularly onerous and time-consuming: nurse unit managers have to make many daily time-consuming adjustments to PROACT to ensure staff are paid correctly.¹⁵⁰ Previously, the pay officer undertook the bulk of this work.¹⁵¹

8.85 Another nurse made the following complaints in relation to the demands of PROACT:

"To be able to meet the demands of PROACT, I have to give up the time I used to be able to allocate for me to run therapeutic groups with my patients. Occasionally, when public holidays are involved and an edict comes from payroll to have to sign off completed by a certain date, it necessitates me to come in on my day off."¹⁵²

Recruitment

8.86 NSW Health's Policy Directive 2008/045 - *Recruitment of Nurses and Midwives: Framework* - states that nurse unit managers should not be involved in the clerical aspects of recruitment except for certain parts of the interview process.¹⁵³ According to NSW Health, the following table sets out the phases of the recruitment process performed by human resources and nurse unit managers, in accordance with PD2008/045.¹⁵⁴

Table 8.5 Recruitment functions performed by Human Resources, Nurse Unit Managers or Midwifery Unit Managers

Recruitment and Selection process	Performed by
Review position documentation/selection criteria/need to fill	Nurse unit manager
Review eligibility lists	Nurse unit manager / Human Resources
Review available redeployees	Human Resources
Prepare the advertisement for the position	Nurse unit manager
Advertise the position	Human Resources
Provide contact person for applicants	Nurse unit manager
Provide further information to applicants	Nurse unit manager / Human Resources
Collate applications	Human Resources
Convene selection committee (including organising the committee, arranging the interview room etc)	Nurse unit manager
Cull applications	Nurse unit manager
Arrange selection interviews	Nurse unit manager
Conduct selection interviews and review applicants' relative merit	Nurse unit manager
Conduct referee checks	Nurse unit manager
Prepare selection report/recommendation for appointment/eligibility list	Nurse unit manager
100 point ID check and collection of authority to conduct checks	Nurse unit manager
Conduct pre employment checks	Human Resources
Prepare the letter of offer/make the job offer	Human Resources
Post selection documentation	Human Resources

- 8.87 The evidence given to me shows quite clearly that despite PD2008/045, nurse unit managers are very heavily engaged in recruitment-related clerical tasks. I have been told that nurse unit managers now have to complete almost the entire recruitment process with minimal centralised administrative support.¹⁵⁵ As I noted earlier, nurse unit managers are required to prepare advertisements for vacant positions, and undertake reference checks.¹⁵⁶ I was told that nurse unit managers also undertake a great deal of other clerical work relating to recruitment – from accepting the recruitment packages, writing letters of acceptance, writing letters to arrange interviews, arranging for the interview panel to be convened and supplied with the relevant paperwork and conducting the interview, to auditing the recruitment file before it is sent back to human resources.¹⁵⁷ They reportedly do this with little administrative support from human resources.¹⁵⁸ Nurse unit managers also have to take identification photos of new staff, and complete a complicated process to obtain identification tags.¹⁵⁹
- 8.88 On one view, its not inappropriate that nurse unit managers have some involvement in the recruitment of staff to their wards: they are best placed to know the skills and level of experience required for particular nursing positions. The real issue seems to be the provision of support for the administrative duties that are generic to recruitment, do not require the professional training and background, or expertise of a senior clinician such as a nurse unit manager and can properly be delegated to a person of different expertise whose time will be far less costly than that of the nurse unit manager.
- 8.89 I have described in Chapter 32 the increasing support being rolled out across NSW in respect of the recruitment process, and expect that it will alleviate some of the burdens presently placed on nurse unit managers in this regard.

Loss of clinical role

- 8.90 One nurse unit manager informed me that the development of projects to improve the clinical unit now has to be done by nurse unit managers in their own time.¹⁶⁰ Another nurse unit manager said that because nurse unit managers are “wedded” to their computers for most of the day, there is limited or no time to mentor and supervise staff or to arrange and provide staff education.¹⁶¹ As mentioned above, nurses at Bankstown Hospital told me that because nurse unit managers are tied up with additional duties – such as staffing, pay, stores and human resources – their ability to attend to clinical matters to ensure patient flow is limited.¹⁶²
- 8.91 The Nurse Manager of the Emergency Department at Sydney Children’s Hospital made the following comments in relation to the loss of the clinical aspect of her role:

“Increasingly, in the eight years I’ve been a nurse manager, there has been reduced capacity for me to be a clinical or a strategic leader as I increasingly take on board administrative responsibilities. Increasingly, I am responsible for procurement of resources and, as maintenance services across the hospital are reduced, I’m expected to access those kind of services as well.

More importantly, when you look at the risk that has been identified across the State with respect to events like what happened at North Shore, some of the things that were identified are education and training and the accessibility of good management. As I increasingly spend my time looking at a computer, as I do more and more administrative work, I’m less and less able to provide the leadership that I want to, that I believe gives your workforce strategic direction, wants them to stay, gives them a chance to be effectively trained so that they can do the work they need to do.”¹⁶³

- 8.92 The lack of available clinical time for nurse unit managers adversely impacts upon patient care.¹⁶⁴ One doctor described the current role of nurse unit managers as a “huge loss to the ward environment”, and pointed out that getting nurse unit managers back on the ward would save a lot of time for other nurses.¹⁶⁵

Solutions

- 8.93 Nurse unit managers generally agreed that they would be much assisted by an assistant.
- One nurse said that to have some administrative support in the form of a person who could just answer her phone would make it much easier for her to have the critical and difficult conversations involved in nurses’ annual appraisals:

“What would help enormously is to have someone to assist in the procurement of those resources, or the signing on of that nurse, ... to make it possible for me to do the things I believe we need to do to keep our workforce strong and robust and satisfied.”¹⁶⁶
 - During my visit to Corowa Hospital, I was informed by the nurse unit managers of both the Acute Ward and Emergency Department that their work would be greatly helped by the appointment of a clinical assistant.¹⁶⁷
 - Staff at Hornsby Hospital also told me that the presence of support officers in the Emergency Department would assist in relieving nurse unit managers and clinicians from mundane, time-consuming clerical work.¹⁶⁸
 - One nurse thought that most of the administrative work done by nurse unit managers could definitely be done by someone other than a nurse.¹⁶⁹ In this context, she pointed to a number of tasks including the execution of maternity leave paperwork, phone calls to the pay office and the ordering of consumables.¹⁷⁰
 - Another nurse made the following comments about the types of duties that could be delegated to such a clinical assistant:

“Ideally you would have a nurse do it because of the background that they have, but if you have a particular role like that, you can teach someone to do those sorts of jobs. They need to know exactly what it is that they have to do within that role. For example, with the ordering, they need to have a very good orientation to that ordering and what is required and what is needed and good communication between the leaders within that area. If they have that, then I think that could work. With rostering, you can have someone do those sorts of jobs. They have to learn who is who, what’s what, who is the most senior - those sorts of things. It is not necessarily the nurses who can do that. I think other people could do that. They have to be made aware of what is required to do that and the nuisances of those certain systems, so I do believe that a non-nurse person can do that as long as they are properly trained.”¹⁷¹
 - The Director of Nursing at Gosford Hospital informed me that in her view, many aspects of nurse unit managers’ role could be done by somebody other than the nurse unit manager – for instance, payroll and validation of rostering.¹⁷²
 - A very experienced nurse unit manager at Dubbo Base Hospital said that as the nurse unit manager role has changed - with more “paperwork” expectations for standards and hazard reports - clerical support, including somebody who has expertise in typing and computers, is required.¹⁷³

- A nurse unit manager at Wollongong Hospital was of the view that responsibility for the budget should remain with the nurse unit manager or a nurse.¹⁷⁴ She told me that in her view, nurse unit managers should be responsible for rostering, although someone else could enter that roster into the KRONOS system.¹⁷⁵ She said that this would free up a typical shift by 20%.¹⁷⁶ Another nurse unit manager at Wollongong Hospital said that this would also allow nurse unit managers to attend doctors' rounds, making them more aware of patients' needs.¹⁷⁷
- 8.94 The solution suggested by one of the nurse unit managers at Wollongong Hospital was to have more clinical educators, or a "patient flow nurse", to alleviate some of the nurse unit manager's responsibilities.¹⁷⁸ A patient flow nurse would coordinate discharges and admissions to the unit, and facilitate smooth progress through the patient's admission.¹⁷⁹ Part of the role would be to make sure the diagnostics are done in a timely fashion, and to coordinate x-rays.¹⁸⁰
- 8.95 Other nurses agreed that, in preference to an assistant, a clinical nurse educator or clinical nurse consultant and a clinical co-ordinator was the answer. For instance, a nurse unit manager at Port Macquarie Base Hospital made the following statements:
- "My solution for those particular issues ... was that I need clinical educators or CNCs, they would be an answer, and/or clinical coordinator on my ward. This has been discussed with my manager and a brief was sent to the area regarding a clinical nurse educator, but it was rejected. I would also as well like an evening ward clerk, because the ward becomes extremely busy on an evening and for my staff to work effectively they are constantly trying to manage calls as well."¹⁸¹
- 8.96 Another nurse stated what seems to me to be quite common sense:
- "To me it does not make sound economic sense to utilise highly experienced, highly skilled and reasonably well paid nurses and midwives to do administrative duties more suited to clerical staff. These nurses and midwives are of more value in ensuring the safe and effective delivery of care on the unit that they manage."¹⁸²
- 8.97 One doctor made the following observations in relation to the loss of nurse unit managers' clinical role, and the solutions that might be implemented to address this:
- "You need the nurse unit manager as the clinical leader of the ward. [He or she] still needs to have a managerial role. She needs to be available for most of [the] working day to do clinical work, but [he or she] needs someone in the office doing the pure clerical administrative tasks that tie [him or her] down to her office which are largely things to do with rostering Kronos, the typing out or reviewing of umpteen dozen emails and bits of nonsense that come through. But [he or she] needs a clinical or a clerical assistant."¹⁸³
- 8.98 The work of an assistant to the nurse unit manager would be clearly relevant to clinical tasks being undertaken on the ward, bearing on the ultimate safety and quality of care of patients. Consequently, the title for such an assistant should be "clinical assistant".
- 8.99 There is no doubt that the nurse unit manager would have to supervise the assistant's performance of some tasks, for example:
- (a) Specifying the skill mix required for a particular shift, with the assistant finding nurses for that particular shift accordingly;¹⁸⁴

- (b) Ordering stocks: a clinical background is needed to know which wounds require what dressing, and which patients need air mattresses to prevent ulcers;¹⁸⁵
- (c) Ordering drugs: a clinical background is also required to know the drugs that are likely to be used and order those in advance.¹⁸⁶

8.100 There may be differing views on what tasks require a nurse unit manager's input, but no doubt this could be ascertained with some focussed discussion in each unit because flexibility will be the key to the role.

"Take the Lead"

8.101 Some work in this area has already been undertaken by NSW Health.

8.102 The "Take the Lead" project is examining the role of nurse unit managers at the unit level, and was initiated in response to patient feedback and anecdotal information from nurse unit managers.¹⁸⁷ Since early 2007, 4 key activities have been adopted as part of the project, with a view to exploring what is happening for nurse unit managers across NSW.¹⁸⁸ Those activities involve workshops, a questionnaire, a forum and interviews.¹⁸⁹ I understand that as part of the project NSW Health has engaged with and/or spoken to around 49% of the total nurse unit manager population of NSW.¹⁹⁰

8.103 In broad terms, the significant findings that have arisen from the study are:

- There is an extensive depth and breadth in the accountability, responsibility and functions that nurse unit managers currently perform.¹⁹¹
- There is a lack of clarity and inconsistencies in and around how nurse unit managers perform their roles across NSW.¹⁹²
- More than 60% of the activities performed by nurse unit managers involve transactional, managerial and administrative tasks.¹⁹³ Those activities take nurse unit managers away from a "connectedness" to patient care.¹⁹⁴
- 64% of nurse unit managers' time is taken up with general management tasks, whilst patient care activities take about 16% of nurse unit managers' time.¹⁹⁵
- Of the general management tasks, staffing and human resources management (managing leave, counselling, and rostering) take up a significant amount of nurse unit managers' time.¹⁹⁶

8.104 On 2 September 2008, I was told that the project would shortly look at developing strategies to work collaboratively across the state in order to address transactional and administrative tasks undertaken by nurse unit managers.¹⁹⁷ This involves re-organising the way work is done by nurse unit managers.¹⁹⁸ I understand that clinical duties of nurse unit managers include intensive care of patients, ward rounds, supervision and mentoring of junior staff, and monitoring of infection controls.

8.105 Under the project, NSW Health does not propose to prescribe a standard nurse unit manager position description.¹⁹⁹ I was told that because of the variable clinical context in which people work, to do so would be very problematic.²⁰⁰ Rather, the project hopes to develop a conceptual framework that articulates the purpose and the core functions of the nurse unit manager role.²⁰¹ In this context, a representative of NSW Health made the following statements:

"That foundation should ... be able to fit no matter whether you work in mental health, in ICU at Royal North Shore or at Broken Hill in a multipurpose unit. Fundamentally, your purpose and your core functions should still be the same and your position description

should then fit on top of that. That is unique to the context in which you work.”²⁰²

- 8.106 The evidence demonstrates that the safety and quality of patient care improves when senior nurses are freed up to attend directly to patients and to the mentoring of junior nursing staff and to the monitoring of junior staff, both doctors and nurses. The freeing of nurse unit managers from the burden of administration is not to be at the expense of simply shifting the burden to less senior nurses. These tasks are to be performed by the introduction of additional clinical assistants and existing clerical staff. Otherwise the whole point, which is to bring about a dramatic improvement in the quality of care and the safety of treatment, will be lost.

Recommendation 23: *NSW Health should, as a matter of priority, review and redesign the role of the nurse unit manager (“NUM”) so as to enable the NUM to undertake clinical leadership in the supervision of patients and the enforcement of appropriate standards of safety and quality in treatment and care of patients in the unit or ward for which they are responsible. This redesign needs to encompass either the transfer of a range of duties from the NUM to other existing staff members or alternatively the creation of a role of clinical assistant to the NUM to undertake those tasks. . The aim of the redesign is to ensure that at least 70% of the NUM’s time is applied to clinical duties and no more than 30% of the time is applied to administration, management and transactional duties.*

Recommendation 24: *All hospitals employing nurse unit managers report within 6 months to the Chief Nurse of NSW Health how they will re-allocate the duties currently being undertaken by the NUM in line with my earlier recommendation and all hospitals employing NUMs should complete the implementation of the redesigned role within 2 years.*

Remuneration

- 8.107 A significant concern raised by nurses during the Inquiry was the low remuneration they receive. I was told that NSW Health is constrained to offer no more than 2.5% wage increases per annum under *Public Sector Wages Policy 2007*.²⁰³ Anything above 2.5% has to be offset against employee-related efficiencies.²⁰⁴
- 8.108 For a registered nurse who wishes to remain in clinical practice (rather than management) to earn more after 8 years, he or she needs to enter a clinical stream or an education stream.²⁰⁵
- 8.109 Certainly, low pay appears to make it difficult for hospitals to retain experienced registered nurses.
- During my visit to Concord Hospital, nurses told me that they would like to see more senior emergency nurses stay at the hospital, but the year 8 pay threshold was a problem.²⁰⁶ Nurses at that hospital also informed me that they need more of a career path.²⁰⁷
 - A midwife at the Blue Mountains Hospital said that if we want to keep nurses in the system, rewards need to be provided to the ones who have “hung in there”.²⁰⁸ She suggested that after the first 10 years of service, a bonus or some monetary incentive could be provided.²⁰⁹

- One doctor made the following comments in relation to the fact that senior nursing staff are no longer rewarded for looking after patients “by the bedside”:

“In nursing, the other issue apart from nights is the clinical versus non-clinical awards. Their structure rewards them for moving out of clinical work into management or into administration so when you combine that with the unattractiveness of nights, there is a flow-out of clinical nursing.”²¹⁰
 - Similarly, a doctor observed that while supervisory and administrative positions represent a significant promotional opportunity for nurses, it also removes the best nurses from the clinical interface.²¹¹
- 8.110 Some hospital managers are coming up with different ways to reward long-serving nurses. For instance, the Health Service Manager at Bourke Health Service told me that a nurse manager who had stayed in the area for a very lengthy time had extra time added onto her long service leave.²¹²
- 8.111 The Director of Nursing at Gosford Hospital suggested that increasing nurses’ pay would not solve the problem, as more nurses would convert to part-time work, or reduce their part-time hours further.²¹³ (I note that 41% of the nursing workforce in NSW Health work part-time.)²¹⁴ She told me that in her view, the nursing vacancy rate is exaggerated by the fact that more nurses are reducing their hours of work:

“They are doing that because of a lifestyle choice, but also because of the untenable workload that nurses find themselves working in.”²¹⁵
- 8.112 A nurse who works at the John Hunter Hospital told me that the lack of nursing staff across NSW is not a function of pay, but rather a general lack of conditions for nursing staff.²¹⁶ In this context, he stated:

“Pay when I started was absolutely miniscule. It was about \$12 or \$14 per week. That is nowhere near what we are doing now. I don’t think it is the pay scale that is deterring the people from becoming nurses. It is actually the conditions that are applied.”²¹⁷
- 8.113 Experienced clinical nurses who are willing to remain focussed on delivering patient care, as opposed to moving into administration or other non-clinical tasks, are a vital resource in the NSW health system. These nurses must be encouraged, motivated, nurtured and developed. It seems to me that the current award structure may not do this, with the result that this vital resource is not encouraged, but rather may be being unnecessarily discouraged.
- 8.114 There needs to be a career path for senior clinical nurses so that they can stay ‘by the bedside’ without any financial disadvantage. It seems to me that if an improved career path is available, more experienced nurses will be on the wards, supervising and inspiring new nurses, and ensuring that patients receive safe, good quality nursing care in our hospitals.

Understaffing

- 8.115 One of the most common complaints which I heard during the Inquiry was that hospitals were understaffed with nurses. This complaint emanated from nurses, doctors, patients and patients’ families alike.

- For instance, Mr and Mrs Anderson expressed concern about the shortage of nurses in NSW public hospitals, and the fact that a junior nurse was left in charge of the entire ward during the night shift whilst Vanessa was at Royal North Shore Hospital.²¹⁸ They informed me that their observation of Royal North Shore Hospital at the time Vanessa was being treated there was that no nurse had any spare capacity.²¹⁹
- During my visit to the Oberon Multi-Purpose Service, I was told that the Emergency Department and the Acute Care ward are serviced during the morning and afternoon shifts by two registered nurses, an enrolled nurse and an assistant-in-nursing.²²⁰ Overnight there is one registered nurse and an enrolled nurse on duty.²²¹ The nurses regard themselves as being understaffed and with a very full workload.²²²
- A registered nurse informed me that it is difficult to get an increase in the number of bedside nurses at the Children's Hospital at Westmead, even though these are needed.²²³ She complained that money for increased nursing numbers is always directed to a new therapy or program, rather than the actual bedside.²²⁴
- I was informed by a nurse at Bankstown Hospital that when nursing is understaffed, there is rarely approval for overtime to cover the shortfall.²²⁵ Another witness at Bankstown Hospital informed me that the Emergency Department has approximately 15 less full-time equivalent positions than are required, although there are limited recruiting efforts within the area health service.²²⁶
- A registered nurse at Bathurst Hospital told me that she would like to see the staffing levels in the recovery ward addressed.²²⁷ This ward is a critical care area because patients are semi-conscious when they come out of the operating theatre.²²⁸ The facilities have gone from a 4 bay recovery ward in the old hospital with 2 registered nurses to an 8 bay first-stage ward with the same staffing levels.²²⁹ This witness told me that the standards of the Australian College of Operating Room Nurses stipulate that the correct and safe staffing/patient levels are 1:1 if the patient has an artificial airway device inserted, and 1:2 if the patient is alert, oriented and fully conscious.²³⁰ In this context, she said:

"The staff message is just not right, it's not happening, it's bordering on dangerous is what it is."²³¹
- A nurse from Wagga Wagga Base Hospital informed me that some staff who work in the theatre have accrued 13 to 14 weeks annual leave and have been told that they cannot take any annual leave for at least another 12 months.²³² However, their manager has taken annual leave.²³³
- In response to my enquiry as to how orthopaedic services at Gosford Hospital could be better organised within the present budget, a VMO made the following comments:

"I would probably employ a few less administrators and a few more nurses. I think part of the problem is that we are asking the nursing staff to do too much, look after too many patients, and that often is a delay. If a nurse has to look after six or eight patients, they can't prepare then for the operating theatre, whether that be in from the orthopaedic ward or from our day surgery units, there's delays there. I would increase nursing staff."²³⁴
- A Nurse Manager at Gosford Hospital told me that workload issues are very significant for nurses at the present time:

"I think it is very hard to keep people in a profession where they do look at it as a sweat shop, and it is very much like that on a daily basis."²³⁵

- 8.116 Understaffing was felt keenly in circumstances where nurses pointed to:
- (a) higher levels of patient acuity,
 - (b) shorter length of patient stay, and
 - (c) less senior, experienced nurses on shifts,
- as increasing the intensity of nursing work.
- 8.117 The NSW College of Nursing submitted that the ratio of experienced registered nurses to new graduates, trainee enrolled nurses and assistants-in-nursing has become a critical issue in many hospitals due to patient acuity and decreasing length of stay.²³⁶ This is compounded in wards where there are mixed specialties requiring different areas of expertise.²³⁷
- 8.118 The Acting Director of Nursing and Midwifery at Royal North Shore Hospital confirmed that there was a lack of senior nurses on the ward who, in the past, provided support to junior medical staff and education at the patient's bedside.²³⁸ She agreed that because the ward is "turning patients over" – admitting them, helping them and then discharging them quite quickly – the intensity of nursing work has increased.²³⁹
- 8.119 The Area Manager of the Northern Sydney Central Coast Area Health Service Acute Post Acute Care (APAC) Service told me that the acuity of patients using that service is increasing, and has done so over the last 12 years.²⁴⁰
- 8.120 A midwife at Wollongong Hospital told me that she sometimes finds herself in charge of the post-natal ward.²⁴¹ This witness also told me that when she is the only midwife on the ward, she is unable to take a meal break.²⁴² On some occasions she will have 22 women and their babies.²⁴³ She sometimes finds herself working with a registered nurse and a student midwife.²⁴⁴ She said that as well as being in charge of the ward, she is required to supervise student midwives.²⁴⁵ The witness told me that she needs at least one other midwife to be working with her, as there are a number of things that need to be attended to within maternity services that need to be checked by 2 midwives.²⁴⁶ She described these working conditions as "very unsafe".²⁴⁷
- 8.121 One nurse unit manager made the following comments in relation to the effect of understaffing on nurses:
- "As everybody knows there is a push for hospital beds now ... I see a quicker turnover of patients and far more acute patients. Then, I see a lack of ... nursing resources being available to manage more acute patients. A lack of skill mix; there seems to be less senior nurses. I see enrolled nurses and endorsed enrolled nurses being given a workload far beyond their capabilities of managing acute patients. I find that is not good for the nursing staff. I think that would probably result in a lot of nurses not staying, and also I see poor nursing care as a result of that, or probably not safe nursing care".²⁴⁸
- 8.122 Peri-operative nurses told me that staff workloads in the operating suites of NSW have increased incrementally over the last 20 years.²⁴⁹ Reasons for this were stated as including an ageing population requiring surgical interventions, an ageing workforce, fewer nurses entering and staying in the profession, new technologies, NSW Health policy directives, enhanced documentation requirements and increased demand for clinical teaching and support.²⁵⁰

- 8.123 A nurse at Armidale Hospital complained to me about inadequate skill mix and having an inappropriate level of staffing to cope with patient acuity.²⁵¹
- 8.124 It seems clear from the evidence I heard that understaffing of nurses is a widespread problem in NSW public hospitals.

Contributing factors

- 8.125 Understaffing arises in several ways.
- 8.126 Firstly, there may not be enough nursing positions allocated to a particular hospital, department or ward as are, in fact, needed, which may be attributed to problems with the Reasonable Workload Tool, which I have explained below.
- The Director of Nursing at Coffs Harbour Base Hospital told me that the budgets for nursing staff are not adequate to meet targeted activity and savings strategies are then put in place against these budgets.²⁵²
 - So too, a nurse unit manager stated that staffing levels in the operating theatres at Tamworth Base Hospital are below 2004 and 2006 standards: there are 3 staff per theatre (2 registered nurses and 1 enrolled nurse), whereas there should be 3.5 nurses per theatre.²⁵³
- 8.127 Second, and just as commonly, the correct number of nursing positions were allocated, but nurses of sufficient experience could not be found to fill these positions, or nurses were not attracted to work at that particular hospital.
- I was told that the Blue Mountains Hospital is funded for 13.8 full-time equivalent midwives but is running at 9.6, because that is all the staff they presently have.²⁵⁴ I was told by a nurse unit manager there that she and her colleagues were doing extra shifts and a lot of unpaid overtime as a result.²⁵⁵
 - A nurse unit manager at Royal Prince Alfred Hospital told me that there are not enough nurses in that hospital's ICU.²⁵⁶ He said that although the staffing numbers the hospital is permitted to have, have increased, finding the staff has been a problem – particularly staff with sufficient experience.²⁵⁷ He told me that about 47% of the nursing staff in the unit have less than 2 years experience.²⁵⁸
 - A clinical nurse specialist in the labour ward at Nepean Hospital told me that despite advertising for jobs in that unit, they could not attract people to western Sydney.²⁵⁹ She also said that the delivery suite needs a further position to be created to meet the increased workload.²⁶⁰
 - I was also informed that staffing at Coffs Harbour Base Hospital is a problem, there being 37 nursing vacancies as at 27 March 2008.²⁶¹
- 8.128 It seems to me that the third cause of understaffing is that nurses are being required to perform additional tasks, without allocating additional nurses to assist with those tasks.
- In this context, a nurse at Bankstown Hospital told me that directives from NSW Health and area health services increased nurses' workloads, but additional staff were not allocated to help nurses manage this.²⁶² She cited, as an example, the falls risk assessment/pressure area scale and a 6 page admission form, both of which increased the time that nurses spend on paperwork rather than on patient care.²⁶³
 - I was also told by a registered nurse at Mudgee Hospital that nursing staff have increasing responsibilities, but no extra time allocated to perform them.²⁶⁴ She stated:

"We have to do workplace assessments and compulsory education, and there's just a whole lot of new things we

have to do to maintain our standards, but there is no extra time allowed for that to happen. We are just feeling the increased pressures of all these added duties on top of everything that we already have. For those of us that are getting on a bit, it is just really too much pressure for us to be able to feel we can continue our job.²⁶⁵

- 8.129 Problems with “skill mix” are said to be a cause of understaffing. I will discuss these problems in Chapter 13.
- 8.130 The problem of understaffing is made worse as it appears common that when a nurse takes leave, a “replacement” nurse is not always employed during the period of leave. This appears to be designed to save money. A witness at Liverpool Hospital told me that some nurses are reluctant to take leave, as their positions are not back-filled and they know that when they return to work they are going to have to work twice as hard.²⁶⁶ This leads to burnout.²⁶⁷

Reasonable workloads

- 8.131 Since an industrial case in 2003 the concept of nurse “reasonable workloads” has been introduced, and there is now some degree of stringency about the number of nurses per patient bed day in NSW public hospitals.²⁶⁸
- 8.132 NSW Health’s obligation to provide reasonable workloads for nurses is articulated in clause 53 of the Award, which contains the General Workload Calculation Tool for general medical/surgical wards or units.²⁶⁹ The General Workload Calculation Tool allows each unit to predict how many staff need to be on a ward to ensure good patient care.²⁷⁰
- 8.133 The General Workload Calculation Tool takes into account a number of factors, including:
- value of the nursing weight – in applying the General Workload Calculation Tool, a nursing weight of one is equal to 4.8 nursing hours per patient day;
 - average nursing intensity;
 - occupancy rate;
 - available beds;
 - length of shift;
 - minimum staffing levels – use of the General Workload Calculation Tool does not displace minimum staffing requirements to ensure safe systems of work and patient safety;
 - coverage – the General Workload Calculation Tool is applied to calculate staffing levels for those nursing staff providing direct clinical care, and is not applied to positions such as nurse unit manager, clinical nurse educator, clinical nurse consultant, dedicated administrative support staff and ward persons;
 - relief for annual leave, sick leave, and family and community services leave;
 - relief for mandatory education; and
 - other factors including patient type (eg high dependency patient, “day only” patients, patients requiring close observation), teaching and research activities, provision of nurse escorts and ward geography.²⁷¹
- 8.134 The General Workload Calculation Tool is applied across NSW in appropriate wards in all public hospitals using a customised computer tool provided to the area health services by NSW Health.²⁷² The General Workload Calculation Tool is not applied to

intensive care units, high dependency units, Emergency Departments and operating theatres (amongst other areas of nursing).²⁷³

- 8.135 The General Workload Calculation Tool applies to about 30% of NSW Health's medical/surgical wards or units.²⁷⁴ Although the General Workload Calculation Tool calculates an appropriate number of staff, the nurses are still not necessarily on the ground for those units because of budgetary constraints.²⁷⁵
- 8.136 A common complaint during the Inquiry was that the General Workload Calculation Tool does not take into account the experience levels of nurses, which remains a matter for the professional judgment of the nurse unit manager.²⁷⁶ A very experienced registered nurse is counted in the same manner as a trainee enrolled nurse.
- A nurse unit manager at Coffs Harbour Base Hospital told me that the workload calculation tool looks at nursing hours per patient per day, with a trainee enrolled nurse who works an 8 hour shift being counted in the same way as a clinical nurse specialist.²⁷⁷ She pointed out that there is thus a fundamental fault in the tool, insofar as the trainee enrolled nurse cannot do the work that a Year 8 registered nurse can do, but they are counted in the same way.²⁷⁸
 - The Director of Nursing at Gosford Hospital told me that although everybody thought that the reasonable workload tool would be the "saving grace" for nurses when it came into being, her experience has been quite the opposite.²⁷⁹ She said that the tool fails to account for the skill mix, treats an assistant-in-nursing the same as an enrolled nurse, and does not give a true picture of how many nurses are needed on a shift-to-shift basis.²⁸⁰ She also stated that the tool does not account for nurses taking the time to sit down and talk to patients and do "all of those things that nursing once upon a time used to pride itself on in providing the total aspect of patient care".²⁸¹
 - An enrolled nurse at Nepean Hospital also observed that trainee enrolled nurses are counted as a "full" nurse for staffing purposes.²⁸² He stated that whilst they are "a pair of hands", trainee enrolled nurses do not have the clinical knowledge of a fully-qualified staff member, and should not be counted as such.²⁸³
 - A nurse at Coffs Harbour Hospital likewise told me that trainee enrolled nurses are counted as a nurse for the purposes of staff-patient ratios, and the lack of differentiation between the skill levels is unsafe.²⁸⁴
 - A clinical nurse educator at Royal North Shore Hospital made the following observations about the impact of the operation of the tool on registered nurses:

"On my ward the nurse is given three patients to look after. If they have a trainee enrolled nurse with them, that is doubled to six patients because it's two staff and they are counted. In that instance, there is a lot more stress on the registered nurse because it has doubled her workload, as well as she then has to supervise the trainee enrolled nurse and keep an eye on her practice.

So it's overburdening the staff on the ward, and we find it potentially dangerous for the patient because when you have an overstretched registered nurse trying to juggle all this stuff, then there are potential problems for the patient, and you've got a trainee enrolled nurse who is probably not capable of recognising clinical problems."²⁸⁵
- 8.137 Obviously, a very experienced nurse is able to achieve far more on a shift than a newly trained enrolled nurse. To illustrate, a nurse at Bankstown Hospital informed me that patient "turnover" (that is, throughput) was sometimes a problem, as junior staff took

longer to attend to patient care tasks and length of stay in the Emergency Department may therefore be extended.²⁸⁶

- 8.138 As a matter of practical reality, it is difficult for the General Workload Calculation Tool to take account of patient acuity. It seems to me that it is impossible to predict actual patient acuity on any given day as rosters are prepared weeks or months in advance, so any tool is imperfect to that extent. The problem of patient acuity was highlighted by a nurse at Nepean Hospital, who told me that the tool requires nurses to input bed numbers and the level of intensity.²⁸⁷ The tool then calculates the number of nurses and the skill mix required.²⁸⁸ She said that the tool is not suitable for some wards, however, because it does not reflect the relative acuity of the patients.²⁸⁹
- 8.139 Clearly, patient acuity is very significant in determining nurses' workloads. To illustrate, I have been told that hospitalised children under the age of 2 require 45% more routine nursing care.²⁹⁰
- 8.140 It seems that the General Workload Calculation Tool may be flawed in a number of respects but at the very least, the level of nurses' experience and training must be incorporated in it for the tool to be effective.

Skill mix

- 8.141 A common complaint during the Inquiry was that the "skill mix" in nursing has become too junior, with inadequate support for junior nurses, either in terms of education or supervision by more experienced nurses. I have discussed skill mix in detail in Chapter 13.

Consequences of understaffing and junior skill mix

- 8.142 As I have discussed in Chapter 13, one of the implications of understaffing and a junior skill mix is that there is not enough time for the senior nurses to supervise junior nurses. It also presents challenges in finding enough time to arrange and attend continuing education.
- 8.143 Understaffing also leads to nurses working a great deal of overtime, and becoming stressed and burnt out. Some of the overtime is unpaid, or in some cases there is pressure not to record it.
- For instance, I was told by a nurse at Bankstown Hospital that due to an attempt by the Director of Nursing to reduce the number of agency nurses, existing nursing staff in the operating theatres are working extremely hard under difficult circumstances, and doing enormous amounts of overtime to cover the theatre lists.²⁹¹
 - A witness at Albury Hospital claimed that all managers and senior nurses at the hospital did at least 2 hours unpaid overtime per day.²⁹²
 - A nurse at Concord Hospital told me that although there is a process for the claiming of "time in lieu", it does not work very effectively and there has been a lot of pressure on nurses not to formally record it.²⁹³

- As mentioned above, a midwife at Wollongong Hospital described the working conditions in that hospital's post-natal ward as "very unsafe".²⁹⁴ This witness informed me that she and her colleagues have started claiming overtime on the advice of their union.²⁹⁵ However, the Director of Maternity Services has indicated that midwives are not going to be paid their overtime, even though they are entitled to it as part of their award.²⁹⁶ Midwives are apparently being told that because overtime has to be pre-approved, it is not going to be paid if pre-approval is not obtained.²⁹⁷ Midwives have also been told that overtime will not be paid as they are not being sufficiently "time-efficient".²⁹⁸

8.144 In the context of understaffing, a clinical nurse educator at Coffs Harbour Base Hospital made the following observations in relation to retention of staff:

"I think if you decrease the workload per the existing staff, they may be retained for longer, because the acuity and the workload and the patient return to staff ratio is one of the biggest issues."²⁹⁹

8.145 A lack of sufficient time for nurses to care for patients leads to job dissatisfaction. A nurse at Nepean Hospital told me that the restructure of that hospital saw a number of senior nurses resign due to dissatisfaction and disappointment about what was happening with patients and staff.³⁰⁰ She described this dissatisfaction in the following terms:

"With the nurses on the floor, I have them in the office on numerous days, and they are often going home in tears and complaining that they don't have time to spend with their patients; they are just flat out trying to get patients into hospital or out of hospital, and the bit in the middle doesn't seem to be happening. Their concern is that the communication with families is less.

Once upon a time, you had enough time in a shift to actually spend time with a patient and their family, even a chat at the bedside. They don't have that time anymore because the pressure to try and free the beds up just precludes all that, and they go home dissatisfied, feeling, "Why am I doing this? I'm not going home feeling I've done a good day's work and done what the patient actually needed. I've done more what the hospital needed, but I don't feel I have done what the patients needed", and that is what they say every day. So I try to keep them going and help them along and give them ideas and suggestions, but it is very frustrating to see it happening every day."³⁰¹

8.146 The combined problems of understaffing and junior skill mix over prolonged periods can also have adverse consequences for patient care. I have outlined this in more detail in Chapter 13.

Solutions

8.147 In relation to "skill mix" problems, I have discussed in Chapter 13 the potential solutions of shared care and roster matching.

8.148 In respect of understaffing, some enterprising managers have overcome this difficulty through a willingness to employ all levels of nurses, whether nurse practitioners, assistants-in-nursing, endorsed enrolled nurses or trainee enrolled nurses.³⁰²

8.149 For example, the Emergency Department at Hornsby Hospital has adopted the philosophy of "the right person for the right job",³⁰³ which has resulted in a mix of

enrolled nurses and assistants-in-nursing as well as registered nurses, allowing a substantial increase in nursing numbers while controlling costs.³⁰⁴ This has also permitted registered nurses to do more advanced care, having been relieved of some of the more simple tasks.³⁰⁵

- 8.150 The hospital has also employed undergraduate nursing students as assistants-in-nursing, yielding a stream of newly qualified registered nurses interested in working in the Emergency Department.³⁰⁶ In so doing, the unit had fully recruited to their available positions as at 11 March 2008, and had a back-up waiting list.³⁰⁷ By employing trainees, the hospital exposed nurses-in-training to the Emergency Department early in their careers, and those nurses wanted to stay at the hospital upon completion of their registered nurse training, as they had developed loyalty to the department.³⁰⁸
- 8.151 The problems of understaffing and junior skill mix can be addressed, it seems to me, by the following combined strategies:
- (a) freeing up nurse unit managers to enable them to go back to spending the majority of their time engaged with patients in the wards, through the creation of a clinical assistant position as already recommended;
 - (b) providing a career path for senior clinical nurses to retain more of them on the wards as already recommended;
 - (c) implementing team nursing as I have recommended in Chapter 13;
 - (d) implementing widespread education for new nurses using modern technology as recommended in Chapter 10; and
 - (e) formally creating designated “student registered nurse” positions to provide nurses-in-training with experience in the ward environment as recommended in Chapter 10.

Changing roles for nurses

- 8.152 The shortage of skilled nurses in NSW means that we must use the nurses we have better. As the Chief Executive of the Greater Metropolitan Clinical Taskforce suggested to me, there should be greater use of skilled nurses in broader multi-disciplinary roles.³⁰⁹
- 8.153 Expansion of the scope of nursing practice has 2 aspects:
- (a) giving nurses greater roles than they presently have where it is nonetheless within their competencies (or would, with some further training, be within their competencies); and
 - (b) taking away duties that are not the best use of a nurse’s skills. I have discussed this in Chapter 11.

Resistance from other health professionals

- 8.154 It seems fairly plain to me that doing either will encounter great resistance. Where it is proposed to give nurses a greater role, resistance is likely from those health professionals, such as doctors, who see their traditional roles being eroded. A senior representative of NSW Health made the following comments in this context:

“Nurse practitioners have been one of the most successful things we have done, but because of the medical profession blocking it, it took 10 years longer than was

necessary to get those services on the ground for the patients. But the nurses could move in to nurse anaesthetic roles, endoscopy, a lot of the procedural areas. That is being blocked by the medical profession because procedural medicine is an area of quite good income.”³¹⁰

Resistance from nurses

- 8.155 Where it is proposed to take away duties from nurses, resistance is likely from the nurses themselves, and their industrial associations. A senior representative of NSW Health confirmed that the nursing profession is resistant to some aspects of role re-design, one of NSW Health’s critical areas for reform, stating:

“This is one of the areas we just simply can’t push through... I think in operating theatres we don’t have to have all registered nurses. ... [I]n ... dialysis nursing and transplantation, in what’s called chronic maintenance dialysis you do not need a registered nurse, that could be done by a technician.

I think in long-term aged care facilities, they are currently staffed by RNs and ENs, and in the Commonwealth reform in this area, residential care workers do that work. I think if we could get nurses out of a lot of these areas, we actually would solve a lot of the workforce supply issues which are literally around the corner in the next five to six years.

If you say this to the nursing profession in any setting, they ... become very upset.”³¹¹

- 8.156 Another representative of NSW Health summarised the problem of resistance from the nursing profession in the following way:

“There is quite a bit of mythology around what you can and can’t do and who can and can’t do what that we seem to spend an inordinate amount of time trying to clarify with nurses.”³¹²

- 8.157 That representative of NSW Health also told me, it appears nurses are at times willing to train someone’s parents or partner to undertake nursing tasks at home or in aged care facilities where there is no supervision available, but they will not let enrolled nurses do the same tasks in hospital where supervision can be afforded to them.³¹³ This is illogical and a nonsense.³¹⁴

Examples from the United Kingdom

- 8.158 There are some useful examples of role re-design having been done successfully overseas.
- 8.159 For instance, because of the lack of supply of doctors and nurses in the United Kingdom, jobs traditionally done by doctors and nurses have had to be allocated to other branches of the health profession.³¹⁵
- Nurses in the United Kingdom undertake endoscopies, and nurse surgeons perform carpal tunnel surgery.³¹⁶
 - The United Kingdom also has nurse-led assessments for cancer.³¹⁷ Once the patient is referred by their general practitioner, all tests are done by a nurse: the patient will only see a doctor at the end – once all test results are completed – and will not even see a doctor if there is no issue arising from the results.³¹⁸

- 8.160 One registered nurse at Armidale Hospital responded to these United Kingdom examples by saying:

"... I think it's probably something that could work ... provided that they're given adequate training and proper supervision ..."³¹⁹

- 8.161 A doctor who works in the Emergency Department at Sutherland Hospital told the Inquiry that when she worked in the United Kingdom, nurses took all "non-doctor" tasks out of doctors' hands.³²⁰ She said that working in the United Kingdom was not as stressful as working in Australia.³²¹ She saw 10 patients per hour (6 minutes per patient) and there was an average waiting time for patients of 20 minutes.³²²

In the operating theatre

- 8.162 Some changes to nurses' roles have been made in NSW in the operating theatre, but, as I understand it, against great and sustained resistance.
- 8.163 NSW Health ran a program through the College of Nursing to enable enrolled nurses to have an instrument role in the operating suite.³²³ The nurses receive 10 days training at the College of Nursing together with supervised clinical experience in their own workplace.³²⁴ In 2003 the Prince of Wales and Sydney Children's Hospital produced a 12 month pilot program which saw the endorsed enrolled nurse in the role of the instrument nurse.³²⁵ I understand that this pilot program was so successful that this model of care has been reproduced widely across NSW.³²⁶
- 8.164 Whilst the NSW Operating Theatre Association conceded that the introduction of endorsed enrolled nurses as instrument nurses had not compromised patient care (because a registered nurse supervises patient care at all times)³²⁷ the NSW Nurses' Association told me that operating theatre registered nurses would not wish to go to the ward environment if role substitution was implemented, and many of those nurses would probably be lost from the profession were that to occur.³²⁸
- 8.165 I also heard evidence that assistants-in-nursing are used in operating theatres, under the supervision of registered nurses, in Victoria.³²⁹
- 8.166 The nurse manager of operating theatres at Tamworth Base Hospital told me that in his view, there was no problem in having enrolled nurses doing an extra course to give them the relevant qualifications in instrument usage in the operating theatre, provided that staffing ratios were increased to allow supervision, perhaps in the form of a clinical nurse educator to oversee the work in the interests of maintaining standards.³³⁰ He considered that if registered nurse input was to be taken away from theatres, it needed to be substituted by proper training and clinical supervision.³³¹
- 8.167 This simple example of using non-registered nurses in the operating theatre indicates the impediments to change and the resistance to change which accompanies what is otherwise sensible workforce redesign. What was proposed was logical in that it meant that tasks were being allocated to people capable of doing them, it did not compromise patient care, it was cost effective and it helped address workforce shortages. Yet it was fiercely resisted for largely historical reasons (ie registered nurses have always done the job) which had no rational basis and also resisted from a purely industrial perspective. Such division and resistance is unhelpful, particularly, since, so it seems to me that change in the essential area of workforce redesign and flexibility is only going to increase in the future as experienced nurses become an increasingly precious resource.

Nurse practitioners

- 8.168 The best example, at present, of the changing role of nurses, and obstacles to such changes, is the role of nurse practitioner.
- 8.169 Whilst I was provided with varying estimates, it seems that there are presently about 120 nurse practitioners in NSW.³³² It takes about 3½ years to become a nurse practitioner, and aspiring nurses are required to demonstrate about 5,000 hours of practice at an advanced level.³³³
- 8.170 Australia-wide, the top 10 areas of practice for nurse practitioners are set out in the table below.

Table 8.6 Top 10 areas of Nurse Practitioners practice (of 238 nurse practitioners in Australia in 2007)³³⁴

	Area of practice	%
1	Emergency Department	22.7%
2	Mental health	5.9%
3	Rural / remote / generalist	5.4%
4	Paediatrics	4.9%
5	Diabetes	4.4%
6	Wound management	4.4%
7	Neonatal / neonatal intensive care	3.9%
8	Palliative care	3.4%
9	Renal / nephrology	3.4%
10	Aged care	3.4%

- 8.171 During the Inquiry, I heard about the work being done by a number of nurse practitioners.
- A nurse practitioner in the Emergency Department at Sydney Children's Hospital sees a specific range of patients that have been locally agreed as being within the scope of her practice, and works under guidelines to manage those patients autonomously or collaboratively, depending on the condition they present with.³³⁵ She is authorised to prescribe medication and to refer patients for diagnostic tests upon which to base a diagnosis within her scope of practice and agreed guidelines.³³⁶
 - Shoalhaven District Memorial Hospital has a nurse practitioner who does sutures, intravenous lines, and prescribes certain listed drugs.³³⁷ There are clear parameters as to what he can and cannot do, and the system works well.³³⁸
 - A nurse practitioner works in the Emergency Department at Wollongong Hospital between 1.30 pm and 9.30 pm on Saturdays,³³⁹ when there are not enough specialists or supervised junior doctors.³⁴⁰ I have no doubt that nurse practitioner is a valuable and experienced resource for doctors and nurses alike.
 - A nurse practitioner works at Port Macquarie Hospital in aged care.³⁴¹ I was told that she has ensured that 40 of the elderly patients she treats do not need to go to hospital each month, and that in one month she saved 169 bed days.³⁴²
 - The Emergency Department at Mona Vale Hospital is trialling the use of nurse practitioners.³⁴³ The nurse practitioners each see 20 patients per day, and this seems to be working very well to alleviate demand on the Emergency Department.³⁴⁴

- A Diabetes Nurse Practitioner works with the Diabetes Day Care Programme at The Children’s Hospital at Westmead.³⁴⁵ I have been told that this nurse practitioner has been instrumental in avoiding hospital admissions, improving access to appropriate and timely care, and freeing up inpatient beds.³⁴⁶
- The Children’s Hospital at Westmead also has a Paediatric Nurse Practitioner Ward Referral Service, which extends paediatric critical care services to acutely ill children in the hospital outside of the paediatric intensive care unit,³⁴⁷ such as administering infusions and providing respiratory support.³⁴⁸

Response of other health professionals

- 8.172 The Australian Nurse Practitioner Association told me that the main impediment to the implementation of nurse practitioners relates to the lack of understanding and ignorance from other health disciplines about the role.³⁴⁹
- 8.173 The NSW College of Nursing told me that although consumer and community acceptance and support for the introduction of nurse practitioners was extremely high, resistance was strong from some within the medical profession.³⁵⁰ This resistance derived from the perception that the nurse practitioner role sought to erode the traditional role of doctors in the practice of medicine.³⁵¹

Doctor support

- 8.174 Some doctors support nurse practitioners, although of those to whom I spoke, they were in the minority. The Medical Director of the New England Critical Care Network acknowledged this hostility but told me that nurse practitioners are particularly useful in rural areas where there are not enough GPs:
- “I am actually a fan of nurse practitioners in these areas. I know the rural doctors would hate to hear me say that; they feel threatened by that.
- ... [T]hey see it as the thin end of the wedge. I don’t think they can have it both ways, they can’t recognise there is a deficiency but then say, ‘You can’t let anyone else do that job, you just have to do without or wait for some miracle to occur.’ So I’m a fan. I think models of care in places that can’t get GPs or where the GPs are not up to the task, they need some other models of care, and that involves other people doing doctor work, and nurse practitioners, the ones that I have had experience with, are terrific.”³⁵²
- 8.175 A doctor at The Children’s Hospital at Westmead told me that the use of more nurse practitioners would be an effective use of the health dollar.³⁵³ The witness said that nurse practitioners are very good at what they do – doing a lot of the work that nurses and doctors can do, but more efficiently.³⁵⁴ The witness also observed that nurse practitioners are less likely than junior doctors to move around the health system.³⁵⁵
- 8.176 Another doctor also supported the expansion of the role of nurse practitioners in Emergency Departments.³⁵⁶ He stated that at the Emergency Department at Sutherland Hospital, nurses are actively encouraged to extend their work practices, although this was limited by “a conservative nursing and medical belief that nurses ‘are not able to do things’”.³⁵⁷ He observed that it is inefficient, however, to use doctors to take blood, insert cannulas and provide analgesia to patients.³⁵⁸

Doctor resistance

- 8.177 A nurse practitioner with whom I spoke at Quirindi Hospital told me that the major blockage to her work was lack of acceptance from local doctors.³⁵⁹
- 8.178 A representative of the Australasian College for Emergency Medicine told me that he does not consider the nurse practitioner role to have yet demonstrated its effectiveness as a useful means of job substitution.³⁶⁰ The College also told me that the Emergency Department nurse practitioner salary is equivalent to that of a senior registrar trainee (4th year), yet the role is vastly more limited than all junior medical staff roles in its ability to deliver definitive care across the spectrum of emergency department patients.³⁶¹ Curiously, although complaining of severe workforce shortages in Emergency Departments, the college does not support the development of nurse practitioner roles, suggesting that the existence of the role derives from “political correctness”.³⁶²
- 8.179 Similarly, the Australian Medical Association and Australian Salaried Medical Officers Federation expressed the view that the nurse practitioner model was deeply flawed.³⁶³ I was told that the difficulty with nurse practitioners is that they are put into Emergency Departments and report to the Director of Nursing rather than the Director of the Emergency Department.³⁶⁴ In their joint submission, I was told that the Australian Medical Association supports nurses working in expanded roles if they are under the supervision of a medical practitioner.³⁶⁵
- 8.180 One doctor submitted that the introduction of nurse practitioners into hospitals’ Emergency Departments is a model of care that has been “forcibly implemented” by NSW Health against senior medical advice, and with no proven benefit.³⁶⁶ This doctor stated that nurse practitioners require significant training and, at best, have demonstrated that they are “not inferior” to junior medical staff in terms of patient care and safety.³⁶⁷
- 8.181 A Senior Registrar working in the intensive care area at Prince of Wales Hospital submitted that there may be a subtle disincentive for nurse practitioners to consult doctors in Emergency Departments for advice, as to do so would be “an admission of their limitations and a challenge to their professional pride”.³⁶⁸

Future of nurse practitioners

- 8.182 I have been told that there is a lack of strategic planning as to the future of nurse practitioners across NSW, in circumstances where nurse practitioners could be very beneficial.³⁶⁹
- 8.183 The nurse practitioner from the Sydney Children's Hospital (noted above) told me that of approximately 120 authorised nurse practitioners in NSW, around 30 are not actually filling nurse practitioner positions.³⁷⁰ She said that this was because the area health services did not want the service and, within her own area health service, there was poor understanding of and support for the role.³⁷¹
- 8.184 It seems to me that given the ageing population, current projections with respect to supply of nursing places, and the fact that by 2011 NSW public hospitals will lose 22% of their nurses, the present system cannot be maintained using current demarcations.
- 8.185 Clearly, the lines that have been drawn as to what doctors, nurses and allied health professionals do must be addressed in order to maximise the resources our public hospitals do have. The area health services need to actively promote the work of nurse practitioners and use them to re-assign areas of clinical practice in our hospitals, as it is

clear that nurse practitioners can be developed into a role that is integral to the clinical professions.

- 8.186 It may be necessary to promulgate protocols as to the clinical decisions and procedures that may be made and undertaken by nurse practitioners. This will provide certainty as to the scope of the nurse practitioner role, and promote acceptance of it. NSW Health should instruct managers to ensure that nurse practitioners are directed to work in all areas for which they are qualified and that they are not to be used as if they were stop-gap or second-best clinicians.

Recommendation 25: *I recommend that NSW Health, in order to address the current shortages in the nursing workforce, consider and implement, if appropriate, the following:*

- (a) *The creation of a new clinical designation for registered nurses with over 10 years experience who continue to carry out patient clinical care, entitled "Senior Registered Nurse" with appropriate competency based increments.*
- (b) *The allocation of funding for more nurse practitioner positions across NSW, particularly in rural and remote areas, and in hospitals where it is hard to employ doctors.*
- (c) *A redesign of the General Workload Calculation Tool to take into account nurses' designation (clinical nurse specialist, registered nurse, enrolled nurse, trainee enrolled nurse, assistant-in-nursing) and years of nursing experience, together with the capacities created by a team-based nursing medical of care.*

- ¹ Submission of the NSW Nurses' Association, March 2008, SUBM.042.0335 at 10.
- ² NSW Health briefing, 4 April 2008, transcript 83.6-14 and 89.5-6.
- ³ NSW Health briefing, 4 April 2008, transcript 41.38; NSW Health, *Special Commission of Inquiry Presentations: NSW Health Workforce*, 4 April 2008, at 4.
- ⁴ NSW Health Briefing, 4 April 2008, transcript 82.44-47.
- ⁵ Letter from NSW Health to Special Commission of Inquiry, 4 September 2008.
- ⁶ Section 3(1), *Nurses and Midwives Act 1991* (NSW).
- ⁷ Letter from Nurses & Midwives Board of NSW to Special Commission of Inquiry, 12 September 2008.
- ⁸ NSW Health Briefing, 4 April 2008, transcript 41.38; NSW Health, *Special Commission of Inquiry Presentations: NSW Health Workforce*, 4 April 2008, at 4.
- ⁹ Australian Nursing & Midwifery Council, *Code of Ethics for Midwives in Australia*, 2005, Australian Nursing & Midwifery Council at 1.
- ¹⁰ Section 3(1), *Nurses & Midwives Act 1991* (NSW).
- ¹¹ NSW Health Briefing, 4 April 2008, transcript 41.38; NSW Health, *Special Commission of Inquiry Presentations: NSW Health Workforce*, 4 April 2008, at 4.
- ¹² Section 3(1), *Nurses and Midwives Act 1991* (NSW).
- ¹³ See s.27 of the *Nurses and Midwives Act 1991* (NSW) ("the Act") and cl.5(1) of the *Nurses and Midwives Regulation 2008*, the latter of which provides that for the purposes of s.27 of the Act the prescribed tuition is the training in nursing given by the hospital or institution that the person attended and the prescribed examinations are those conducted for the purposes of s.27(1)(a)(ii) of the Act by the TAFE Commission or any accredited providers of vocational training or higher education that are approved by the Board.

-
- 14 Letter from Nurses & Midwives Board of NSW to Special Commission of Inquiry, 12 September 2008.
- 15 NSW Health Briefing, 4 April 2008, transcript 94.45-95.05.
- 16 NSW Health Briefing, 4 April 2008, transcript 94.46-47.
- 17 NSW Health Briefing, 4 April 2008, transcript 95.2-4.
- 18 NSW Health Briefing, 4 April 2008, transcript 41.38; NSW Health, *Special Commission of Inquiry Presentations: NSW Health Workforce*, 4 April 2008, at 4.
- 19 For a detailed statement of some of the tasks undertaken by assistants-in-nursing, see the evidence of Elisabeth Allen, Coffs Harbour hearing, 27 March 2008, transcript 998.42-44.
- 20 Elisabeth Allen, Coffs Harbour hearing, 27 March 2008, transcript 998.42-44.
- 21 Elisabeth Allen, Coffs Harbour hearing, 27 March 2008, transcript 999.8-20.
- 22 Seek Learning, Healthcare and Medical Courses, <http://www.seeklearning.com.au/tafe/certificate-3-in-aged-care-work.asp> (5 November 2008).
- 23 NSW Health (Statewide Services Development Branch), *Guide to the Role Delineation of Health Services*, 3rd edition, 2002, NSW Department of Health at 89.
- 24 NSW Nurses' Association submission, September 2008, SUBM.095.0001 at 31.
- 25 NSW Health (Statewide Services Development Branch), *Guide to the Role Delineation of Health Services*, 3rd edition, 2002, NSW Department of Health at 89.
- 26 Veronica Croome, Gosford hearing, 10 March 2008, transcript 87.4-9.
- 27 NSW Health (Statewide Services Development Branch), *Guide to the Role Delineation of Health Services*, 3rd edition, 2002, NSW Department of Health at 90.
- 28 Marilyn Hibbert, Hornsby hearing, 11 March 2008, transcript 185.19-34.
- 29 NSW Health (Statewide Services Development Branch), *Guide to the Role Delineation of Health Services*, 3rd edition, 2002, NSW Health Department at 89.
- 30 Peter Campbell, Royal North Shore Hospital hearing, 2 April 2008, transcript 1192.16-20.
- 31 Louise Waymouth, Gosford hearing, 10 March 2008, transcript 140.39-42.
- 32 Peter Campbell, Royal North Shore Hospital hearing, 2 April 2008, transcript 1192.24-26.
- 33 Cashin, A et al, "Clinical Initiatives Nurses and Nurse Practitioners in the Emergency Department: What's in a Name?" (2007) 10 Australasian Emergency Nursing Journal 73 at 74.
- 34 Cashin, A et al, "Clinical Initiatives Nurses and Nurse Practitioners in the Emergency Department: What's in a Name?" (2007) 10 Australasian Emergency Nursing Journal 73 at 74 and 77.
- 35 Cashin, A et al, "Clinical Initiatives Nurses and Nurse Practitioners in the Emergency Department: What's in a Name?" (2007) 10 Australasian Emergency Nursing Journal 73 at 77.
- 36 NSW Health (Statewide Services Development Branch), *Guide to the Role Delineation of Health Services*, 3rd edition, 2002, NSW Department of Health at 91.
- 37 Letter from NSW Health to Special Commission of Inquiry, 4 September 2008.
- 38 NSW Health (Statewide Services Development Branch), *Guide to the Role Delineation of Health Services*, 3rd edition, 2002, NSW Department of Health at 91.
- 39 Letter from NSW Health to Special Commission of Inquiry, 4 September 2008.
- 40 Letter from NSW Health to Special Commission of Inquiry, 6 November 2008.
- 41 Letter from NSW Health to Special Commission of Inquiry, 6 November 2008.
- 42 Letter from NSW Health to Special Commission of Inquiry, 6 November 2008.
- 43 Letter from NSW Health to Special Commission of Inquiry, 6 November 2008.
- 44 Section 3(1), *Nurses and Midwives Act 1991* (NSW).
- 45 Letter from Nurses & Midwives Board of NSW to Special Commission of Inquiry, 12 September 2008.

-
- ⁴⁶ Subject to authorisation by the Director General of NSW Health, as provided by the *Poisons and Therapeutic Goods Act 1966* (NSW): letter from Nurses & Midwives Board of NSW to Special Commission of Inquiry, 12 September 2008.
- ⁴⁷ An applicant can satisfy the requirements without completion of a recognised masters degree: letter from Nurses & Midwives Board of NSW to Special Commission of Inquiry, 12 September 2008.
- ⁴⁸ Letter from Nurses & Midwives Board of NSW to Special Commission of Inquiry, 12 September 2008.
- ⁴⁹ Letter from Nurses & Midwives Board of NSW to Special Commission of Inquiry, 12 September 2008.
- ⁵⁰ Jennifer Kiddle, Mudgee hearing, 20 March 2008, transcript 735.39-44.
- ⁵¹ Jan Tweedie, Royal North Shore Hospital hearing, 14 March 2008, transcript 308.8-25.
- ⁵² Letter from Nurses & Midwives Board of NSW to Special Commission of Inquiry, 12 September 2008.
- ⁵³ Letter from Nurses & Midwives Board of NSW to Special Commission of Inquiry, 12 September 2008. I was told that birth data could not be extracted for approximately 2,150 registrants who would probably have been initially registered prior to implementation of the Board's computerised information systems, and are therefore presumed to be in the older age ranges.
- ⁵⁴ Australian Institute of Health & Welfare, *Nursing & Midwifery Labour Force 2005*, January 2008, Australian Institute of Health & Welfare, Canberra at viii.
- ⁵⁵ Australian Institute of Health & Welfare, *Nursing & Midwifery Labour Force 2005*, January 2008, Australian Institute of Health & Welfare, Canberra at viii.
- ⁵⁶ Australian Institute of Health & Welfare, *Nursing & Midwifery Labour Force 2005*, January 2008, Australian Institute of Health & Welfare, Canberra at viii.
- ⁵⁷ NSW Health, 2006 Profile of the Nursing Workforce in NSW, 2007, NSW Health Department, North Sydney, Table RN4.
- ⁵⁸ See, for example, Schofield, D and Beard, J, *Baby, Boomer Doctors and Nurses: Demographic Change and Transitions to Retirement*, (2005) 183(2) Medical Journal of Australia 80.
- ⁵⁹ Peter Campbell, Royal North Shore Hospital hearing, 2 April 2008, transcript 1200.21-27.
- ⁶⁰ Letter from NSW Health to Special Commission of Inquiry, 4 September 2008.
- ⁶¹ Veronica Croome, Gosford hearing, 10 March 2008, transcript 82.23-24.
- ⁶² Angela Monger, Gosford hearing, 10 March 2008, transcript 137.10-22.
- ⁶³ Information provided during visit to Goulburn Hospital on 28 February 2008.
- ⁶⁴ NSW Health Briefing, 31 March 2008, transcript 55.28-32.
- ⁶⁵ NSW Health Briefing, 31 March 2008, transcript 55.28-32.
- ⁶⁶ Letter from NSW Health to Special Commission of Inquiry, 4 September 2008, p. 3.
- ⁶⁷ Organisation for Economic Cooperation and Development, *Health at a Glance 2007: OECD Indicators*, 2007, OECD, at 59 and 61.
- ⁶⁸ Organisation for Economic Cooperation and Development, *Health at a Glance 2007: OECD Indicators*, 2007, OECD, at 55.
- ⁶⁹ Letter from NSW Health to Special Commission of Inquiry, 28 August 2008.
- ⁷⁰ Letter from NSW Health to Special Commission of Inquiry, 28 August 2008.
- ⁷¹ Letter from NSW Health to Special Commission of Inquiry, 28 August 2008
- ⁷² NSW Health, *Special Commission of Inquiry Presentations: NSW Health Workforce*, 4 April 2008, DOH.057.0074 at 20.
- ⁷³ NSW Health Briefing, 4 April 2008, transcript 51.37-41.
- ⁷⁴ Letter from NSW Health to Special Commission of Inquiry, 11 February 2008
- ⁷⁵ Letter from NSW Health to Special Commission of Inquiry, 11 February 2008
- ⁷⁶ NSW Health Briefing, 4 April 2008, transcript 51.27-28.

-
- 77 Meeting with Brett Holmes, NSW Nurses' Association, 26 June 2008.
- 78 NSW Health Briefing, 4 April 2008, transcript 83.6-8.
- 79 Letter from NSW Health to Special Commission of Inquiry, 4 September 2008.
- 80 NSW Health Briefing, 4 April 2008, transcript 95.10-12.
- 81 NSW Health Briefing, 4 April 2008, transcript 95.17-18.
- 82 NSW Health Briefing, 4 April 2008, transcript 83.2-6.
- 83 NSW Health Briefing, 4 April 2008, transcript 95.17-21.
- 84 NSW Health Briefing, 4 April 2008, transcript 93.23-25.
- 85 NSW Health Briefing, 4 April 2008, transcript 93.29-31.
- 86 NSW Health Briefing, 4 April 2008, transcript 93.25.
- 87 NSW Health Briefing, 4 April 2008, transcript 93.25-27.
- 88 Confidential Mudgee hearing, 20 March 2008, transcript 27.7-14.
- 89 NSW Health Briefing, 4 April 2008, transcript 98.30-32.
- 90 NSW Health Briefing, 4 April 2008, transcript 98.32-33.
- 91 NSW Health Briefing, 4 April 2008, transcript 98.33-36.
- 92 NSW Health Briefing, 4 April 2008, transcript 93.32-34.
- 93 NSW Health Briefing, 4 April 2008, transcript 93.34-36. NSW Health told me that the bonus is paid on a pro rata basis: NSW Health Briefing, 4 April 2008, transcript 93.42-46.
- 94 NSW Health Briefing, 4 April 2008, transcript, 97.11-12.
- 95 NSW Health Briefing, 4 April 2008, transcript 97.19-23.
- 96 NSW Health Briefing, 4 April 2008, transcript 97.12-100.
- 97 NSW Health Briefing, 4 April 2008, transcript 53.1-2.
- 98 *Commonwealth Code of Practice for the International Recruitment of Health Workers*, adopted by Commonwealth Health Ministers at Geneva on 18 May 2003.
- 99 Letter from NSW Health to Special Commission of Inquiry, 27 October 2008.
- 100 *Commonwealth Code of Practice for the International Recruitment of Health Workers*, adopted by Commonwealth Health Ministers at Geneva on 18 May 2003, at p. 2.
- 101 NSW Health Briefing, 4 April 2008, transcript 52.43-45.
- 102 Submission of members of the Wagga Wagga Base Hospital branch of the NSW Nurses' Association 23 April 2008, SUBM.073.0093 at 5.
- 103 NSW Health Briefing, 21 April 2008, transcript 23.46-24.3.
- 104 Submission of NSW Health, April 2008, SUBM.075.002 at 46-47.
- 105 Letter from NSW Health to Special Commission of Inquiry, 4 September 2008.
- 106 Letter from NSW Health to Special Commission of Inquiry, 4 September 2008.
- 107 Letter from NSW Health to Special Commission of Inquiry, 4 September 2008.
- 108 Letter from NSW Health to Special Commission of Inquiry, 4 September 2008.
- 109 Letter from NSW Health to Special Commission of Inquiry, 4 September 2008.
- 110 Veronica Croome, Gosford hearing, 10 March 2008, transcript 88.23-31. I was told that NSW Health's new budget program, Power Budget, which is being used in the South Eastern Sydney Illawarra Area Health Service, is difficult to use and very time-consuming, unless the user is an accountant or data manager: Anne Frew, Wollongong hearing, 14 April 2008, transcript 1647.15-26. Ms Frew said the previous budget system could be used easily: transcript 1647.19-21.
- 111 Submission of NSW Nurses' Association, September 2008, SUBM.095.0001 at 15.
- 112 Submission of NSW Nurses' Association, September 2008, SUBM.095.0001 at 16.
- 113 Anne Frew, Wollongong hearing, 14 April 2008, transcript 1649.2-6.
- 114 Lyndall Morris, Broken Hill hearing, 7 May 2008, transcript 2269.26-29.
- 115 Anne Frew, Wollongong hearing, 14 April 2008, transcript 1648.24-27.

-
- 116 Anne Frew, Wollongong hearing, 14 April 2008, transcript 1649.2.
- 117 Information provided during visit to Concord Repatriation General Hospital on 21 February 2008.
- 118 Information provided during visit to Concord Repatriation General Hospital on 21 February 2008.
- 119 Information provided during visit to Royal Prince Alfred Hospital on 14 February 2008.
- 120 Information provided during visit to Liverpool Hospital on 26 February 2008.
- 121 Rozlyn Norman, Tamworth hearing, 25 March 2008, transcript 798.17-20.
- 122 Stephen Rodwell, Coffs Harbour hearing, 27 March 2008, transcript 1031.25-30.
- 123 Emma Coyle, Hornsby hearing, 11 March 2008, transcript 246.47-248.20.
- 124 Debbie Skinner, Hornsby hearing, 11 March 2008, transcript 243.28-29 and 243.39-42.
- 125 Debbie Skinner, Hornsby hearing, 11 March 2008, transcript 243.41-42.
- 126 Debbie Skinner, Hornsby hearing, 11 March 2008, transcript 250.8-11.
- 127 Rose Hill, Royal North Shore Hospital hearing, 14 March 2008, transcript 283.10-30.
- 128 Lorraine Fitzgerald, Bankstown hearing, 13 May 2008, transcript 2843.23-26.
- 129 Lorraine Fitzgerald, Bankstown hearing, 13 May 2008, transcript 2843.24-25.
- 130 Karen Fernance, Bankstown hearing, 13 May 2008, transcript 2843.34-36.
- 131 Karen Fernance, Bankstown hearing, 13 May 2008, transcript 2843.43-44.
- 132 Karen Fernance, Bankstown hearing, 13 May 2008, transcript 2843.44-2844.1
- 133 Confidential hearing at the Inquiry's offices via video-link from Tweed Heads, 29 May 2008, transcript 9.35-40.
- 134 Information provided during visit to Corowa Hospital on 23 April 2008.
- 135 Information provided during visit to Corowa Hospital on 23 April 2008.
- 136 Information provided during visit to Corowa Hospital on 23 April 2008.
- 137 Jennifer Baroutis, Port Macquarie hearing, 28 March 2008, transcript 1097.25-31.
- 138 Frances Gearon, Orange hearing, 18 March 2008, transcript 588.9.19.
- 139 Pamela Barrett, Tweed Heads hearing, 29 April 2008, transcript 2387.29-30.
- 140 Pamela Barrett, Tweed Heads hearing, 29 April 2008, transcript 2386.29-31.
- 141 Pamela Barrett, Tweed Heads hearing, 29 April 2008, transcript 2386.31-32.
- 142 Demaris Wickham, Nepean Hospital hearing, 8 April 2008, transcript 1393.1-32.
- 143 Demaris Wickham, Nepean Hospital hearing, 8 April 2008, transcript 1393.32-34.
- 144 Demaris Wickham, Nepean Hospital hearing, 8 April 2008, transcript 1393.34-36.
- 145 Letter from NSW Health to Special Commission of Inquiry, 4 September 2008.
- 146 Submission of the NSW Nurses' Association, September 2008, SUBM.095.0001 at 6-7.
- 147 Pamela Barrett, Tweed Heads hearing, 29 April 2008, transcript 2386.13-16.
- 148 Pamela Barrett, Tweed Heads hearing, 29 April 2008, transcript 2386.16-19.
- 149 Pamela Barrett, Tweed Heads hearing, 29 April 2008, transcript 2386.21-26.
- 150 Elizabeth McCall, Lismore hearing, 28 April 2008, transcript 2257.42-2258.7.
- 151 Elizabeth McCall, Lismore hearing, 28 April 2008, transcript 2258.8-9.
- 152 Submission of NSW Nurses' Association, September 2008, SUBM.095.0001 at 7.
- 153 NSW Health, *Recruitment of Nurses and Midwives – Framework*, PD2008/045, 5 August 2008 at 2. This Policy Directive recently replaced Policy Directive PD2007/055, *Recruitment of Nurses and Midwives – Framework*, which was relevantly in the same terms as PD2008/045.
- 154 Letter from NSW Health to Special Commission of Inquiry, 4 September 2008.
- 155 Elizabeth McCall, Lismore hearing, 28 April 2008, transcript 2258.27-29.
- 156 Louise Waymouth, Gosford hearing, 10 March 2008, transcript 143.3-6 and 143.43-45.

-
- 157 Confidential Mudgee hearing, 20 March 2008, transcript 19.21-25.
- 158 Anne Frew, Wollongong hearing, 14 April 2008, transcript 1641.43-44.
- 159 Elizabeth McCall, Lismore hearing, 28 April 2008, transcript 2258.30-32.
- 160 Confidential Bankstown hearing, 13 May 2008, transcript 59.20-28.
- 161 Elizabeth McCall, Lismore hearing, 28 April 2008, transcript 2258.47-2259.3.
- 162 Lorraine Fitzgerald, Bankstown hearing, 13 May 2008, transcript 2843.23-26.
- 163 Kylie Stark, Sydney Children's Hospital hearing, 19 May 2008, transcript 3068.44-3069.15.
- 164 Rosalyn Ferguson, Hornsby hearing, 11 March 2008, transcript 232.30-35.
- 165 Michael McGlynn, Sydney Children's Hospital hearing, 19 May 2008, transcript 3091.20-23.
- 166 Kylie Stark, Sydney Children's Hospital hearing, 19 May 2008, transcript 3071.10-14.
- 167 Information provided during visit to Corowa Hospital on 23 April 2008.
- 168 See the evidence of Charles Lawrie and Rosalyn Ferguson, Hornsby hearing, 11 March 2008, transcript 231.10-232.13
- 169 Karen Fernance, Bankstown hearing, 13 May 2008, transcript 2843.43-44.
- 170 Karen Fernance, Bankstown hearing, 13 May 2008, transcript 2843.44-2844.1.
- 171 Lyndall Morris, Broken Hill hearing, 7 May 2008, transcript 2671.34-2672.3.
- 172 Veronica Croome, Gosford hearing, 10 March 2008, transcript 88.47-89.11.
- 173 Ann Mann, Dubbo hearing, 19 March 2008, transcript 675.47-676.11.
- 174 Susan Tait, Wollongong hearing, 14 April 2008, transcript 1651.2-13.
- 175 Susan Tait, Wollongong hearing, 14 April 2008, transcript 1651.14-19.
- 176 Susan Tait, Wollongong hearing, 14 April 2008, transcript 1651.22-25.
- 177 Anne Frew, Wollongong hearing, 14 April 2008, transcript 1651.32-34.
- 178 Anne Frew, Wollongong hearing, 14 April 2008, transcript 1649.43-45.
- 179 Anne Frew, Wollongong hearing, 14 April 2008, transcript 1650.3-5.
- 180 Anne Frew, Wollongong hearing, 14 April 2008, transcript 1650.6-9.
- 181 Jennifer Baroutis, Port Macquarie hearing, 28 March 2008, transcript 1098.29-38.
- 182 Elizabeth McCall, Lismore hearing, 28 April 2008, transcript 2261.3-8.
- 183 Michael McGlynn, Sydney Children's Hospital hearing, 19 May 2008, transcript 3091.12-20.
- 184 See the evidence of: Jennifer Baroutis, Port Macquarie hearing, 28 March 2008, transcript 1097.40-1098.6; Emma Coyle, Hornsby hearing, 11 March 2008, transcript 247.22-41.
- 185 Jennifer Baroutis, Port Macquarie hearing, 28 March 2008, transcript 1098.8-13.
- 186 Jennifer Baroutis, Port Macquarie hearing, 28 March 2008, transcript 1098.20-23.
- 187 NSW Health Briefing, 2 September 2008, transcript 2.41; NSW Health Briefing, 4 April 2008, transcript 99.32-34.
- 188 NSW Health Briefing, 2 September 2008, transcript 3.20-23.
- 189 NSW Health Briefing, 2 September 2008, transcript 3.23-25.
- 190 NSW Health Briefing, 2 September 2008, transcript 3.31-33.
- 191 NSW Health Briefing, 2 September 2008, transcript 7.44-46.
- 192 NSW Health Briefing, 2 September 2008, transcript 7.46-8.2.
- 193 NSW Health Briefing, 2 September 2008, transcript 8.24-28.
- 194 NSW Health Briefing, 2 September 2008, transcript 8.34-37.
- 195 NSW Health Briefing, 2 September 2008, transcript 9.1-4.
- 196 NSW Health Briefing, 2 September 2008, transcript 9.6-14.
- 197 NSW Health Briefing, 2 September 2008, transcript 16.43-46.
- 198 NSW Health Briefing, 2 September 2008, transcript 17.31-33.
- 199 NSW Health Briefing, 2 September 2008, transcript 14.37-38.

-
- 200 NSW Health Briefing, 2 September 2008, transcript 14.38-39.
- 201 NSW Health Briefing, 2 September 2008, transcript 14.40-42.
- 202 NSW Health Briefing, 2 September 2008, transcript 14.40-15.1.
- 203 NSW Health Briefing, 4 April, 2008, transcript 76.35-38; NSW Health, *Special Commission of Inquiry Presentations: NSW Health Workforce*, 4 April 2008, at 38.
- 204 NSW Health Briefing, 4 April 2008, transcript 76.37-38.
- 205 NSW Health Briefing, 4 April 2008, transcript 101.31-40.
- 206 Information provided during visit to Concord Repatriation General Hospital on 21 February 2008.
- 207 Information provided during visit to Concord Repatriation General Hospital on 21 February 2008
- 208 Jane Morley, Westmead hearing, 26 May 2008, transcript 3208.47-3209.2.
- 209 Jane Morley, Westmead hearing, 26 May 2008, transcript 3209.2-9.
- 210 Peter Roberts, Hornsby hearing, 11 March 2008, transcript 194.16-21.
- 211 Confidential submission, 25 March 2008, SUBM.009.0150 at 4.
- 212 Sally Torr, Bourke hearing, 9 May 2008, transcript 2723.18-25.
- 213 Veronica Croome, Gosford hearing, 10 March 2008, transcript 84.12-18.
- 214 NSW Health Briefing, 4 April 2008, transcript 82.43-44.
- 215 Veronica Croome, Gosford hearing, 10 March 2008, transcript 84.19-23.
- 216 Christopher Dolan, public hearing at Inquiry's offices via video-link from John Hunter Hospital, 30 May 2008, transcript 3249.10-15.
- 217 Christopher Dolan, public hearing at Inquiry's offices via video-link from John Hunter Hospital, 30 May 2008, transcript 3249.15-20.
- 218 Meeting with Warren and Michelle Anderson, 7 March 2008.
- 219 Meeting with Warren and Michelle Anderson, 7 March 2008.
- 220 Information provided during visit to Oberon Multi-Purpose Service on 17 March 2008.
- 221 Information provided during visit to Oberon Multi-Purpose Service on 17 March 2008.
- 222 Information provided during visit to Oberon Multi-Purpose Service on 17 March 2008.
- 223 Confidential Westmead Children's Hospital hearing, 15 May 2008, transcript 7.14-26.
- 224 Confidential Westmead Children's Hospital hearing, 15 May 2008, transcript 7.22-24.
- 225 Lorraine Fitzgerald, Bankstown hearing, 13 May 2008, transcript 2830.40-41.
- 226 Confidential Bankstown hearing, 13 May 2008, transcript 64.16-31.
- 227 Confidential Bathurst hearing, 17 March 2008, transcript 18.38-39.
- 228 Confidential Bathurst hearing, 17 March 2008, transcript 18.45-46.
- 229 Confidential Bathurst hearing, 17 March 2008, transcript 19.9-14.
- 230 Confidential Bathurst hearing, 17 March 2008, transcript 19.14-44.
- 231 Confidential Bathurst hearing, 17 March 2008, transcript 21.34-36.
- 232 Confidential hearing at the Inquiry's offices via video-link from Wagga Wagga, 30 May 2008, transcript 11.4-8.
- 233 Confidential hearing at the Inquiry's offices via video-link from Wagga Wagga, 30 May 2008, transcript 11.8-9.
- 234 Ian Incoll, Gosford hearing, 10 March 2008, transcript 55-34-41.
- 235 John Alchin, Gosford hearing, 10 March 2008, transcript 140.21-24.
- 236 Submission of NSW College of Nursing, March 2008, SUBM.013.0073 at 5.
- 237 Submission of NSW College of Nursing, March 2008, SUBM.013.0073 at 5.
- 238 Jan Tweedie, Royal North Shore Hospital hearing, 14 March 2008, transcript 310.8-16.
- 239 Jan Tweedie, Royal North Shore Hospital hearing, 14 March 2008, transcript 311.27-31.

-
- 240 Nicholas Marlow, Royal North Shore Hospital hearing, 14 March 2008, transcript 319.1-5.
- 241 Confidential Wollongong hearing, 14 April 2008, transcript 48.27-28.
- 242 Confidential Wollongong hearing, 14 April 2008, transcript 52.33-37.
- 243 Confidential Wollongong hearing, 14 April 2008, transcript 48.28-30.
- 244 Confidential Wollongong hearing, 14 April 2008, transcript 48.37-38.
- 245 Confidential Wollongong hearing, 14 April 2008, transcript 48.39-40.
- 246 Confidential Wollongong hearing, 14 April 2008, transcript 48.40-43.
- 247 Confidential Wollongong hearing, 14 April 2008, transcript 48.44.
- 248 Ann Mann, Dubbo hearing, 19 March 2008, transcript 672.27-40.
- 249 Submission of Sally Sutherland-Fraser on behalf of the Perioperative Managers Committee of South Eastern Sydney Illawarra Health Service, 28 March 2008, SUBM.022.0199 at 2.
- 250 Submission of Sally Sutherland-Fraser on behalf of the Perioperative Managers Committee of South Eastern Sydney Illawarra Health Service, 28 March 2008, SUBM.022.0199 at 2.
- 251 Confidential Armidale hearing, 26 March 2008, transcript 8.30-33.
- 252 Stephen Rodwell, Coffs Harbour hearing, 27 March 2008, transcript 1026.3-6.
- 253 David Smith, Tamworth hearing, 25 March 2008, transcript 789.10-790.38.
- 254 Jane Morley, Westmead hearing, 26 May 2008, transcript 3208.19-22.
- 255 Jane Morley, Westmead hearing, 26 May 2008, transcript 3208.19-22.
- 256 Alan Gardo, Royal Prince Alfred Hospital hearing, 20 May 2008, transcript 3122.12-13.
- 257 Alan Gardo, Royal Prince Alfred Hospital hearing, 20 May 2008, transcript 3122.15-23.
- 258 Alan Gardo, Royal Prince Alfred Hospital hearing, 20 May 2008, transcript 3122.26-28.
- 259 Janet Long, Nepean Hospital hearing, 8 April 2008, transcript 1348.40-41.
- 260 Janet Long, Nepean Hospital hearing, 8 April 2008, transcript 1348.45-1349.8.
- 261 Confidential submission, 27 March 2008, SUBM.027.0437 at 1.
- 262 Lorraine Fitzgerald, Bankstown hearing, 13 May 2008, transcript 2831.5-7.
- 263 Lorraine Fitzgerald, Bankstown hearing, 13 May 2008, transcript 2831.7-11.
- 264 Margo MacKenzie, Mudgee hearing, 20 March 2008, transcript 761.20-21.
- 265 Margo MacKenzie, Mudgee hearing, 20 March 2008, transcript 761.21-29.
- 266 Andrea Delprado, Liverpool hearing, 17 April 2008, transcript 1890.23-27.
- 267 Andrea Delprado, Liverpool hearing, 17 April 2008, transcript 1890.29.
- 268 NSW Health briefing, 4 April 2008, transcript 75.36-42.
- 269 Submission of the NSW Nurses' Association, September 2008, SUBM.095.0001 at 22.
- 270 Anne Frew, Wollongong hearing, 14 April 2008, transcript 1642.21-24.
- 271 See clause 53(iii)(b)(1)-(3), section II of the *Public Health Systems Nurses' & Midwives' (State) Award*.
- 272 Letter from NSW Health to Special Commission of Inquiry, 4 September 2008.
- 273 See clause 53(iii)(b)(12), section II of the *Public Health Systems Nurses' & Midwives' (State) Award*.
- 274 Submission of the NSW Nurses' Association, September 2008, SUBM.095.0001 at 24.
- 275 Anne Frew, Wollongong hearing, 14 April 2008, transcript 1642.26-28.
- 276 Submission of the NSW Nurses' Association, September 2008, SUBM.095.0001 at 24.
- 277 Susan Saunders, Coffs Harbour hearing, 27 March 2008, transcript 1012.5-9.
- 278 Susan Saunders, Coffs Harbour hearing, 27 March 2008, transcript 1012.9-11.
- 279 Veronica Croome, Gosford Hospital hearing, 10 March 2008, transcript 85.9-13.
- 280 Veronica Croome, Gosford Hospital hearing, 10 March 2008, transcript 85.13-23.
- 281 Veronica Croome, Gosford Hospital hearing, 10 March 2008, transcript 85.25-30.

- 282 Jason Mullavey, Nepean Hospital hearing, 8 April 2008, transcript 1365.43-1366.1.
- 283 Jason Mullavey, Nepean Hospital hearing, 8 April 2008, transcript 1366.37-40.
- 284 Amanda Short, Coffs Harbour hearing, 27 March 2008, transcript 953.35-954.1.
- 285 Jean McKenzie-Edge, Royal North Shore Hospital hearing, 2 April 2008, transcript 1253.40-1254.7.
- 286 Confidential Bankstown hearing, 13 May 2008, transcript 61.7-10.
- 287 Suzanne Samuels, Nepean hearing, 8 April 2008, transcript 1394.15-16.
- 288 Suzanne Samuels, Nepean hearing, 8 April 2008, transcript 1394.17-19.
- 289 Suzanne Samuels, Nepean hearing, 8 April 2008, transcript 1394.19-26.
- 290 Confidential submission, April 2008, SUBM.041.0052 at 9.
- 291 Confidential Bankstown hearing, 13 May 2008, transcript 36.23-46.
- 292 Confidential Albury hearing, 23 April 2008, transcript 35.13-17.
- 293 Susan Monaro, Concord hearing, 24 April 2008, transcript 2132.41-44.
- 294 Confidential Wollongong hearing, 14 April 2008, transcript 48.44.
- 295 Confidential Wollongong hearing, 14 April 2008, transcript 51.45-47.
- 296 Confidential Wollongong hearing, 14 April 2008, transcript 52.3-6.
- 297 Confidential Wollongong hearing, 14 April 2008, transcript 52.12-17.
- 298 Confidential Wollongong hearing, 14 April 2008, transcript 52.22-23.
- 299 Susan French, Coffs Harbour hearing, 27 March 2008, transcript 990.4-7.
- 300 Demaris Wickham, Nepean Hospital hearing, 8 April 2008, transcript 1390.9-20.
- 301 Demaris Wickham, Nepean Hospital hearing, 8 April 2008, transcript 1389.34-1390.7.
- 302 See the evidence of Rosalyn Ferguson, Hornsby hearing, 11 March 2008, transcript 223.45-225.24.
- 303 Submission of Charles Lawrie, Anne Clarke and Rosalyn Ferguson, undated, SUBM.010.0011 at 11.
- 304 Submission of Charles Lawrie, Anne Clarke and Rosalyn Ferguson, undated, SUBM.010.0011 at 11.
- 305 Submission of Charles Lawrie, Anne Clarke and Rosalyn Ferguson, undated, SUBM.010.0011 at 11.
- 306 Submission of Charles Lawrie, Anne Clarke and Rosalyn Ferguson, undated, SUBM.010.0011 at 12.
- 307 Rosalyn Ferguson, Hornsby hearing, 11 March 2008, transcript 223.45-47.
- 308 Rosalyn Ferguson, Hornsby hearing, 11 March 2008, transcript 224.2-13.
- 309 Letter from Professor Peter Castaldi, Greater Metropolitan Clinical Task Force, to Commissioner Garling, 7 March 2008.
- 310 NSW Health Briefing, 4 April 2008, transcript 71.8-15.
- 311 NSW Health Briefing, 4 April 2008, transcript 69.42-70.18.
- 312 NSW Health Briefing, 4 April 2008, transcript 101.16-19.
- 313 NSW Health Briefing, 4 April 2008, transcript 92.41-43.
- 314 NSW Health Briefing, 4 April 2008, transcript 92.43.
- 315 Meeting with Helen Bevan, National Health Service (United Kingdom), 14 March 2008.
- 316 Meeting with Helen Bevan, National Health Service (United Kingdom), 14 March 2008.
- 317 Meeting with Helen Bevan, National Health Service (United Kingdom), 14 March 2008.
- 318 Meeting with Helen Bevan, National Health Service (United Kingdom), 14 March 2008.
- 319 Confidential Armidale hearing, 26 March 2008, transcript 16.19-32.
- 320 Dr Gina Watkins, private Sydney Children's Hospital hearing, 19 May 2008.
- 321 Dr Gina Watkins, private Sydney Children's Hospital hearing, 19 May 2008.

-
- 322 Dr Gina Watkins, private Sydney Children's Hospital hearing, 19 May 2008.
- 323 NSW Health Briefing, 4 April 2008, transcript 90.32-35.
- 324 Phyllis Davis, Prince of Wales Hospital hearing, 1 May 2008, transcript 2519.10-11 and 2520.4-7.
- 325 Phyllis Davis, Prince of Wales Hospital hearing, 1 May 2008, transcript 2519.4-6.
- 326 Phyllis Davis, Prince of Wales Hospital hearing, 1 May 2008, transcript 2519.6-8.
- 327 Submission of NSW Operating Theatre Association, 1 October 2008, SUBM.102.0002 at 2.
- 328 Meeting with Brett Holmes, NSW Nurses' Association, 26 June 2008.
- 329 Confidential hearing at the Inquiry's offices via video-link from John Hunter Hospital, 30 May 2008, transcript 6.2-6.
- 330 David Smith, Tamworth hearing, 25 March 2008, transcript 792.35-43.
- 331 David Smith, Tamworth hearing, 25 March 2008, transcript 792.45-793.8.
- 332 Letter from Nurses & Midwives Board of NSW to Special Commission of Inquiry, 12 September 2008; Submission of the Australasian Nurse Practitioner Association, 27 March 2008, SUBM.007.0361 at 4; Letter from NSW Health to Special Commission of Inquiry, 4 September 2008.
- 333 NSW Health Briefing, 4 April 2008, transcript 88.31-39.
- 334 Professor Phillip Della, Experts' Conference, 15 September 2008, transcript 28.9-13, presentation slide 7.
- 335 Glenda Mullen, Sydney Children's Hospital hearing, 19 May 2008, transcript 3071.45-47 and 3072.21-20.
- 336 Glenda Mullen, Sydney Children's Hospital hearing, 19 May 2008, transcript 3072.25-30.
- 337 Information provided during visit to Shoalhaven District Memorial Hospital on 14 April 2008.
- 338 Information provided during visit to Shoalhaven District Memorial Hospital on 14 April 2008.
- 339 Information provided during visit to Wollongong Hospital on 14 April 2008.
- 340 Information provided during visit to Wollongong Hospital on 14 April 2008.
- 341 NSW Health Briefing, 4 April 2008, transcript 89.29-38.
- 342 NSW Health Briefing, 4 April 2008, transcript 89.45-47.
- 343 Information provided during visit to Mona Vale Hospital on 12 March 2008.
- 344 Information provided during visit to Mona Vale Hospital on 12 March 2008.
- 345 Submission of the Australian Nurse Practitioner Association, 27 March 2008, SUBM.007.0361 at 36.
- 346 Submission of the Australian Nurse Practitioner Association, 27 March 2008, SUBM.007.0361 at 36.
- 347 Submission of the Australian Nurse Practitioner Association, 27 March 2008, SUBM.007.0361 at 36.
- 348 Submission of the Australian Nurse Practitioner Association, 27 March 2008, SUBM.007.0361 at 36.
- 349 Submission of the Australian Nurse Practitioner Association, 27 March 2008, SUBM.007.0361 at 362.
- 350 Submission of the NSW College of Nursing, March 2008, SUBM.013.0073 at 3.
- 351 Submission of the NSW College of Nursing, March 2008, SUBM.013.0073 at 3.
- 352 Phillip Hungerford, Tamworth hearing, 25 March 2008, transcript 848.45-849.15.
- 353 Confidential Westmead Children's Hospital hearing, 15 May 2008, transcript 6.35-37.
- 354 Confidential Westmead Children's Hospital hearing, 15 May 2008, transcript 6.35-7.1.
- 355 Confidential Westmead Children's Hospital hearing, 15 May 2008, transcript 7.2-6.
- 356 Submission of Michael Golding on behalf of the specialist emergency medicine consultants at Sutherland Hospital, undated, SUBM.023.0202 at 3.

- 357 Submission of Michael Golding on behalf of the specialist emergency medicine consultants at Sutherland Hospital, undated, SUBM.023.0202 at 3.
- 358 Submission of Michael Golding on behalf of the specialist emergency medicine consultants at Sutherland Hospital, undated, SUBM.023.0202 at 3.
- 359 Information provided during visit to Quirindi Hospital on 25 March 2008.
- 360 Meeting with Dr Tony Joseph, Australasian College of Emergency Medicine, 27 June 2008.
- 361 Submission of Australasian College for Emergency Medicine, March 2008, SUBM.027.0007 at 29.
- 362 Meeting with Dr Sally McArthy, Australasian College for Emergency Medicine, 27 June 2008.
- 363 Meeting with Australian Salaried Medical Officers Federation, 23 June 2008.
- 364 Meeting with Australian Salaried Medical Officers Federation, 23 June 2008.
- 365 Submission of Australian Medical Association (NSW) Limited and Australian Salaried Medical Officers' Federation, 28 March 2008, SUBM.016.0015 at 41.
- 366 Confidential submission, 28 March 2008, SUBM.014.0092 at 10.
- 367 Confidential submission, 28 March 2008, SUBM.014.0092 at 10.
- 368 Submission of Dr Andrew Hooper, 30 March 2008, SUBM.008.0017 at 5-6.
- 369 Glenda Mullen, Sydney Children's Hospital hearing, 19 May 2008, transcript 3071.1-5.
- 370 Glenda Mullen, Sydney Children's Hospital hearing, 19 May 2008, transcript 3073.19-26.
- 371 Glenda Mullen, Sydney Children's Hospital hearing, 19 May 2008, transcript 3073.26-36.

9 Allied Health & Pharmacy

Allied health	290
Allied health professionals and training	290
Importance of allied health in NSW public hospitals	292
Extended role of allied health	293
Lack of allied health professionals	294
Consequences of lack of allied health professionals and services	295
Factors contributing to lack of allied health professionals and services.....	297
Allied health assistants	300
Lack of career structure	300
Grades and remuneration for most allied health professionals	300
Grades and remuneration for pharmacists	301
Grades and remuneration for psychologists.....	301
Ineffective representation at management level	302
State level	302
Area health service level	302
Hospital level	302
Pharmacy	303
Clinical Pharmacy Review	304
Recruitment challenges due to pay disparity.....	306
Discharge medications	308

- 9.1 In this chapter, I examine the problems faced by allied health professionals working in NSW public hospitals. In the latter part of this chapter I examine some specific problems faced by pharmacists who work in hospitals in NSW.
- 9.2 Elsewhere in this report, I have considered other issues faced by allied health professionals in NSW:
- (a) the lack of allied health professionals in rural areas in Chapter 6;
 - (b) continuing education and training of allied health professionals in Chapter 10;
 - (c) lack of support services in Chapter 11; and
 - (d) communication with other health professionals in Chapter 15.

Allied health

- 9.3 I was most surprised to find that allied health professionals are considered the second-class citizens of the health sector.
- 9.4 While the roles of doctors and nurses are well recognised in hospitals, patients also receive a significant amount of treatment from a mix of health care professionals.

Allied health professionals and training

- 9.5 Allied health is the term broadly used to categorize the professionals who apply their knowledge and skills to restoring and maintaining the patients' optimal physical, sensory, psychological, cognitive or social functions.¹ Whilst there may be some debate as to whether a particular profession falls within the description of 'allied health',² the following professionals are generally accepted as being encompassed within that term: audiologists, dieticians and nutritionists, occupational therapists, orthoptists, orthotists and prosthetists, hospital pharmacists, physiotherapists, podiatrists, psychologists, radiographers, speech pathologists and social workers.³
- 9.6 Certainly, many of these professionals experience similar difficulties in working in the NSW health system. Pharmacists have some additional unique concerns, which I have discussed later in this chapter.
- 9.7 A brief description of the groups of professionals whose numbers dominate the allied health workforce in NSW public hospitals is set out in Table 9.1. I have omitted radiographers from Table 1, because their role is linked to radiologists and medical imaging. I deal with them in my discussion of Pathology & Medical Imaging in Chapter 24.
- 9.8 The various boards, societies and associations that govern the professions largely dictate the academic and training criteria for registration, membership or accreditation of allied health professionals. There is a general lack of consistency throughout Australia and between the professions, with different states requiring either registration, or membership, to permit individuals to practice. In NSW, physiotherapy, podiatry, psychology and pharmacy are the only allied health professions requiring registration to practice. The minimum standards which are required for employment in NSW Health as outlined in the various awards are also shown in Table 9.1.⁴

Table 9.1 Allied health professional groups

	Role	Training
Physiotherapists	<p>assess and treat people with physical problems related to injury, illness, diseases and aging.</p> <p>The types of treatments include mobilisation, manipulation of joints, massage, therapeutic exercise, electrotherapy and hydrotherapy. They also deliver patient education and help people avoid injuries and maintain a fit, healthy body.⁵</p>	<p>must hold a degree in physiotherapy or applied science (physiotherapy) and be registered with the NSW Physiotherapists Registration Board as constituted by the <i>Physiotherapists Act 2001</i>.⁶</p>
Occupational therapists	<p>work with people with a variety of conditions caused by injury, psychological or emotional illness, developmental delay and the effects of aging.</p> <p>Occupational therapists assist in developing and maintaining people's skills to carry out their everyday occupations such as work/school, self-care, leisure and play.⁷</p>	<p>must hold a degree in health sciences or applied science specialising in occupational therapy, which provides eligibility for membership in the Australian Association of Occupational Therapists, or other qualification deemed equivalent by the employer.</p>
Speech pathologists	<p>assess, diagnose, treat and manage services for people who have impairments in their ability to communicate such as, the ability to use speech, use and understand language, hear, read or write.</p> <p>Speech pathologists also work with patients who have difficulties swallowing food or drink.⁸</p>	<p>must hold a bachelor or post graduate degree in speech pathology and be eligible for full membership of Speech Pathology Australia, or other qualification deemed equivalent by the employer.</p>
Dieticians	<p>provide expert advice on food and nutrition and have the clinical training to modify diets for the treatment of conditions such as diabetes, heart disease, cancers, gastro-intestinal diseases, food allergies and intolerances.⁹</p>	<p>must hold a bachelor or postgraduate degree in nutrition and dietetics that provides eligibility for full membership of the Dieticians Association of Australia or other qualification deemed equivalent by the employer.</p>
Psychologists	<p>specialise in the study of human behaviour, personality, interpersonal relationships, learning and motivation.</p> <p>Psychologists provide assessments, psychological interventions and counselling and advise on appropriate treatments for the patient's mental health needs.¹⁰</p>	<p>must be registered with the NSW Psychologist Registration Board as constituted under the <i>Psychologists Act 2001</i>.</p> <p>For registration as a psychologist, a person must have completed a 4 year degree in psychology, being a three year degree with a 4th year honours in psychology; or who has qualifications deemed equivalent by the Health Administration Corporation of New South Wales and had 2 years of practical experience.¹¹</p>

	Role	Training
Social workers	<p>assess and counsel people who have suffered trauma and chronic illness and identify factors that may impact upon the patients' recovery.</p> <p>Social workers also provide information and emotional and practical support to patients and their families to assist them in solving problems in their relationships.¹²</p>	<p>must hold a bachelor degree in social work, which provides eligibility for membership of the Australian Association of Social Workers, or other qualification deemed equivalent by the employer.</p>
Hospital pharmacists	<p>are experts in medicines. Pharmacists review the patient's medicines, monitor their progress and make sure that they understand how to take their medicines correctly.</p> <p>Pharmacists may also assist in determining the appropriate forms and doses of medicine.¹³</p>	<p>must have either a Diploma of Hospital Pharmacy, Diploma of Clinical Pharmacy or any other postgraduate qualification in pharmacy, and a minimum of 6 months experience in the relevant speciality, or other qualifications and experience as required by the award.¹⁴</p>

Importance of allied health in NSW public hospitals

- 9.9 Allied health professionals provide essential health services for patients in NSW public hospitals. Here are some examples:
- (a) In the community they can reduce hospital admissions through health promotion, managing disability and disease and improving long-term health outcomes for patients.¹⁵ NSW Health has acknowledged the important role which allied health plays in "optimising quality of life, degree of independence, and preventing risk of further problems."¹⁶

"Burn Rubber Burn" is an example of a programme that was developed by allied health professionals to keep people with specific illnesses and spinal chord injuries, fit and out of hospital.¹⁷ The programme is a circuit based exercise class involving a series of exercises to develop upper body strength. The trial program commenced in 2005-06 with 32 participants and funding by the Greater Metropolitan Clinical Taskforce. All participants in the program reported significant or fair improvement in their fitness. The programme can be found in Police & Community Youth Clubs in Pagewood, Minto, Sutherland and soon to be in Penrith.

- (b) They provide patient care before, during and after hip replacement surgery.

Physiotherapists contributed to the success of the mini-invasive procedure for hip joint replacement at the Sir Charles Gairdner Hospital in Western Australia. Physiotherapists there were involved with the preoperative assessment, education and physical conditioning, immediate postoperative management and longer-term rehabilitation of patients undergoing major hip surgery. Patients expressed great satisfaction with the program and reported less pain. A standard hip replacement procedure had a hospital stay of 14 days with 30% of patients being able to stand on the 1st post-operative day. Under the accelerated program, the average hospital stay is 5 days and 98% of patients are standing on the 1st post-operative day.¹⁸

- (c) They help patients recover post operatively, and help reduce hospital stays.¹⁹

The positive impact of allied health services in the treatment of stroke victims was recognised in the establishment of the National Clinical Guidelines for acute stroke management. The guidelines establish protocols for the triage, diagnosis and treatment of stroke patients so that the most appropriate treatment is commenced and the most appropriate services engaged. Under the guidelines, all patients are screened to determine their clinical condition and, if required, referred to a speech pathologist for a swallowing test. Should the patient not be assessed for their ability to swallow and they consume any food or drink, they are at risk of contracting aspiration pneumonia. The rates of aspiration pneumonia was reduced from 26% to 4% in stroke patients. The length of hospital stay of patients with severe stroke was reduced from 30.3 days in 2004 to 16.4 days in 2007.²⁰

- 9.10 Other professionals recognise the importance of early intervention and involvement of allied health staff as being crucial for good patient management. I was told that allied health professionals, when used as part of a multi-disciplinary team, early in the patient's stay in hospital, assist in the determination of a discharge date for the patient and facilitate a smooth patient journey.²¹ I was also told:²²

"[E]arly identification and referral to either occupational therapy or social work or physio is absolutely crucial for good patient management and early discharge planning."

They also recognise the importance of specialised allied health services that can extend beyond the medical model of care. For example, one witness said:

"Allied health is a large part of paediatric care, partly because [with] particularly complex patients, their whole interaction with their schooling and their families and their growing and development is such an important part."²³

Extended role of allied health

- 9.11 I envisage that allied health professionals will have an increasing role to play in the future. The range of services and depth of skills and training that allied health professionals have make them the ideal pool of staff to expand into other areas of patient care.
- 9.12 I have heard of several ways in which allied health have been used in expanded roles. For example, physiotherapists have been successfully incorporated into the Accident & Emergency Departments at Liverpool and St Vincent's Hospitals. The physiotherapist is involved in assessment and treatment and can refer orthopaedic patients to a consultant as necessary, "resulting in a quicker treatment time for these patients."²⁴
- 9.13 I have also had suggested to me that physiotherapists with specialist training may be used in triage to assist in the early assessment and treatment of the lower category patients that do not require extended waits in Accident & Emergency.²⁵ I have also heard of the benefits of having primary care roles for physiotherapists and the introduction of physiotherapy practitioners in the United Kingdom.²⁶
- 9.14 Part of recognising the importance of allied health is the realisation that rehabilitation of a patient should commence at the beginning of a clinical episode and not be a 'bolt on' after the usual clinical options have concluded.²⁷ There has been significant research throughout Australia and internationally into the value of extension of traditional allied health roles and the early implementation of appropriate treatments for acutely unwell

patients.²⁸ Alternative treatments were suggested that may prove to be cost effective and improve patient mortality rates. For example, non-invasive ventilation and its role in reversing acute hypercapnic respiratory failure.²⁹

- 9.15 Stroke Services NSW provides an excellent example of the scope for a greater use of allied health clinicians in broader multidisciplinary teams and demonstrates how clearly defined roles can lead to greater patient care and a more efficient use of acute care services.³⁰
- 9.16 Allied health professionals are also likely to play an important part in the treatment of elderly patients who, as I have discussed in Chapters 2 and 3, are going to become an increasingly important group of patients in hospitals in the coming years. The elderly have increasingly complex co-morbidities and it is essential that there are sufficient allied health staff to manage the patient's care both in and after hospital.³¹
- 9.17 However, to my observation, although only in its policies, NSW Health recognises the value of allied health professionals, in practice, often under budgetary pressure, their professional contributions are treated as optional and, unfortunately, dispensable.

Lack of allied health professionals

- 9.18 I heard evidence in my Inquiry that there was often a lack of allied health services on the wards in NSW hospitals.
- 9.19 Allied health professionals represent almost 14% of the clinical health workforce in NSW public hospitals. They represent a slightly smaller proportion of the workforce than doctors.³²
- 9.20 As I indicated earlier, not all allied health professionals are required by their individual governing bodies to register. This makes it difficult to obtain precise statistics on the workforce numbers.³³ The data below from NSW Health³⁴ indicates that, overall, there has been an 11.7% increase in the full time equivalent numbers for all of the main categories of allied health professionals employed in public hospitals from June 2004 to June 2007. The exception is orthotists/prosthetists, whose numbers decreased 2.8%.

Table 9.2 Full Time Equivalent (FTE) Allied and other Professional Health Staff

	Jun-04	Jun-07	Diff	%Diff
Audiologist	21.2	21.3	0.1	0.5%
Clinical Psychologist	431.8	513.8	82.0	19.0%
Dietitian	353.1	415.6	62.5	17.7%
Occupational Therapist	852.9	952.9	100.0	11.7%
Orthoptist	18.7	24.0	5.3	28.3%
Orthotist / Prosthetist	29.7	28.8	-0.8	-2.8%
Pharmacist	445.8	554.7	108.8	24.4%
Physiotherapist	991.2	1,099.5	108.3	10.9%
Podiatrist	47.1	57.2	10.2	21.6%
Psychologist	476.6	495.5	18.9	4.0%
Social Worker	1'193.0	1,297.1	104.1	8.7%
Speech Pathologist	433.2	454.9	21.7	5.0%
Sub Total	5294.4	5915.4	621.0	11.7%

- 9.21 The significant question is whether the size of the workforce is sufficient. I cannot compare the number of allied health professionals employed in NSW public hospitals with any standards or guidelines for the numbers of allied health professionals that there **should** be. There are no available figures on the required staffing levels for allied health services for a particular patient population or hospital size. There is no clear understanding of the required number of allied health professionals to provide a particular service.³⁵
- 9.22 In 2006, clinicians from the Greater Metropolitan Clinical Taskforce conducted a study to review the minimum medical and allied health staffing and skill levels required for a particular sized hospital facility. Whilst the study resulted in some figures being proposed for the required staffing levels, it did not provide information that can be applied to the large range of hospital sizes and patient demographics that exist throughout NSW. The report concluded that additional study needs to be made to provide worthwhile consistent data on the staffing levels of allied health professionals.³⁶ However to date, no further study has been conducted to assist in workforce planning of allied health staff.³⁷
- 9.23 What I can say, is that I heard a considerable amount of consistent evidence from doctors, nurses, allied health professionals, patients and their carers, which reported a lack of allied health professionals working in NSW public hospitals.
- 9.24 As usual, the lack of allied health professionals was more acute in rural and remote areas. I have discussed this in Chapter 6. However, the problem is not isolated to rural and remote locations. For example, I heard that at the Children's Hospital, Westmead that Accident & Emergency does not have a play therapist, pharmacist or physiotherapist for plasters.³⁸
- 9.25 The shortage of allied health professionals in NSW public hospitals does not necessarily reflect a shortage of appropriately trained professionals for each area of allied health practice. Data on the Australian workforce indicates that there is no shortage of qualified and trained dietitians in New South Wales.³⁹ The main professions that have the greatest vacancies or unfilled positions are: speech pathologists, occupational therapists, physiotherapists and hospital pharmacists.⁴⁰ In respect of speech pathologists,
- "...about one fifth of employers surveyed did not receive any response to their advertisements."⁴¹
- 9.26 The lack of allied health services in NSW public hospitals can not be seen to be solely attributable to a failure by NSW Health to create sufficient positions within its organisational structure and recruit to those positions. Other issues such as pay and conditions of work may also be seen to have causal effect.

Consequences of lack of allied health professionals and services

- 9.27 The lack of allied health professionals has several consequences.
- (a) Length of stay increases when allied health services are not available and patients miss out on the benefit of timely treatment by allied health staff:
- "Some patients are seen every second day instead of daily delaying their discharge, other patients wait for assessment and treatment, prolonging their disability."⁴²
- "Patients waiting for extended periods for care may be losing the benefits of early intervention and treatment, before their condition becomes chronic."⁴³

"I believe that it actually delays patient discharges (thus increasing health care costs) and in some cases, may lead to patients being missed entirely (thus risking untimely re-admission to hospital)."⁴⁴

I heard that patients in Mudgee rely on the services of the occupational therapist from Dubbo and that the waiting time for this service may be up to four weeks.⁴⁵ Some of these patients are referred to Dubbo, or discharged home whilst awaiting treatment, despite the potential safety risks of this bandaid solution. Some wait in hospital or sometimes Mudgee Health Service contracts a private occupational therapist to conduct the required assessments.⁴⁶

- (b) Allied health professionals have to prioritise which patients receive allied health services.

"[T]he people who usually miss out are the patients. It is basically crisis management. We don't see routinely, diabetes, weight reduction or cardiology patients; we're just seeing acutely ill patients."⁴⁷

This causes additional frustration and stress.⁴⁸

"It is not about the money, it is not about overtime, it is just that we cannot see the people that need to be seen, and it is really frustrating."⁴⁹

- (c) When allied health departments are short staffed, extra strain results for the remaining staff.⁵⁰ Staff feel the pressure of trying to maintain the same level of service despite staff shortages.⁵¹
- (d) Instead of the appropriate allied health professional, it is the nursing staff who have to make assessments about the patient's need for various types of treatment.

"You might have 20 patients who need a physiotherapist, but you can only fit in five patients because of your priority list. These issues are more and more taking the nurse unit managers away from the clinical management of their wards and the patient care."⁵²

- (e) Nurses bear a greater burden to complete some of the tasks of allied health professionals; such as when there is no social worker or dietician available.⁵³ Social workers are specifically trained to provide emotional support to families in distress and help them through traumatic situations.⁵⁴ Nurses are not necessarily trained or equipped to cope with these situations and may find it difficult to manage, professionally and personally.
- (f) Understaffing makes it almost impossible for allied health professionals to participate in research, quality assurance projects or improving clinical protocols.⁵⁵

"The present situation for allied health is that clinical practice is being impeded by limited capacity to implement evidence based practice, undertake continuous quality improvement and clinical research."⁵⁶

- 9.28 In my view, it is necessary for all professionals to continue developing their skills and remain current with research developments that affect the safety and quality of their work.

Factors contributing to lack of allied health professionals and services

- 9.29 There are a number of specific factors contributing to the lack of allied health professionals available to provide services in NSW hospitals.

No backfilling

- 9.30 In what appears to be a budgetary measure, allied health professionals are not 'backfilled', or replaced, when they are on paid leave, be it sick leave, maternity leave, annual leave or the like. During a hearing, one witness said that there is a shortage of allied health staff and delays of 2 to 3 days before they will see patients. Allied health staff are sometimes on leave and are not back filled. This can add 2 to 3 days to patients' lengths of stay.⁵⁷
- 9.31 Whilst temporary absences due to sickness or unexpected leave cannot always be filled, maternity, annual and long service leave are generally taken with a reasonable amount of notice.
- (a) The award governing leave entitlements and conditions for hospital employees dictates that the employer is to give the employee not less than one month's notice of when leave is going to be taken.⁵⁸
 - (b) Long service leave is taken at a time mutually arranged between the employer and employee, and terminations of employment (after 3 months of continuous service) require 28 days notice, or payment of equivalent salary.⁵⁹
 - (c) When taking maternity leave, staff are obliged to give written notice to their employer no less than 8 weeks prior to the commencement of leave and provide a medical certificate containing the expected date of birth.⁶⁰

Based on these requirements, it would appear that management would receive ample warning to backfill staff who are going to be absent for extended periods.

- 9.32 I was disturbed to hear, from many witnesses, that these potentially long term absences were not being filled.⁶¹

"...we experience absolutely no relief for staffing, for ADOs, for sick leave or annual leave, maternity leave or study leave."⁶²

- 9.33 As the allied health departments are often small, they do not have budgetary capacity to pay the high rates for locums. This means that the hospital may be without the services of, or adequate cover for, allied health staff for long periods of time.

"We don't have access to agency staff or the budgets to pay three times the rate for a locum or anything like that, so normally when allied health staff go on leave or are sick, their patients just wait. So if a vacancy is left for six months or twelve months, that's just the way it is."⁶³

- 9.34 Staffing levels are determined according to patient need⁶⁴ and long term loss of staff "means that the quality of care is compromised and there is a loss of continuity of care".⁶⁵ For example, I heard evidence at one of my hearings about 5 pharmacists being absent, either on leave or sick, on the morning of the hearing. As usual, the pharmacists were not replaced with the result that patients' medication charts were not checked. I was told that on several occasions pharmacists have reduced medication incidents and exposed errors in the dosages of medications through the routine checking of medication charts.⁶⁶

"That has saved children's lives because they have been up there on the ward and have been able to see when a child has been prescribed five times the dose of medication."⁶⁷

- 9.35 NSW Health has a policy governing the timely replacement of nursing staff who are going to transfer, resign or have their employment terminated, or are yet to commence duties. This includes staff who are commencing extended periods of leave such as maternity and long service leave. The directive includes a number of processes to ensure a smooth staff transition.⁶⁸
- 9.36 There is no such policy for allied health staff in NSW public hospitals.
- 9.37 It is unacceptable to me that staff whose role is critical in the treatment, care and safety of patients are not replaced when they are on leave or absent from work for extended periods.

Not rostered after hours

- 9.38 Hospitals provide services 24 hours a day, 7 days a week. Demand for all medical services exists beyond the normal business hours of Monday to Friday, 9 to 5.
- 9.39 Health professionals complained that there is virtually no allied health services available after hours or on weekends.⁶⁹ I also heard that even when some level of allied health service is provided in larger hospitals, there is no funding for senior allied health staff to be on call after hours.⁷⁰ This has a major impact on patients.⁷¹
- 9.40 This means that for example, a frail elderly patient ready to be discharged from the hospital on Saturday, but needing mobility tests from a physiotherapist before discharge, may have to stay in hospital until Monday to receive that service. This is false economy.
- 9.41 Many of the treatments by allied health professions are therapeutic in function, and need to occur consistently to be effective. There is significant research that indicates that therapeutic treatment should happen on a regular basis with a high degree of intensity.⁷² This cannot happen if allied health staff are unavailable after hours or on weekends. The advantages of maintaining continuous treatment capability would assist in reducing the incidence of patients waiting for treatment, delays in discharging patients, and delaying the patient's progression onto their next course of treatment.⁷³ It would also mean that patients get better more quickly.
- 9.42 The 2 areas in which there has been some effort and attention to providing after hour 24 hour support of allied health services are in medical imaging (discussed in Chapter 24) and the use of physiotherapists in Accident & Emergency, referred to above.

Not factored into increases in clinical services

- 9.43 I was told that, when a hospital opens a new ward or offers a new service to the community, the consequential increase in demand for allied health services is not matched by an increase in the numbers of allied health professionals employed by the hospital.⁷⁴ For example, the new hospital at Coffs Harbour has brought with it a large increase in the services provided, but not a corresponding increase in pharmacist staff.⁷⁵
- 9.44 Whilst there may be some areas where increases in technology and new treatments may speed up the treatment and shorten the length of stay of patients, therapeutic treatments require a consistent level of time allocated to each patient and staff levels to

match. I heard at one hospital that over the last 15 to 20 years, the workload has increased dramatically, whereas the staffing levels of dieticians has been cut by 25 to 30%.⁷⁶

- 9.45 The establishment of Medical Assessment Units throughout NSW utilise the skills of doctors, nurses, physiotherapists and social workers. I was concerned to hear that the establishment of these units has not always been matched by an increase in allied health staff to staff these units.⁷⁷

"...the other resources get put into place first and then it is how much money is left over for allied health. It would be great to see, when funding is allocated, some specific amount at the point of allocation to be directed to allied health services so that we are an integral part of the treatment plan and not a luxury."⁷⁸

- 9.46 I have been told that new models of care have been introduced without matching increases in allied health staffing. The current staffing levels of allied health professionals do not allow for implementation of the National Guidelines for Acute Stroke management in some centres, despite the proven positive effect of such programs.⁷⁹ I was concerned to learn that at Wollongong Hospital, patients may have to wait up to 2½ hours for a swallowing assessment by a speech pathologist due to inadequate staffing.⁸⁰ The Guidelines state that such an assessment is to be made before the patient can consume any food or liquid. As discussed above, stroke patients can suffer from aspiration pneumonia if they are unable to swallow properly.

- 9.47 I also heard of the difficulties with the implementation of the NSW Health Long Wait List Programme, 2005 and the additional funding to reduce surgery waiting times which failed to plan for the increases in allied health services to meet the inevitable demand that this programme caused downstream.

"None of the Physiotherapy Departments affected by the Long Wait-List programme reported any specific enhancements in physiotherapy services which would allow them to comfortably increase their service provision in the face of the increase in demand."⁸¹

- 9.48 For some allied health professionals, the success of this well-intentioned program is unfortunately marred by its failure to recognise the contribution of allied health professionals and allocate resources accordingly.⁸²

Additional restrictions on recruitment

- 9.49 Whilst allied health professionals experience the same frustrations as other health professionals when recruiting staff, allied health faces the further obstacle that all existing⁸³ and proposed positions must be approved by senior management or the chief executive of the area health services.⁸⁴ This adds additional delays to the already lengthy recruitment process in circumstances where there is no 'backfilling'. During my Inquiry, one witness said:

"And if you don't have access to any way of backfilling, it creates a service issue that goes across the department."⁸⁵

- 9.50 I heard at Coffs Harbour that only 30% of the pharmacists are permanent and that they have had vacant positions since 2004 waiting to be signed off by the chief executive. During the hearing at Coffs Harbour, one witness said:

"[W]hat we're doing is we're paying locums, we're paying locum agencies, we're paying accommodation costs. It's

actually costing us a lot more money and they don't stay."⁸⁶

- 9.51 I also heard that this problem is compounded by the failure in some instances to advertise positions in a timely and appropriate way to attract staff.⁸⁷ I was told that some management positions have been regularly vacant for up to a year.⁸⁸
- 9.52 Short staffing, failure to replace staff on leave, and delays in employment procedures appear to be a means of saving money in the health budget. The false economy that these "savings" have is compromising patient safety, treatment and rehabilitation, and staff satisfaction and retention.

Allied health assistants

- 9.53 Part of a solution for the lack of allied health professionals may be the expanded use of allied health assistants.
- 9.54 For a number of years, there have been allied health aides and therapy assistants who have provided assistance to allied health professionals. The Industry Skills Council now offers courses for Certificate IV in Allied Health Assistance and Certificate III in Health Service Assistance (Allied Health Assistance). The Certificate IV course allows for specialisation in particular skills areas, for example physiotherapy and occupational therapy. The Certificate III course provides a more general education with electives offered for particular allied health fields.
- 9.55 The increased use of such roles to assist allied health staff could assist in providing directed assistance to allied health staff in their duties and may also encourage some of the participants to undertake additional studies to become fully trained professionals. I was told that physiotherapy assistants with a certificate IV provide a greater level of support and are more useful in the clinical setting than the physiotherapist aides who were unqualified.⁸⁹
- 9.56 Allied health assistants should not be considered a complete alternative to allied health professionals as a means of saving money.⁹⁰ Allied health assistants must be supervised by allied health professionals and do not have the required level of training or expertise to provide the full range of services of the fully trained allied health professionals.⁹¹ However, such assistants are a readily available and cost effective way to supplement the allied health services being provided.

Lack of career structure

- 9.57 I heard that allied health professionals have limited opportunities to develop their careers. I received many submissions that called for the creation of more senior allied health positions and, particularly, the creation of the position of clinical allied health consultant, similar to that of the clinical nurse consultant.⁹² Some also called for greater incentives for allied health staff to develop their skills to remain in the workforce, a more developed career structure and greater flexibility in work hours.⁹³

Grades and remuneration for most allied health professionals

- 9.58 The creation of the NSW Health Service Health Professionals (State) Award ("**Health Professionals Award**") on 30 November 2007⁹⁴ consolidated the 18 different classifications under the various awards that applied to those allied health professionals immediately prior. It does not however apply to pharmacists or psychologists.⁹⁵ The

Health Professionals Award contains a regime for promotion through 8 stages and prescribes minimum wage rates which vary according to the allied health professional's status. This new award is said to "provide an improved career structure".⁹⁶

- 9.59 As at the date of writing this report, the minimum wage rates under the Health Professionals Award range from \$46,089 to \$118, 093.⁹⁷
- 9.60 As the Health Professionals Award has only been in place for a short period of time, it is not possible to meaningfully assess the extent of the benefits it may yield, if any. I have not heard of any substantial improvements to the career paths of allied health professionals since its introduction.
- 9.61 As of June 2008, there were only 36.6 Level 4 and 11.5 Level 5 FTE allied health professionals employed under the Health Professionals Award. Of these, 24.6 and 5.8 respectively were employed at the Children's Hospital at Westmead. These positions include department heads, deputy department heads, unit or team leaders and professional educators.

Grades and remuneration for pharmacists

- 9.62 The NSW *Health Employees' Pharmacists (State) Award* ("**Pharmacists Award**") prescribes the minimum entitlements for a pharmacist employed by NSW Health. Under the Pharmacists Award, the minimum starting salary is \$50,596 for a registered pharmacist and ranges up to \$117,249.60 for a director of a pharmacy in a major hospital.⁹⁸
- 9.63 Registered pharmacists commence at grade 1 or 2 depending on their experience. Grades 3 to 7 are for senior pharmacists, directors of pharmacy and deputy directors of pharmacy with the size of the hospital dictating the level that the pharmacist can obtain. Currently there is no grading for a specialist clinical pharmacists after the pharmacist has progressed through grades 1 and 2, or any recognition for developing advanced skills without progressing into a management positions.⁹⁹

Grades and remuneration for psychologists

- 9.64 Psychologists registered under the *Psychologists Act 2001* (NSW) eligible for registration commence at a salary of \$53,948 and progress up to \$82,896 for a senior psychologist in their third year of service. Clinical psychologists commence on \$69,739 and progress up to \$107,896 for a principal clinical psychologist.¹⁰⁰
- 9.65 Psychologists can progress to the position of senior psychologist or can undertake additional training to become a clinical psychologist. A clinical psychologist can progress to the level of a senior clinical psychologist and eventually principal clinical psychologist. Psychologists are remunerated according to their length of service. After achieving these stages there are no further opportunities for career advancement.

Recommendation 26: *I recommend that NSW Health address deficiencies in the workforce of and delivery of services by allied health professionals in public hospitals by considering and implementing a program which addresses the following matters:*

- (a) *The institution of policies which mandate timely action for dealing with vacancies of allied health professionals so as to ensure that replacements occur when allied health staff are on annual leave,*

maternity leave or long service leave or any other period of leave which exceeds 5 working days;

- (b) Enhancing allied health services in hospitals by providing for allied health staff either to be rostered for at least two shifts a day and to be on call for a third shift or else taking other steps to ensure that there is available an adequate supply of allied health services to inpatients on all 7 days of the week;*
- (c) Ensuring that when new models of care are introduced which require input by allied health professionals that the appropriate contribution by those allied health professionals is sought, recognised and incorporated into the model of care. It will be necessary to ensure adequate funding for such allied health participation;*
- (d) Determining the appropriate means by which allied health professionals should receive adequate ongoing education and providing such education and training.*

Ineffective representation at management level

State level

- 9.66 Allied health professionals are represented at NSW Health by the Chief Allied Health Officer who is immediately accountable to the Director of Workforce Development and Leadership. Workforce Development and Leadership is part of the Health System Support Branch.¹⁰¹

Area health service level

- 9.67 I was told that each of the area health services now has an Allied Health Advisor and 2 discipline specific advisors responsible to the Chief Allied Health Officer.¹⁰²
- 9.68 The Allied Health Advisors in the area health services are also responsible to the Director, or Manager, of Clinical Operations, or the Director of Workforce Development, at the area health service level.¹⁰³

Hospital level

- 9.69 However, at the local hospital level, the management of allied health services has long been recognised as a problem.¹⁰⁴ In hospitals, the numbers of allied health staff by individual profession may represent a small fraction of the overall health workforce. The breadth of the range of services provided by allied health and the lack of any formalised commonality between the professions results in some allied health professionals being marginalised and largely ignored in hospital management structures.
- 9.70 Within hospital management I was told that, unlike doctors and nurses, allied health professionals are commonly not represented on boards or committees and struggle to have strong lines of communication with hospital management. For example, one witness said:

"Lines of professional accountability vary and structural arrangements can mean clinicians are not being managed by a team/leader/manager that can account for their professional responsibilities."¹⁰⁵

- 9.71 This has led some to question the appropriateness of having allied health managed by doctors and nurses as they do not necessarily understand allied health staffing issues and they therefore do not achieve “optimum patient outcomes”.¹⁰⁶
- 9.72 For example, at the Royal North Shore Hospital, the Physiotherapy Department is managed under the Division of Surgery and Anaesthesia.¹⁰⁷ The other allied health services that form the majority of the workforce at this hospital are divided between the Division of Medicine and Aged Care (nutrition/dietetics department, pharmacy services, and speech therapy department) and the division of women’s children’s and family health (occupational therapy and social work department). There is no uniformity in the categorisation and lines of responsibility in allied health services within the other hospitals in the Northern Sydney Central Coast area health service.¹⁰⁸
- 9.73 As mentioned above, the combined workforce of allied health professionals represents about the same proportion of the health workforce in hospitals as doctors. But the absence of any leadership at the hospital level and the dispersal of various allied health professions amongst other departments denies the possibility of having a combined voice. It is apparent to me that allied health professionals require a representative as part of the executive committee at hospital level to be involved in:
- determining the appropriate staffing levels, the employment of staff and filling of existing positions;
 - enhancing communication between professions;
 - defining the roles, duties and responsibilities of each profession; and
 - ensuring that staff engage in appropriate continuing education and ensure best practice initiatives are implemented.
- 9.74 Whilst some larger hospitals have sufficient staffing levels to support discipline specific manager positions,¹⁰⁹ it is essential that all hospitals have a representative in the hospital management who will represent the range of allied health professions.¹¹⁰
- 9.75 A director of allied health would help promote the provision of allied health services in hospitals and ensure that all members of the allied health staff receive the necessary support to maximise patient care. I note that in the structure at the Children’s Hospital in Westmead, all of the allied health professionals are grouped together (with the exception of the allied health staff involved in diagnostics). Allied health is recognised as one of the clinical programs.

Recommendation 27: *A director or co-ordinator of allied health services be appointed in each hospital or hospital facility. That person should be a senior allied health practitioner with knowledge of the range of all allied health roles.*

Pharmacy

- 9.76 During the course of my Inquiry, some important issues were raised by hospital pharmacists, which warrant separate treatment.
- 9.77 The role of hospital pharmacists is to provide clinical pharmacy services including:
- (a) taking medication histories from patients and, where possible, verifying the history against another source;¹¹¹
 - (b) participating in ward rounds;

- (c) giving medication advice to patients;
 - (d) giving advice, outside ward rounds, about the appropriateness of medications for the clinical condition of the patient, particularly to junior doctors and nurses;¹¹²
 - (e) adverse drug reaction management;
 - (f) dispensing of, and distribution to patients and wards of medication; and
 - (g) for specialists in areas such as psychiatry and cancer treatment, participation in clinical trials of new medications.
- 9.78 A recent study of 95 hospital pharmacy services shows that a hospital pharmacist's time in New South Wales is spent, on average, 35% in dispensing medications, 45% in clinical pharmacy services and the balance in management tasks.¹¹³
- 9.79 Medication errors in hospitals are quite common and can cause death, and injury. In its half-yearly reports on incidents in the NSW Health System, the Clinical Excellence Commission recorded 20,919 medication or intravenous fluid incidents in NSW public hospitals in 2007.¹¹⁴

Clinical Pharmacy Review

- 9.80 Many studies show that a pharmacist's taking of patient medication history or carrying out a patient chart review assists the other practitioners,¹¹⁵ reduces medication errors,¹¹⁶ which can help reduce the patient's stay¹¹⁷ and in turn, save the hospital money¹¹⁸ and free up beds.¹¹⁹ This is especially relevant to geriatric patients who have proven more likely to be susceptible to medication error.¹²⁰ Reports into improving medication safety also show associated cost benefits.¹²¹ The former Australian Council for Safety and Quality in Health Care said:
- "Clinical pharmacy services ... can support systems to reduce medication incidents, through patient and staff education, monitoring and medication review."¹²²
- "... it is estimated that around 140,000 hospital admissions each year are associated with problems with the use of medicines ... inappropriate use of medicines in Australia costing approximately \$380 million per year in the public hospital system alone."¹²³
- 9.81 It became apparent to me that hospital pharmacists are heavily relied on in hospital wards to review patients and patient charts for medication errors¹²⁴ or potential adverse drug reactions, provide patients with education on their prescribed medications, and provide a resource to junior doctors and nurses on the best use of medicines.
- 9.82 During the Inquiry, a witness told me that in September 2007, pharmacists at Coffs Harbour Hospital recorded the results of a review of 180 medication charts, to which the pharmacists made 307 changes. The changes related to inappropriate prescription of drugs, dispensing of medication at inappropriate times of the day and with inappropriate frequency and improper doses.¹²⁵
- 9.83 During a hearing, a clinical pharmacist reminded me of a real benefit when she said:
- "[I]t is really useful to have a clinical pharmacist to review the medication charts, particularly when the medication charts [aren't] always legible..."¹²⁶
- 9.84 During my Inquiry, I was referred to an article in the *British Journal of Pharmacology*. The article contained a review of a study of 8 Australian Hospitals conducted over 21 days. St Vincent's and Royal North Shore Hospitals were the NSW examples. The

study concluded that every dollar spent on a pharmacist's wage saves \$23 in the quality use of medicine. It did so on the basis of these factors:¹²⁷

- (a) for the 24,866 overnight admissions over the 21 days, there were 1,399 pharmacist initiated changes to maintain prescriptions, that is 56.3 interventions per 1,000 admissions;
- (b) the calculated savings from these interventions was \$263,221. On an annual basis, these 8 hospitals may have saved some \$4,444,794;
- (c) of the 1,399 pharmacist initiated changes:
 - (i) 1,346 had an impact on one or more of either the length of stay, re-admission probability, drug costs, medical procedures or laboratory monitoring;
 - (ii) 835 impacted on drug costs;
 - (iii) 351 addressed very serious drug related problems;
 - (iv) 156 reduced the patient's potential to be re-admitted to the hospital;
 - (v) 96 resulted in a reduced hospital stay; and
 - (vi) 15 were life saving.
- (d) when annualised, every dollar spent on a pharmacist to initiate changes in drug therapy or management, creates a saving of approximately \$23. The savings in the study were comparable with those found in smaller studies.¹²⁸

9.85 I was told at a meeting with the Society of Hospital Pharmacists of Australia, that on average, drug costs account for 5% of the cost of running a hospital.¹²⁹ Of NSW Health's total expenditure in 2006-07 of \$12.04 billion, drug supplies cost \$421.7 million which is 3.5% of the NSW Health budget.¹³⁰ Such potential drug savings are not to be lightly dismissed.

9.86 I was also directed to a study indicating that a decrease in pharmacy staffing led to an increase in mortality rates.¹³¹ Such a finding would be consistent with the role of pharmacists in reducing medication errors.

9.87 Clinical pharmacy review is widely regarded as an important safety precaution to reduce medication incidents.¹³² Several hospitals in outer metropolitan and rural areas reported they did not have enough pharmacy staff to provide a clinical pharmacy review and were reduced to essentially a dispensing role.¹³³ I understand that in some circumstances, NSW patients do not receive any service whatsoever from clinical pharmacists.¹³⁴

9.88 When the Society for Hospital Pharmacists of Australia developed 'Standards of Practice for Clinical Pharmacy',¹³⁵ it made a number of recommendations including establishing the ratios:

- (a) 15 critical care beds per pharmacist; and
- (b) 40 beds per pharmacist for surgical areas.

9.89 A witness during a hearing at Lismore Hospital said:

"The service that we provide now for Lismore is roughly equivalent to the supply based service that was provided then in 1978... We don't have the funding to fund the staff necessary to provide that service."¹³⁶

9.90 Another pharmacist said:

"The number of patients each pharmacist has is between double and three times the number they should have to provide an effective and safe service. I personally have 78 patients each day ... plus I take students from the University ..."

"Due to time restrictions we do not interview each patient regarding the medications they take at home... We do not have staff to counsel patients on their discharge medications... We do not provide lists of the medications patients are to take home ... We do not have time to accompany doctors on ward rounds... We do not have time to read through each patient's notes to find out what is happening to them on a day to day basis... Some wards are not even covered by a pharmacist... We need more staff."¹³⁷

- 9.91 I was informed that Murwillumbah Hospital has 100 beds, one pharmacist and no clinical pharmacy review. I was also informed that Byron Bay Hospital and Mullumbimby Hospital only have a pharmacist who visits one day a week¹³⁸ and have no hospital pharmacy department.
- 9.92 I understand that there is no ward pharmacist at John Hunter Hospital. As a result, nursing staff are required to photocopy and transmit patient drug charts to the pharmacy in order to obtain more drugs.¹³⁹
- 9.93 I received many submissions to the effect that the level of staffing in NSW was under the level recommended in NSW and in other States.¹⁴⁰ By way of illustration, the vacancy rate amongst hospital pharmacists for NSW was 11% against the national average of 7%.¹⁴¹

Recommendation 28: *NSW Health should ensure that there is developed standard guidelines which involve consultation by and the participation of clinical pharmacists in the care of patients at the earliest appropriate opportunity so as to enable a clinical pharmacist to take a patient's medication history, participate in ward rounds, review the patient's medical chart during their inpatient stay and review medications on discharge.*

Recruitment challenges due to pay disparity

- 9.94 The evidence before the Inquiry, consistently, was that pharmacists who work outside the public health system are paid considerably more than hospital pharmacists. One witness told me:

"Community pharmacists are paid maybe double what a hospital pharmacist is being paid."¹⁴²

- 9.95 Submissions received from NSW pharmacists revealed:

"... the current award structure in New South Wales means that a pharmacist ... who registers as a pharmacist after their postgraduate masters degree or their undergraduate degree, both followed by a year's supervised training, earns exactly the average wage. They get about \$1 extra per hour once they register. That is about half of what they could earn in an outside pharmacy, particularly in a regional area. The idea of being able to recruit and retain those pharmacists is not really realistic."¹⁴³

"Currently the pay rate is about \$24 per hour for a new graduate, who may have five years university training ... and they can currently get first year out in a community pharmacy anywhere from \$36 to \$45 per hour."¹⁴⁴

9.96 During my Inquiry some pharmacists said:

"Although we are able to fill graduate training positions (we had 93 applicants for 2 positions last year) junior pharmacists are leaving [St Vincent's Hospital] and the hospital system within one to 2 years."¹⁴⁵

9.97 I received the following suggestions on ways to improve recruitment and retention:

- (a) job satisfaction could be improved by remedying many of the problems that beset allied health professionals such as inadequate staffing levels,¹⁴⁶ no backfilling, and limited access to professional education;¹⁴⁷
- (b) community pharmacists should be trained and used as short term hospital dispensary locums to help fill temporary positions.¹⁴⁸
- (c) provide family friendly, flexible working arrangements and re-entry programmes for pharmacists to return to hospital pharmacy;¹⁴⁹
- (d) increase the exposure of pharmacy graduates to hospital pharmacy by increasing pre-registration training positions in NSW hospitals and associated funding.¹⁵⁰ I was told that the number of pharmacy graduates has increased but the number of pre-registration training positions has not.¹⁵¹ One pharmacist suggested that pharmacy graduates should have a compulsory training of one year at a hospital before they can become registered to own a pharmacy outside;¹⁵²
- (e) fund a higher qualification allowance, recognising the achievement of higher qualifications.
- (f) fund postgraduate clinical pharmacy programmes;¹⁵³ I was told during a hearing at Royal North Shore Hospital that:

"In the UK the basic-rate pharmacists are usually attracted into hospital setting by the fact that the hospital will provide a 2 year postgraduate clinical diploma. ... It is a great shame we are not able to provide that drawcard ... We really rely on in-house training of pharmacists which is another problem. We don't have any pharmacy educators."¹⁵⁴

- (g) allocate time for senior pharmacists to mentor and train junior pharmacists and consider funding for a dedicated in-house clinical pharmacy educator – to educate nurses, doctors and colleagues.¹⁵⁵

Pharmacy Technicians

9.98 Another suggestion to alleviate some of the workload on hospital pharmacists is to employ pharmacy technicians to perform certain limited roles.¹⁵⁶ Technicians in the United Kingdom provide a range of extended services that are performed in NSW by registered pharmacists.¹⁵⁷

9.99 In the United Kingdom, a pharmacy technician can perform the following tasks:¹⁵⁸

- (a) take medication histories;
- (b) assess current medication management;
- (c) clinical review;
- (d) therapeutic drug monitoring;
- (e) information for ongoing care; and
- (f) order stock.¹⁵⁹

- 9.100 To become a pharmacy technician, a candidate must complete the relevant Certificate III or IV qualification or equivalent.¹⁶⁰ Charles Sturt University has the only accredited training course in NSW for pharmacy technicians.

Recommendation 29: *NSW Health consider the enhancement of the clinical pharmacists' work force in public hospitals by:*

- (a) *encouraging the obtaining of higher qualifications by clinical pharmacy staff;*
- (b) *incorporating for clinical pharmacists a component relating to training time both of pre-registration pharmacists (or trainees), new graduates in the hospital, and by the provision of clinical pharmacy educator;*
- (c) *fostering arrangements with community pharmacists so as to encourage a better exchange of pharmacists between the community and the hospital; and*
- (d) *identifying the tasks which may be performed by a pharmacist assistant and designing a position for such an assistant in order to free up a clinical pharmacist to spend more time engaged in patient care.*

Discharge medications

- 9.101 The Commonwealth Government has constitutional power to make laws relating to the provision of pharmaceutical benefits.¹⁶¹ Under this power, the Commonwealth Government funds the Pharmaceutical Benefits Scheme ("PBS"). The PBS provides the public with access to lifesaving and necessary medications at an affordable subsidised price. Only those medications listed on the pharmaceutical benefits schedule are price subsidised. As of 1 August 2008, general category patients pay up to a maximum of \$31.30 per prescription item whereas concession card holding patients pay up to a maximum of \$5.00.¹⁶²
- 9.102 Commonwealth Government expenditure on the PBS for the year ending 30 June 2006 amounted to \$6.1 billion for the whole of Australia. For the year ending 30 June 2007 Australian PBS expenditure amounted to \$6.43 billion, a 4.3 percent increase on the previous year,¹⁶³ with around \$2.29 billion, attributed to New South Wales, \$1.65 billion to Victoria and \$1.26 billion to Queensland.¹⁶⁴
- 9.103 The total number of PBS prescriptions for the whole of Australia was 168.5 million¹⁶⁵ with around 57.9 million coming from New South Wales (up 0.41 percent on the previous year¹⁶⁶), 42.5 million (down 0.29 percent) from Victoria and 31.9 million (up 1.62 percent) from Queensland.¹⁶⁷ The average cost to the Government per script is \$32.50.¹⁶⁸
- 9.104 Continuity of care would suggest that hospitals should provide patients with medication on discharge from hospital, to continue the treatment regime begun in the hospital.¹⁶⁹ However, the costs of such medication comes out of the hospital's budget, which is funded by the State Government.¹⁷⁰ Frequently, hospitals do not provide medications on discharge at all, or only a few days' supply which may not be sufficient for the patient to get to the community pharmacist.
- 9.105 During my Inquiry, I noticed the three different practices for the issuing of medication on discharge at hospitals in NSW were:
- (a) no medication, unless there are extenuating circumstances.¹⁷¹

(b) medication supply for 3 to 5 days.¹⁷² During a hearing, one witness said:

"We only have funding to give people inpatient medication. Even on discharge, we don't have funding for that really. We shouldn't be giving any medications on discharge because technically, the patient becomes a community patient and that reverts to federal funding, so we're being told we can only give three days supply on discharge."¹⁷³

(c) non PBS medication, 1 months' supply at a price subsidised by the State Government.¹⁷⁴

9.106 To continue taking the same course of medication, the patient has to obtain a new prescription from their general practitioner and present it to a community pharmacy where the medicine is dispensed at a subsidised cost – so long as it is funded under the PBS.

9.107 In addition to impediments created by varied practices and a lack of funding, paragraph 4.4.1.2 of the Medication Handling in NSW Public Hospitals Policy provides that:

"...all hospitals must pay for the cost of all pharmaceuticals provided to patients at discharge. Patients are to be dispensed an adequate quantity of medication by the hospital pharmacy to ensure continuity until the patient is able to obtain further supplies outside the hospital. ..."¹⁷⁵

9.108 This does not appear to be happening universally. Paragraph 4.4.1.3 of this policy also directs that discharge medication only be dispensed on a separate authorisation, to the in-patient order. In practice, this leads to a new batch of medications being issued which can and generally does result in wastage.

9.109 I heard that upon admission, a patient would receive an initial supply of medicine for 7 days. Upon discharge, that patient would receive a fresh supply of medication for 3 days and the unused medication issued on admission would be disposed of because it did not have the correct dosage label.¹⁷⁶ It appears wasteful to dispose of those in-patient medications, that were freshly dispensed again on discharge. This is especially wasteful if the patient is discharged say for example after two or three days. Surely, those medicines that were re-useable could be used by the patient on discharge with an amended label and prescription regime. This seems a waste of hospital resources given the cost of medications, the cost of dispensing and the limited hospital budget.

9.110 I was also told medications were sometimes not transferred with a patient between wards. Instead the old batch is disposed and a new batch is dispensed for the new ward.¹⁷⁷ This wastage seems to have no rational justification and ought to be able to be avoided.

9.111 The Outpatient Pharmaceutical Charges and Safety Net Arrangements Policy¹⁷⁸ of NSW Health also governs the provision of pharmaceuticals to patients upon discharge. I was told that where a full course of medication is provided, the public hospital is entitled to charge the patient a co-payment.¹⁷⁹ The policy directs that the take home supply of medication should not exceed a maximum of 7 days' worth.¹⁸⁰ There are exceptions for patients from country areas requiring long term therapy.¹⁸¹

9.112 It appears to me, that the problems for patient care with not providing medications to patients on discharge from hospital include:

(a) some patients who are not inclined to comply with the treatment regime do not obtain a PBS prescription or have a prescription filled, and the hard work of the

hospital is to some extent undone particularly when patients return to the Emergency Department for re-admission.¹⁸²

- (b) some patients, particularly in rural areas, have trouble getting prescriptions. Even after driving some distance there is a risk they cannot see their general practitioner to get a script, as the doctor is booked out.¹⁸³ And some patients cannot have it filled after finding the pharmacy, as the pharmacy does not stock the required item.
- (c) some patients although well enough to be discharged may not, without help, be physically able to make their own way to a doctor.
- (d) in border towns, such as Tweed Heads, a prescription written in NSW may not be valid in Queensland causing difficulties for patients getting a prescription filled.¹⁸⁴

Single Source Funding

- 9.113 These problems do not exist in countries with a single funding source, such as the United Kingdom, where patients receive up to 28 days medication on discharge where clinically appropriate.¹⁸⁵ This apparently reduces duplication and wastage of medicines. It may also help reduce the re-admission of patients due to difficulties obtaining medication. The job of reconciling patient medication history upon admission, might also be simpler if hospital practitioners have access to PBS system patient medication records. This would save practitioner time and help reduce the number of medication errors and adverse drug events experienced by patients.¹⁸⁶
- 9.114 So far as my researches show, in Queensland, Victoria, the Northern Territory, Western Australia¹⁸⁷ and more recently South Australia,¹⁸⁸ prescribers at approved participating public hospitals provide discharge medications and bill the Commonwealth PBS.
- 9.115 I have been told the disadvantage is that those hospitals have experienced considerable difficulty getting money back from the PBS as the forms are difficult to complete correctly and any error leads to the rejection of the claim.¹⁸⁹ But this is a processing issue which ought not detract from the principle. I note however, there is a Government online training aid freely available on the Internet, entitled "PBS and You". It is aimed at teaching new prescribers about the PBS system and includes information on how to complete the PBS forms. The course takes 15 minutes to complete.¹⁹⁰
- 9.116 The Society of Hospital Pharmacists informed me that PBS funding may require more hospital administrative staff to chase PBS accounting claims.¹⁹¹ I note electronic prescribing might help this problem, with direct lodgement of PBS claims to the Government over the internet. Online PBS claiming was introduced in late 2004.¹⁹² Errors that are present in a prescription are returned to the pharmacists in real time.¹⁹³ Community pharmacists have been using the online claim system for some time. It ought to be able to be adopted for hospital billing.
- 9.117 NSW hospitals do not bill the patient or the PBS for providing discharge medication. Part 7, clause 45 of the present Australian Health Care Agreement between the Commonwealth and NSW 2003-2008 requires, NSW to pay for public hospital services provided to an eligible public patient in a public hospital. Clause 45 is subject to the exceptions in clause 46, this clause provides that fees can be charged to admitted patients on separation for pharmaceuticals at a level consistent with the PBS.¹⁹⁴

"46. Notwithstanding the principle in clause 6(a), fees may be charged for the following services provided to non-admitted patients and, in relation to (e) only, to admitted patients upon separation:

(e) pharmaceuticals at a level consistent with the Pharmaceutical Benefits Scheme statutory co-payments.”

- 9.118 Clause 21 of the Australian Health Care Agreement between the Commonwealth and NSW differs to the equivalent provisions of the agreements between the Commonwealth and the other states. For example, in NSW the clause provides:

“Subject to signing an agreement between the Commonwealth and New South Wales on issues including the rate of reimbursement, appropriate clinical guidelines, data requirements and risk sharing arrangements, pharmaceuticals may be provided through the Pharmaceutical Benefits Scheme (PBS) to admitted public and private patients on separation, to non-admitted patients and to day admitted patients for a range of cancer chemotherapy drugs made available by specific delivery arrangements provided under section 100 of the *National Health Act 1953*.”

- 9.119 The Victorian and Queensland equivalents provide that those states agree with the Commonwealth to:

“... continue the implementation of the arrangements agreed pursuant to clause 35 of the 1998-2003 Australian Health Care Agreements. These arrangements extend access to the Pharmaceutical Benefits Scheme (PBS) to admitted public and private patients on separation, non-admitted patients and certain chemotherapy pharmaceuticals as defined in the Commonwealth-State pharmaceutical agreements will be made available to public hospitals.”¹⁹⁵

- 9.120 Clause 21 in the agreement in South Australia is in similar terms to the agreement signed by NSW, but in May 2008 South Australia Health announced PBS billing for public hospital inpatients.¹⁹⁶ I understand that South Australia negotiated an agreement with the Commonwealth government to implement PBS reform and as a result 70 new pharmacist positions were negotiated to help implement the reform.¹⁹⁷

- 9.121 Section 94 of the *Commonwealth National Health Act 1953* (“Act”), allows a hospital authority to apply for ministerial approval to supply pharmaceutical benefits.¹⁹⁸ Ministerial approval is subject to conditions as the Minister determines.¹⁹⁹ A public hospital must be participating in the Public Hospital Pharmaceutical Reforms under the Australian Health Care Agreement before it can be approved under section 94 of the Act.²⁰⁰ NSW Health does not appear to be participating in those reforms.

- 9.122 The NSW Branch of the Society of Hospital Pharmacists of Australia is concerned about the inconsistent uptake of the pharmaceutical reforms across Australia. It supports improvements in access for medicines in a nationally consistent manner.²⁰¹ I have heard the Commonwealth Government is in the process of negotiating PBS reform with NSW Health for NSW public hospitals. It seems to me that this is one area crying out for urgent reform in the interest of patient care.

¹ This definition is adopted from the proposal for the categorisation of “allied health professional” contained in Lowe S, et al, Services for Australian Rural and Remote Allied Health, *A Framework for the Categorization of the Australian Health Professional Workforce*, July 2007, pp. 4-5, <http://sarrah.org.au/site/index.cfm>, (20 August 2008).

² See detailed analysis contained in the Australian Health Workforce Advisory Committee Report, *The Australian Allied Health Workforce: An Overview of Workplace Planning Issues*,

AHWAC Report 2006.1 <http://www.nhwt.gov.au/publications.asp> (4 August 2008) and Lowe S, et al, Services for Australian Rural and Remote Allied Health, *A Framework for the Categorization of the Australian Health Professional Workforce*, July 2007, <http://sarah.org.au/site/index.cfm> (20 August 2008).

- 3 This list is adopted from the broad categorisation of allied health professionals referred to in the Australian Health Workforce Advisory Committee Report, *The Australian Allied Health Workforce: An Overview of Workplace Planning Issues*, AHWAC Report 2006.1, p. 26, <http://www.nhwt.gov.au/publications.asp> (12 August 2008).
- 4 Unless stated otherwise, this information is available in NSW Health, *NSW Health Service Health Professionals (State) Award*, IB2007_059.
- 5 Adapted from Australian Physiotherapy Association website, http://apa.advsol.com.au/physio_and_health/improve/what.cfm (20 August 2008).
- 6 NSW Health, *NSW Health Service Health Professionals (State) Award*, IB2007_059.
- 7 Adapted from Australian Association of Occupational Therapists website, http://www.otnsw.com.au/ot/what_is_ot.php (6 August 2008).
- 8 Adapted from Speech Pathology Australia website, <http://www.speechpathologyaustralia.org.au> (6 August 2008).
- 9 Adapted from the general description of accredited practicing dietitians contained on the Dietitians Association of Australia website, <http://www.daa.asn.au/index.asp> (6 August 2008).
- 10 Adapted from Clause 2, *Health and Community Employees Psychologists (State) Award*, http://www.health.nsw.gov.au/resources/jobs/conditions/awards/pdf/hsu_hc_psychologists.pdf (15 August 2008).
- 11 Clause 2, *Health and Community Employees Psychologists (State) Award*, http://www.health.nsw.gov.au/resources/jobs/conditions/awards/pdf/hsu_hc_psychologists.pdf, (15 August 2008).
- 12 Adapted from the Australian Association of Social Workers submission to the Committee on the Health Care Complaints Commission, http://www.aasw.asn.au/adobe/about/branches/nsw/2006/AASW_NSW_HCC_Submission.pdf (18 August 2008).
- 13 Adapted from the Society of Hospital Pharmacists Australia website, <http://www.shpa.org.au> (15 August 2008).
- 14 Clause 2, *Health Employees' Pharmacists (State) Award*, http://www.health.nsw.gov.au/resources/jobs/conditions/awards/pdf/hsu_he_pharmacists.pdf (15 August 2008).
- 15 Submission of the Area Directors of Allied Health Council, 28 March 2008, SUBM.002.0177 at 179.
- 16 NSW Health, *Integrated Primary and Community Health Policy 2007 - 2012*, PD2006_106.
- 17 Julia Batty, Sydney Children's Hospital hearing, 19 May 2008, transcript 3005.10-19; Submission of Julia Batty, 19 May 2008, SUBM.035.0119 at 122.
- 18 Fary R "Increased Work Value –The Case for Physiotherapy 2004", report commissioned by the Australian Physiotherapy Association, 2004, p. 172-3, <http://apa.advsol.com.au/independent/documents/submissions/ProductivitySubmissionAttachment1.pdf> (14 November 2008). This report is referred to in the written Submission of the Australian Physiotherapy Association, 31 March 2008, SUBM.020.0086 at 101.
- 19 Submission of the Area Directors of Allied Health Council, 28 March 2008, SUBM.002.0177 at 179.
- 20 Greater Metropolitan Clinical Taskforce, *An Australian Model for Clinical Governance: Summary*, 2008, p.10, http://www.health.nsw.gov.au/resources/gmct/clinical_governance_oct2007_pdf.asp (6 August 2008).
- 21 Julie Hartley-Jones, Royal North Shore Hospital hearing, 2 April 2008, transcript 1295.8-15.
- 22 Paula Harman, Royal North Shore Hospital hearing, 14 March 2008, transcript 282.22-25.
- 23 Mary Eleanor McCaskill, Children's Hospital, Westmead hearing, 15 May 2008, transcript 2939.10-13.

-
- 24 Submission of NSW Health, 14 April 2008, SUBM.075.0002 at 101.
- 25 Submission of the Australian Physiotherapy Association, 31 March 2008, SUBM.020.0086 at 95.
- 26 Submission of Hunter New England Area Health Service Allied Health Committee, 20 May 2008, SUBM.049.0074 at 76; Submission of the Area Directors of Allied Health Council, 28 March 2008, SUBM.002.0177 at 179; Jibuike O et al, "Management of soft tissue knee injuries in an accident and emergency department: the effect of the introduction of a physiotherapy practitioner" (2003) 20 *Emergency Medicine Journal* 37.
- 27 Editorial "Rehabilitation: an integral part of clinical practice" (2006) 56 *Occupational Medicine* 289.
- 28 Stucki G et al, "Rationale and principles of early rehabilitation care after an acute injury or illness" (2005) 27(7/8) *Disability and Rehabilitation* 353; Skinner E et al, "Rehabilitation and exercise prescription in Australian intensive care units" (2008) 94 *Physiotherapy* 220.
- 29 Submission of the Australian Physiotherapy Association, 31 March 2008, SUBM.020.0086 at 90; Plant PK et al, "Cost effectiveness of ward based non-invasive ventilation for acute exacerbations of chronic obstructive pulmonary disease: economic analysis of randomized controlled trial" (2003) 326 *British Medical Journal* 1.
- 30 Meeting with Greater Metropolitan Clinical Taskforce, 7 March 2008, transcript 20.23-45.
- 31 Submission of the Australian Physiotherapy Association, 31 March 2008, SUBM.020.0086 at 99.
- 32 In 2007/08, the NSW Health total medical/nursing/allied health workforce was 54,386 full-time equivalent. Medical staff made up 14.5%, nursing 71.7% and allied health 13.8%: Email from NSW Health to Special Commission of Inquiry, 17 November 2008. Data obtained from unaudited NSW Health 2007/08 Annual Report. (Note: the calculations exclude third schedule facilities and Visiting Medical Officers).
- 33 NSW Health Briefing, 4 April 2008, transcript 108.41-109.5.
- 34 Submission of NSW Health, 14 April 2008, SUBM.075.0002 at 100.
- 35 James Stormon, Prince of Wales hearing, 1 May 2008, transcript 2595.19-29.
- 36 GMCT/NSW Health Metropolitan Hospital Allied Health Project - Clinical Interventions & Staffing Guidelines, *Project review and Closure Report - Phase 1*, http://www.health.nsw.gov.au/resources/gmct/pdf/alliedhealthproject_fullreport_final.pdf p. 5 and Appendix A (20 August 2008).
- 37 Letter from NSW Health Special Commission of Inquiry, 15 October 2008.
- 38 Mary Eleanor McCaskill, Children's Hospital, Westmead hearing, 15 May 2008, transcript 2939.17-21.
- 39 Department of Education, Employment and Workplace Relations (Commonwealth), *Health Professions Occupational Reports: Dietitian (Australia)*, 2007, <http://workplace.gov.au/workplace/Publications/LabourMarketAnalysis/SkillShortages/OccupationalReports/HealthProfessions.htm> (19 August 2008).
- 40 Department of Education, Employment and Workplace Relations (Commonwealth), *Health Professions Occupational Reports, 2007*, <http://workplace.gov.au/workplace/Publications/LabourMarketAnalysis/SkillShortages/OccupationalReports/HealthProfessions.htm> (19 August 2008).
- 41 Department of Education, Employment and Workplace Relations (Commonwealth), *Health Professions Occupational Reports: Speech Pathologist (Australia)*, 2007, <http://workplace.gov.au/workplace/Publications/LabourMarketAnalysis/SkillShortages/OccupationalReports/HealthProfessions.htm> (19 August 2008)
- 42 Patricia Anne Heaton, Royal North Shore Hospital II hearing, 2 April 2008, transcript 1167.23-26.
- 43 Submission of Australian Physiotherapy Association, 31 March 2008, SUBM.020.0086 at 103.
- 44 Submission of Judith Rosonakis, 10 April 2008, SUBM.049.0136 at 136.
- 45 Kerry Ann Shanahan, Mudgee hearing, 20 March 2008, transcript 754.22-30; Jodie McAlpine, Mudgee hearing, 20 March 2008, transcript 71129-32

-
- 46 Jodie McAlpine, Mudgee hearing, 20 March 2008, transcript 711.23-44.
- 47 Confidential Westmead hearing, 26 May 2008, transcript 25.5-9.
- 48 Barbara Heaton, Royal North Shore Hospital hearing, 2 April 2008, transcript 1167.16-33.
- 49 Confidential Westmead hearing, transcript 25.27-29.
- 50 Confidential Westmead hearing, 26 May 2008, transcript 25.11-17.
- 51 Submission of Royal North Shore Hospital Physiotherapy Department, 2 April 2008, SUBM.011.0299; NSW Health Briefing, 4 April 2008, transcript 107.46-108.9.
- 52 Pamela Barrett, Tweed Heads Hospital hearing, 29 April 2008, transcript 2388.24-32.
- 53 Susan Henderson, Royal North Shore Hospital hearing, 14 March 2008, transcript 392.19-23.
- 54 Lyn Biviano, Children's Hospital Westmead hearing, 15 May 2008, transcript 2985.15-25.
- 55 Confidential Westmead hearing, 26 May 2008, transcript 27.38-45.
- 56 Submission of Prince of Wales Physiotherapy Department, 1 May 2008, SUBM.029.0505 at 506.
- 57 Confidential Bankstown Hospital hearing, 13 May 2008, transcript 35.32-42.
- 58 Clause 12(iii), *Public Hospitals (Professional and Associated Staff) Conditions of Employment (State) Award*, http://www.health.nsw.gov.au/resources/jobs/conditions/awards/pdf/hsu_ph_profassociated_staff.pdf (14 November 2008).
- 59 Clause 13(vi) and clause 16, respectively, *Public Hospitals (Professional and Associated Staff) Conditions of Employment (State) Award*, http://www.health.nsw.gov.au/resources/jobs/conditions/awards/pdf/hsu_ph_profassociated_staff.pdf (14 November 2008).
- 60 Clause 27A(v), *Public Hospitals (Professional and Associated Staff) Conditions of Employment (State) Award*, http://www.health.nsw.gov.au/resources/jobs/conditions/awards/pdf/hsu_ph_profassociated_staff.pdf (14 November 2008).
- 61 For example: James Ignatius Stormon, Prince of Wales Hospital hearing, 1 May 2008, transcript 2592.11-35; Elizabeth McCall, Lismore hearing, 28 April 2008, transcript 2258.44-45; Lyn Angelo Biviano, Children's Hospital, Westmead hearing, 15 May 2008, transcript 2985.29-41; Julia Batty, Sydney Children's Hospital hearing, 19 May 2008, transcript 3001.9-3002.19; Submission of the Allied Health Alliance of NSW, 27 March 2008, SUBM.012.0219 at 220; Submission of the Hunter New England Area Health Service Area Allied Health Committee, 20 May 2008, SUBM.049.0074 at 76; Patricia Heaton, Royal North Shore Hospital hearing II, 2 April 2008, transcript 1166.43-1167.44; Submission of James Stormon, 1 May 2008, SUBM.029.0501 at 502.
- 62 Margaret Bramwell, Royal North Shore Hospital hearing, 2 April 2008, transcript 1302.46-1303.1.
- 63 NSW Health Briefing, 4 April 2008, transcript 108.4-9.
- 64 Barbara Heaton, Royal North Shore Hospital hearing, 2 April 2008, transcript 1167.9-14.
- 65 Margaret Bramwell, Royal North Shore Hospital hearing, 2 April 2008, transcript 1303.27-28.
- 66 Michael Edwin Holloway, Tweed Heads hearing, 29 April 2008, transcript 2309.12-17.
- 67 Ann Stublely, Sydney Children's Hospital hearing, 19 May 2008, transcript 3031.5-8.
- 68 NSW Health, *Recruitment of Nurses and Midwives – Framework*, PD2008_045.
- 69 Confidential submission, 29 April 2008, SUBM.020.0140 at 142.
- 70 Jan-Maree Tweedie, Royal North Shore Hospital hearing, 14 March 2008, transcript 314.14-15.
- 71 James Ignatius Stormon, Prince of Wales Hospital hearing, 1 May 2008, transcript 2593.15-32.
- 72 Submission of the NSW Branch of the Australasian Faculty of Rehabilitation Medicine, 27 March 2008, SUBM.013.0202 at 202; Skinner E et al., "Rehabilitation and exercise prescription in Australian intensive care units" (2008) 94 *Physiotherapy* 220; Stucki G. et al.,

-
- "Rationale and principles of early rehabilitation care after an acute injury or illness" (2005) 27(7/8) *Disability and Rehabilitation* 353.
- ⁷³ Submission of the Hunter New England Area Health Service Area Allied Health Committee, 20 May 2008, SUBM.049.0074 at 75-76.
- ⁷⁴ Confidential Westmead hearing, 26 May 2008, transcript 24.19-31; Lyn Angelo Biviano, Children's Hospital, Westmead hearing, 15 May 2008, transcript 2984.34-41.
- ⁷⁵ Confidential Coffs Harbour hearing, 27 March 2008, 13.41-14.9.
- ⁷⁶ Confidential Westmead hearing, 26 May 2008 transcript 24.6-31.
- ⁷⁷ Submission of the Hunter New England Area Health Service Area Allied Health Committee, 20 May 2008, SUBM.049.0074 at 76.
- ⁷⁸ Fran Maree Hodgson, Newcastle hearing, 12 May 2008, transcript 2810.8-14.
- ⁷⁹ Confidential submission, 29 April 2008, , SUBM.020.0140 at 141.
- ⁸⁰ Robyn Alexander, Wollongong hearing, 14 April 2008, transcript 1633.45-1634.7.
- ⁸¹ Submission of the Australian Physiotherapy Association, 31 March 2008, SUBM.020.0086 at 93.
- ⁸² Submission of the Australian Physiotherapy Association, 31 March 2008, SUBM.020.0086 at 93-94.
- ⁸³ Elizabeth McCall, Lismore hearing, 28 April 2008, transcript 2258.34-41.
- ⁸⁴ NSW Health Briefing, 4 April 2008, transcript 108.25-34.
- ⁸⁵ NSW Health Briefing, 4 April 2008, transcript 108.37-39.
- ⁸⁶ Confidential Coffs Harbour hearing, 27 March 2008, transcript 12.35-38.
- ⁸⁷ Confidential submission, 22 February 2008, SUBM.014.0223 at 223.
- ⁸⁸ Confidential Westmead hearing, 26 May 2008, transcript 24.33-36.
- ⁸⁹ Julia Batty, Sydney Children's Hospital hearing, 15 May 2008, transcript 3009.47.
- ⁹⁰ Submission of the Hunter New England Area Health Service Area Allied Health Committee, 20 May 2008, SUBM.049.0074 at 77.
- ⁹¹ See generally, GMCT/NSW Health Metropolitan Hospital Allied Health Project - Clinical Interventions & Staffing Guidelines, *Project review and Closure Report - Phase 1*, http://www.health.nsw.gov.au/resources/gmct/pdf/alliedhealthproject_fullreport_final.pdf (20 August 2008) p. 7 and Appendix A.
- ⁹² Louis McGuigan, *Discussion Paper: Workplace Culture in NSW Health*, provided with submission of the Hospital Reform Group of NSW, SUBM.005.0431 at 436-7; Submission of POW Physiotherapy Department, 1 May 2008, SUBM.029.0505 at 506.
- ⁹³ Submission of the Area Directors of Allied Health Council, 28 March 2008, SUBM.002.0178 at 179.
- ⁹⁴ By the Industrial Relations Commission ("Commission") of New South Wales. Subsequent variations were approved by the Commission on 12 December 2007: NSW Health, *Information Bulletin: NSW Health Service Health Professionals (State) Award*, IB2007_059.
- ⁹⁵ NSW Health, *Information Bulletin: NSW Health Service Health Professionals (State) Award*, IB2007_059.
- ⁹⁶ Submission of NSW Health, 14 April 2008, SUBM.075.0002 at 101.
- ⁹⁷ NSW Health, *Information Bulletin: NSW Health Service Health Professionals (State) Award*, IB2007_059.
- ⁹⁸ *Health Employees' Pharmacists (State) Award*, page 6-7
http://www.health.nsw.gov.au/resources/jobs/conditions/awards/pdf/hsu_he_pharmacists.pdf
15 August 2008.
- ⁹⁹ Dawn Astles, Royal North Shore Hospital hearing, 2 April 2008, transcript 1222.34-42.
- ¹⁰⁰ Part B, Table 1, *Health and Community Employees Psychologists (State) Award*, http://www.health.nsw.gov.au/resources/jobs/conditions/awards/pdf/hsu_hc_psychologists.pdf (15 August 2008).
- ¹⁰¹ Brenda McLeod, Chief Allied Health Officer, Workforce and Leadership Branch, NSW Health, *NSW Allied Health Advisory Network*, Presentation to the National Allied Health

Conference, July 2007,
[http://proceedings.com.au/nahc/presentations%20\(pdf\)/weds_mccleod.pdf](http://proceedings.com.au/nahc/presentations%20(pdf)/weds_mccleod.pdf), p. 5 (18 August 2008).

- ¹⁰² NSW Health Briefing, 4 April 2008, transcript 105.13-18.
- ¹⁰³ NSW Health Briefing, 4 April 2008, transcript 105.13.
- ¹⁰⁴ Louis McGuigan, *Discussion Paper: Workplace Culture in NSW Health*, provided with submission of the Hospital Reform Group of NSW, SUBM.005.0431 at 436-7.
- ¹⁰⁵ Submission of NSW Health, 14 April 2008, SUBM.075.0002 at 100.
- ¹⁰⁶ Submission of the Allied Health Alliance, 27 March 2008, SUBM.012.0219 at 220.
- ¹⁰⁷ Evidence of Patricia Heaton, Royal North Shore Hospital hearing, 2 April 2008, transcript 1165.26-29.
- ¹⁰⁸ Material provided by Northern Sydney Central Coast Area Health Service in response to summons, NSCC.020.0009 at 9.
- ¹⁰⁹ I received submissions in support of discipline specific management: for example, see Australian Physiotherapy Association, *Position Statement: Physiotherapy Management*, provided in submission of Australian Physiotherapy Association, 31 March 2008, SUBM.020.0086 at 106-7.
- ¹¹⁰ Directors and Chairs of the Allied Health Advisory Group, *Consensus Statement: Principles Underpinning Allied Health Governance*, September 2004, Appendix 2 in submission of the Area Directors of the Allied Health Council, 28 March 2008, SUBM.002.0177 at 187.
- ¹¹¹ Theresa Beswick, Coffs Harbour hearing, 27 March 2008, transcript 1042.38-47; Confidential Coffs Harbour hearing, 27 March 2008, transcript 7.36-8.21.
- ¹¹² Confidential Coffs Harbour hearing, 27 March 2008, transcript 3.21-39. In September 2007, pharmacists review of 180 medication charts caused 307 changes to be made: Confidential Coffs Harbour hearing, 27 March 2008, transcript 5.9-28; Submission of Terry Melocco, Gillian Campbell, Susan Welch, Maree Brown, 5 June 2008, SUBM.074.0013 at 13-15.
- ¹¹³ O'Leary KM, Allinson YM, "Pharmaceutical Review: Resource Implications for the Pharmacy Component in Australian Public Hospitals", (2006) 36(4) *Journal of Pharmacy Practice and Research* 291, p. 293.
- ¹¹⁴ NSW Health, *Incident Management in the NSW Health System 2007: January to June*, 2008, NSW Health, North Sydney, p. 13; NSW Health, *Incident Management in the NSW Health System 2007: July to December*, 2008, NSW Health, North Sydney, p. 18.
- ¹¹⁵ Submission of Margaret Duguid and Jenny Crane, 25 March 2008, SUBM.004.0142 at 147-8.
- ¹¹⁶ Fairbanks RJ et al, "Medical and Nursing staff highly value clinical pharmacists in the emergency department" (2007) 24(10) *Emergency Medical Journal* 716, p. 718; Carter MK et al, "Pharmacist acquired medication histories in a university hospital emergency department" (2006) 63(24) *American Journal of Health System Pharmacy* 2500, pp. 2500-2503.
- ¹¹⁷ Michael Holloway, Tweed Heads hearing, 29 April 2008, transcript 2310.20-29; Bates DW et al, "The costs of adverse drug events in hospitalised patients" (1997) 277(4) *Journal of the American Medical Association* 307, pp. 307-11. Each Adverse Drug Event increases the length of hospital stay by 2.2 days and the hospital cost by \$US 3,244. The figures are higher for preventable adverse drug events. The annual cost of preventable adverse drug events for a 700 bed teaching hospital would be \$US 5.6 million.
- ¹¹⁸ Submission of Margaret Duguid and Jenny Crane, 25 March 2008, SUBM.004.0142 at 147; Runy LA, "Emergency Department: Pharmacists in the ED help reduce errors" (2008) 82(3) *Hospital & Health Networks* 12, pp. 12-14, <http://www.hhnmag.com> (25 September 2008). In a quarter year study in 2007 at three EDs there were more than 2,200 pharmacist interventions with estimated savings of \$488,000, achieved through using lower cost medications, reduced length of stay and fewer re-admissions.
- ¹¹⁹ Meeting with the Society of Hospital Pharmacists of Australia, 27 June 2008.
- ¹²⁰ Associate Professor Peter Lipski, *The White Paper: A new direction for Geriatric Medical Services of the NSW Central Coast 2007*, 10 October 2008, provided with submission of Associate Professor Lipski, 3 March 2008, SUBM.011.0021.

-
- ¹²¹ Handler SM et al, " A systemic review of the performance characteristics of clinical event monitor signals used to detect adverse drug events in the hospital setting " (2007) 14(4) *Journal of the American Medical Informatics Association* 451, p. 451. Adverse drug events occur in 2.4-5.2 percent of hospitalised adult patients, increasing costs and the length of hospital stay. See also: Lada P and Delgado G Jr, "Documentation of Pharmacists Interventions in an Emergency Department and Associated Cost Avoidance" (2007) 64(4) *American Journal of Health System Pharmacy* 63, p. 66. In a 4 month study period, 2150 pharmacist interventions were documented, avoiding cost of around \$1,029,776. See also: Zed PJ et al, "Incidence, Severity and preventability of medication related visits to the Emergency Department: a prospective study" (2008) 178(12) *Canadian Medical Association Journal* 1563, p. 1563. Between 1995 and 2000, costs associated with adverse drug-related events rose from US\$76.6 billion to over US\$177.4 billion.
- ¹²² Australian Council for Safety and Quality in Health Care, *Second National Report on Patient Safety: Improving Medication Safety*, July 2002, Australian Council for Safety and Quality in Health Care, Canberra, p. 10, <http://www.safetyandquality.gov.au> (21 November 2008).
- ¹²³ Australian Council for Safety and Quality in Health Care, *Second National Report on Patient Safety: Improving Medication Safety*, July 2002, Australian Council for Safety and Quality in Health Care, Canberra, p. 17, <http://www.safetyandquality.gov.au> (21 November 2008).
- ¹²⁴ Theresa Beswick, Coffs Harbour Hospital hearing, 27 March 2008, transcript 1042.28-47.
- ¹²⁵ Confidential Coffs Harbour hearing, 27 March 2008, transcript 5.9-28.
- ¹²⁶ Jennifer Baroutis, Port Macquarie Hearing, 28 March 2009, transcript 1099.24-29.
- ¹²⁷ Dooley MJ et al, "A prospective multicentre study of pharmacist initiated changes to drug therapy and patient management in acute care government funded hospitals" (2004) 57(4) *British Journal of Clinical Pharmacology* 153, pp. 513-521.
- ¹²⁸ Dooley MJ et al, "A prospective multicentre study of pharmacist initiated changes to drug therapy and patient management in acute care government funded hospitals" (2004) 57(4) *British Journal of Clinical Pharmacology* 153, pp. 513-521. Clinical pharmacy intervention saved the lives of 1.1% of people admitted in the study. A further study of 14,315,506 hospital admissions from 864 American hospitals in 2006 supports the growth and value of clinical pharmacy services in hospitals: Bond CA and Raehl CL, "2006 National Clinical Pharmacy Services Survey: Pharmacy Services, Collaborative Drug Management Errors and Pharmacy Technology" (2008) 28(1) *Pharmacotherapy* 1.
- ¹²⁹ Meeting with the Society of Hospital Pharmacists of Australia, 27 June 2008.
- ¹³⁰ NSW Department of Health, *Annual Report 2006/07*, 2007, NSW Health, North Sydney, p. 217, http://www.health.nsw.gov.au/pubs/2007/pdf/AnnualReport_07.pdf (22 November 2008).
- ¹³¹ Bond CA and Raehl CL, "Special Article: Clinical Pharmacy Services, Hospital Pharmacy Staffing in Hospital Mortality Rates" (2007) 27(4) *Pharmacotherapy* 481.
- ¹³² Australian Council for Safety and Quality in Health Care, *National Inpatient Medication Chart Pilot Aggregate Data Report*, Undated, Australian Council for Safety and Quality in Health Care, Canberra, <http://www.safetyandquality.gov.au/internet/safety/publishing.nsf> (23 September 2008); Office of the Safety and Quality Council, *Final Report: Evaluation of the National Inpatient Medication Chart (NIMC) Pilot*, report prepared by Ipsos, 27 May 2005, Office of the Safety and Quality Council, p. 17, <http://www.safetyandquality.gov.au/internet/safety/publishing.nsf> (23 September 2008); Society of Hospital Pharmacists of Australia, *Position Statement: Clinical Pharmacists Improve Patient Outcomes*, August 2003, Society of Hospital Pharmacists of Australia, http://www.shpa.org.au/pdf/positionstatement/clin_pharm_ps_aug03.pdf (23 September 2008); Bond CA and Raehl CL, "2006 National Clinical Pharmacy Services Survey: Pharmacy Services, Collaborative Drug Management Errors and Pharmacy Technology" (2008) 28(1) *Pharmacotherapy* 1; Lada P and Delgado G Jr, "Documentation of Pharmacists' Interventions in an Emergency Department and Associated Cost Avoidance" (2007) 64(4) *American Journal of Health System Pharmacy* 63; Submission of the NSW Therapeutic Advisory Group, 23 May 2008, SUBM.045.0221.
- ¹³³ Confidential Coffs Harbour hearing, 27 March 2008, transcript 10.41-11.17; Confidential Liverpool hearing, 17 April 2008, transcript 16.12 –20.19.

-
- ¹³⁴ O'Leary KM and Allinson YM, "Pharmaceutical Review: Resource Implications for the Pharmacy Component in Australian Public Hospitals" (2006) 36(4) *Journal of Pharmacy Practice and Research* 291, p. 295.
- ¹³⁵ The Society of Hospital Pharmacists of Australia, "Standards of Practice for Clinical Pharmacy" (2005) 35(2) *Journal of Pharmacy Practice and Research* 122, p. 129.
- ¹³⁶ Karen Kennedy, Lismore hearing, 28 April 2008, transcript 2204.32-43.
- ¹³⁷ Confidential submission, 23 May 2008, SUBM.048.0069 at 70.
- ¹³⁸ Michael Holloway, Tweed Heads hearing, 29 April 2008, transcript 2310.31-40.
- ¹³⁹ Submission of Jonine Sinclair, Undated, SUBM.078.0046 at 47.
- ¹⁴⁰ For example, Michael Holloway, Tweed Heads Hospital Hearing, 29 April 2008, transcript 2310.31-40; O'Leary KM and Allinson YM, "Snapshot of the Australian Public Hospital Pharmacy Workforce in 2005" (2006) 36(2) *Journal of Pharmacy Practice and Research* 103, p. 103; O'Leary KM and Allinson YM, "Pharmaceutical Review: Resource Implications for the Pharmacy Component in Australian Public Hospitals" (2006) 36(4) *Journal of Pharmacy Practice and Research* 291, pp. 293-6. For New South Wales, approximately 252 full time equivalent pharmacists are required for basic clinical pharmacy services and approximately 451 for comprehensive clinical pharmacy services. pharmacy services and 451 for comprehensive clinical pharmacy services (Table 4).
- ¹⁴¹ O'Leary KM and Allinson YM, "Snapshot of the Australian Public Hospital Pharmacy Workforce in 2005" (2006) 36(2) *Journal of Pharmacy Practice and Research* 103, p. 104. Statistics from the 2007 workforce survey are currently being analysed by the Society of Hospital Pharmacists of Australia.
- ¹⁴² Dawn Astles, Royal North Shore Hospital hearing, 2 April 2008, transcript 1227.9-11.
- ¹⁴³ Karen Kennedy, Lismore hearing, 28 April 2008, transcript, 2205.47-2206.10.
- ¹⁴⁴ Michael Holloway, Tweed Hospital hearing, 29 April 2008, transcript 2311.16- 42.
- ¹⁴⁵ Submission of Terry Melocco, Gillian Campbell, Susan Welch, Maree Brown, 5 June 2008, SUBM.074.0013 at 16.
- ¹⁴⁶ Confidential submission, 23 May 2008, SUBM.048.0069 at 71; Michael Holloway, Tweed Heads hearing, 29 April 2008, transcript 2311.8-14; Submission of Directors of Pharmacy, NSW Teaching Hospitals, 12 March 2008, SUBM.015.0046 at 47-8; Margaret Duguid and Jenny Crane, 25 March 2008, SUBM.004.0142 at 0155-7; Margaret Duguid and Jenny Crane, 25 March 2008, SUBM.004.0142 at 0155.
- ¹⁴⁷ Submission of Terry Melocco, Gillian Campbell, Susan Welch and Maree Brown, 5 June 2008, SUBM.074.0013 at 17.
- ¹⁴⁸ Submission of the Pharmaceutical Society of NSW, 28 March 2008, SUBM.088.0093 at 98.
- ¹⁴⁹ Society of Hospital Pharmacists of Australia, *Strategies to improve the retention and recruitment of Australia's Hospital Pharmacy Workforce as part of the National Workforce Action Plan*, February 2007, Society of Hospital Pharmacists of Australia, Collingwood, http://www.shpa.org.au/pdf/whatsnew/NHWSF_response_200702.pdf (1 October 2008).
- ¹⁵⁰ Submission of Terry Melocco, Gillian Campbell, Susan Welch and Maree Brown, 5 June 2008, SUBM.074.0013 at 16.; Submission of Directors of Pharmacy, NSW Teaching Hospitals, 12 March 2008, SUBM.015.0046 at 0048.
- ¹⁵¹ Margaret Duguid Jenny Crane, 25 March 2008, SUBM.004.0142 at 0153.
- ¹⁵² Confidential Concord hearing, 24 April 2008, transcript 15.12-27.
- ¹⁵³ Directors of Pharmacy, NSW Teaching Hospitals, 12 March 2008, SUBM.015.0046 at 48.
- ¹⁵⁴ Dawn Astles and Sally Nicolson, Royal North Shore Hospital hearing, 2 April 2008, transcript 1227.45-1228.40.
- ¹⁵⁵ Dawn Astles and Sally Nicolson, Royal North Shore Hospital hearing, 2 April 2008, transcript 1228.37-1229.15; Karen Kennedy, Lismore hearing, 28 April 2008, transcript, 2205.24-42.
- ¹⁵⁶ Submission of Directors of Pharmacy, NSW Teaching Hospitals, 12 March 2008, SUBM.015.0046 at 48.
- ¹⁵⁷ Submission of Margaret Duguid and Jenny Crane, 25 March 2008, SUBM.004.0142 at 0153.

-
- ¹⁵⁸ Society of Hospital Pharmacists of Australia, "SHPA Standards of Practice for Clinical Pharmacy" (2005) 35(2) *Journal of Pharmacy Practice and Research* 122, p. 129.
- ¹⁵⁹ Confidential submission, 23 May 2008, SUBM.048.0069 at 71.
- ¹⁶⁰ Part A Clause 1 (xxxiii-xxxvi), *Health Employees' (State) Award (NSW)*, http://www.health.nsw.gov.au/resources/jobs/conditions/awards/pdf/hsu_he_state.pdf (22 November 2008).
- ¹⁶¹ Section 51(xxiiiA), *Commonwealth of Australia Constitution Act 1900 (Cth)*.
- ¹⁶² Commonwealth Department of Health and Ageing, PBS for Consumers website, <http://www.pbs.gov.au/html/consumer/pbs/about> (2 October 2008).
- ¹⁶³ Commonwealth Department of Health and Ageing, Data and Modeling Section Pharmaceutical Policy and Analysis Branch, *PBS Expenditure and Prescriptions: Twelve Months to 30 June 2007*, 2008, Commonwealth Department of Health and Ageing, Canberra, Summary, <http://www.health.gov.au/internet/main/publishing.nsf> (29 August 2008).
- ¹⁶⁴ Commonwealth Department of Health and Ageing, Data and Modeling Section, Pharmaceutical Policy and Analysis Branch, *PBS Expenditure and Prescriptions: Twelve Months to 30 June 2007*, 2008, Commonwealth Department of Health and Ageing, Canberra, p. 3, <http://www.health.gov.au/internet/main/publishing.nsf> (29 August 2008).
- ¹⁶⁵ Commonwealth Department of Health and Ageing, Data and Modeling Section, Pharmaceutical Policy and Analysis Branch, *PBS Expenditure and Prescriptions: Twelve Months to 30 June 2007*, 2008, Commonwealth Department of Health and Ageing, Canberra, Summary, <http://www.health.gov.au/internet/main/publishing.nsf> (29 August 2008).
- ¹⁶⁶ Commonwealth Department of Health and Ageing, Data and Modeling Section, Pharmaceutical Policy and Analysis Branch, *PBS Expenditure and Prescriptions: Twelve Months to 30 June 2007*, 2008, Commonwealth Department of Health and Ageing, Canberra, p. 4, <http://www.health.gov.au/internet/main/publishing.nsf> (29 August 2008).
- ¹⁶⁷ Commonwealth Department of Health and Ageing, Data and Modeling Section Pharmaceutical Policy and Analysis Branch, *PBS Expenditure and Prescriptions: Twelve Months to 30 June 2007*, 2008, Commonwealth Department of Health and Ageing, Canberra, p. 4, <http://www.health.gov.au/internet/main/publishing.nsf> (29 August 2008).
- ¹⁶⁸ Commonwealth Department of Health and Ageing, Data and Modeling Section Pharmaceutical Policy and Analysis Branch, *PBS Expenditure and Prescriptions: Twelve Months to 30 June 2007*, 2008, Commonwealth Department of Health and Ageing, Canberra, Summary, <http://www.health.gov.au/internet/main/publishing.nsf> (29 August 2008).
- ¹⁶⁹ Submission of Pharmaceutical Society of NSW, 28 March 2008, SUBM.088.0093 at 97; Submission of Peter Rankin, 2 April 2008, SUBM.014.0014 at 24.
- ¹⁷⁰ Submission of Professor Carol Pollock, 29 May 2008, SUBM.070.0224 at 226.
- ¹⁷¹ Confidential Liverpool hearing, 17 April 2008, transcript 19.3-19; Karen Kennedy, Lismore hearing, 28 April 2008, transcript 2206.20-2207.11; Michael Holloway, Tweed Heads hearing, 29 April 2008, transcript 2313.31-2314.11.
- ¹⁷² Ann Stublely, Sydney Children's Hospital hearing, transcript 3032.29-39; Submission of the Australian Medical Association and Australian Salaried Medical Officers' Federation, 28 March 2008, SUBM.016.0015 at 50; Dawn Astles, Royal North Shore Hospital hearing, 2 April 2008, transcript 1230.19.
- ¹⁷³ Sally Nicolson, Royal North Shore Hospital hearing, 2 April 2008, transcript 1231.47-1232.6.
- ¹⁷⁴ Ann Stublely, Sydney Children's Hospital hearing, 19 May 2008, transcript 3031.44-3032.24.
- ¹⁷⁵ NSW Health, *Medication Handling in NSW Public Hospitals Policy*, PD2007_077.
- ¹⁷⁶ Dawn Astles, Royal North Shore Hospital hearing, 2 April 2008, transcript 1230.14-1235.45.
- ¹⁷⁷ Dawn Astles, Royal North Shore Hospital hearing, 2 April 2008, transcript 1230.14-1235.45.
- ¹⁷⁸ NSW Health, *Outpatient Pharmaceutical Changes and Safety Net Arrangements Policy*, PD2008_003.

-
- ¹⁷⁹ Letter from NSW Health dated 17 October 2008; NSW Health, *Outpatient Pharmaceutical Charges and Safety Net Arrangements Policy*, PD2008_003.
- ¹⁸⁰ NSW Health, *Outpatient Pharmaceutical Charges and Safety Net Arrangements Policy*, PD2008_003.
- ¹⁸¹ NSW Health, *Outpatient Pharmaceutical Charges and Safety Net Arrangements Policy*, PD2008_003.
- ¹⁸² Submission of Directors of Pharmacy, NSW Teaching Hospitals, 12 March 2008, SUBM.015.0046 at 47.
- ¹⁸³ Submission of Graeme Kershaw, 4 April 2008, SUBM.009.0230 at 230.
- ¹⁸⁴ Confidential hearing at the Inquiry's offices via video link from Tweed Heads, 29 May 2008, transcript 7.6-10.
- ¹⁸⁵ Dawn Astles and Sally Nicolson, Royal North Shore Hospital hearing, 2 April 2008, transcript 1230.31-40.
- ¹⁸⁶ Submission of the Pharmaceutical Society of Australia, 28 March 2008, SUBM.088.0093 at 97.
- ¹⁸⁷ Australian Government, Medicare Australia website, "PBS Prescriptions in public hospitals", <https://www.hic.gov.au/provider/pubs/mediguide/section7/hospital-prescription.shtml> (2 October 2008); Medicare Australia, *Mediguide: A guide to Medicare and other Medicare Australia health programs*, 2007, Medicare Australia, p. 71.
- ¹⁸⁸ Government of South Australia, Department of Health, "Pharmaceutical Reforms", <http://www.safetyandquality.sa.gov.au/Default.aspx?tabid=104> (2 October 2008); Government of South Australia, Department of Health, Pharmaceutical Reforms Newsletter, Issue 4, September 2008.
- ¹⁸⁹ Meeting with the Society of Hospital Pharmacists of Australia, 27 June 2008.
- ¹⁹⁰ Australian Government, Medicare Australia website, "The PBS and you", <https://www.hic.gov.au/provider/pbs/education/pbs-and-you/index.shtml> (2 October 2008).
- ¹⁹¹ Meeting with the Society of Hospital Pharmacists of Australia, 27 June 2008.
- ¹⁹² Australian Government, Medicare Australia website, "Pharmacy claiming" <https://www.hic.gov.au/provider/pubs/mediguide/section7/claiming.shtml> (3 October 2008).
- ¹⁹³ Australian Government, Medicare Australia website, "Pharmacy claiming" <https://www.hic.gov.au/provider/pubs/mediguide/section7/claiming.shtml> (3 October 2008).
- ¹⁹⁴ *Australian Health Care Agreement between the Commonwealth of Australia and the State of New South Wales 2003-2008*.
- ¹⁹⁵ *Australian Health Care Agreement between the Commonwealth of Australia and the State of Queensland 2003-2008*; *Australian Health Care Agreement between the Commonwealth of Australia and the State of Victoria 2003-2008*.
- ¹⁹⁶ Government of South Australia, Department of Health, South Australia Health Department. Pharmaceutical Reforms Newsletter, Issue 3, May 2008.
- ¹⁹⁷ The Society of Hospital Pharmacists Bulletin March 2007 http://www.shpa.org.au/pdf/publications/bulletin_mar07.pdf (7 October 2008).
- ¹⁹⁸ See section 85, *National Health Act 1953* (Cth) for definition of pharmaceutical benefits.
- ¹⁹⁹ Section 94(2), *National Health Act 1953* (Cth).
- ²⁰⁰ Medicare Australia website, "Hospital Authority", <http://www.medicareaustralia.gov.au/provider/pbs/supplier/hospital.jsp> (1 September 2008).
- ²⁰¹ Letter from NSW Branch of Society of Hospital Pharmacists of Australia to Special Commission of Inquiry, 10 September 2008.

10 Education & training

Importance of education & training	322
Postgraduate medical training in NSW public hospitals	325
NSW Institute of Medical Education and Training.....	325
The role of the medical colleges in education & training.....	333
Doctors	335
No protected time	335
Looking after teachers.....	336
Teaching the teacher.....	339
Nurses	340
Continuing education and training.....	340
Solutions.....	345
Lack of career path for nurse educators.....	346
Allied health	347
Use of technology	348
Simulation technology.....	348
Video conferencing and online training.....	349
Inter-disciplinary training	349

- 10.1 In this chapter, I will examine the education and training opportunities provided to doctors, nurses and allied health professionals in NSW public hospitals, and suggest how this could be substantially improved.
- 10.2 Education and training is another area where there is overlap between the state and commonwealth governments.
- (a) The Commonwealth Government provides and substantially funds undergraduate education of health professionals at universities and tertiary institutions.
 - (b) The State Government provides pre-vocational training, including placements and on-site education for trainee medical specialists, undergraduate medical students and nurses.
 - (c) Medical colleges provide specialist education, partly funded by the Commonwealth government and partly funded by the doctors in training.

Importance of education & training

- 10.3 The provision of proper education and training to clinicians is vital to the functioning of NSW public hospitals for, essentially, 4 reasons:
- (a) to constantly achieve a high standard of patient care;
 - (a) to ensure the safety of patients;
 - (b) to ensure that medical treatment is delivered in the most sensible and efficient manner; and
 - (c) to attract and retain the workforce.
- 10.4 Many clinicians submitted to the Inquiry that the health system cannot work effectively unless there is an overt commitment to supervision, education and training of junior clinical staff . They said that these areas should be regarded as integral to health service delivery despite the fact that the benefits of education and training appear to be intangible¹. They sought to highlight that education and training can and should rightfully be regarded as an investment in the health system, rather than a cost.
- 10.5 The majority of the submissions to the Inquiry about education and training of clinicians related to doctors' training, as opposed to education and training for the nursing and allied health professions. There were many other submissions which also highlighted the importance of education and training in these areas and I deal with them further below.
- 10.6 The Inquiry received a large number of submissions to the effect that ongoing education and training has a direct relationship with the quality of care. With regard to medical education and training, I was told that, in addition to its direct benefits for the quality of the medical workforce and patient care, medical education and training is an invaluable tool to increase the interaction between senior and junior doctors and to promote a level of communication between them that would otherwise not exist².
- 10.7 I was told that, in reality, teaching and education is given a low priority in hospitals, in terms of funding, time and facilities because NSW Health does not regard it as "core business". I received numerous submissions that increased demands on clinicians to focus on service delivery have meant that education and training are no longer an integral part of medical practice in public hospitals.

- 10.8 The Inquiry was given the following examples which are said to demonstrate the low priority given to teaching and education:
- The resources provided relative to the size of the training and education requirements for junior medical officers are very limited³;
 - Teaching and education facilities are given low priority compared to clinical space⁴;
 - Medical staff are expected to fund a lot of their own education and training⁵;
 - Training and education tend to take place during discretionary time⁶;
 - Funding for education is the first thing to be cut when budgets are exceeded⁷;
 - Training, with its intangible benefits, is awarded lower priority than acquisition of new equipment or staffing and direct clinical services⁸;
 - Any teaching of junior medical officers tends to be informal or, if formal, health workers only attend if they are able as service work takes precedence⁹;
 - Hospitals leave it entirely to junior medical officers to resolve the tension between their training needs and patient demands. This results in education not being attended to and junior doctors working unrostered and unpaid overtime¹⁰;
 - The responsibility for the welfare and co-ordination of junior medical officers is under-resourced as it falls to too few staff relative to the number of junior medical officers and the geographical spread of the area health services. As a consequence, the staff are too busy to be informed of issues affecting junior medical officers, much less to act on them¹¹.
- 10.9 I was told that hospitals which have a poor reputation for education and training fail to attract staff at both junior and consultant level¹². By way of contrast, the Inquiry was told that Flinders Medical Centre in South Australia has been shown to have a far superior recruitment and retention rate than other comparable hospitals because it has a dedicated medical education and training unit¹³.
- 10.10 The position seems to me to be even more difficult in rural areas. The Inquiry received submissions that the distribution of postgraduate training infrastructure outside the metropolitan centres is not equitable. This infrastructure consists of physical infrastructure, for example lecture theatres and clinical skills facilities, and the administrative infrastructure, including support staff, allocated time and funding for clinical teachers¹⁴.
- 10.11 I was told by many senior doctors that a positive experience in the early years of medical training is an important factor in a young doctor's decision about where to practise medicine, in both a geographic and professional sense. I was told that a positive training experience in a rural hospital is important to attract trainees back to the hospital at which they trained¹⁵. There is reportedly evidence that rural-based medical students are 2.5 times more likely to remain working in a rural area¹⁶. Protected teaching time at rural hospital is therefore particularly important.
- 10.12 It is absolutely clear to me that there is a culture of service delivery in most hospitals that does not value teaching and education and that effort needs to be made to overcome this culture. The current system for education and training, which is largely opportunistic and ad hoc, will only become more difficult to sustain as hospitals become busier, and in the area of medical education, the number of medical graduates increases.
- 10.13 It was submitted to the Inquiry, and I accept, that one of the main reasons that education and training tends to be given low priority is that it is not included among the criteria against which the performance of area health services is assessed¹⁷. The Inquiry has examined the Performance Agreements between NSW Health and area

health services applying in 2007/2008¹⁸. Although the agreements contain important criteria for the improvement of patient care, there are no goals which relate to education and training. It is unsurprising that medical education and training is given little priority in circumstances where the performance of health service managers is assessed against aspects of direct clinical care and budget compliance.

- 10.14 In my view, a useful tool to enhance the importance of education and training in NSW public hospitals is to introduce a high level performance requirement for hospital management relating to education and training. Until there are meaningful performance assessments that require hospital management to deliver education and training, education and training will continue to be undervalued because of its intangible benefits. There is in my view a need for senior administrative staff (Chief Executives, General Managers and other health service managers) to be given a role in managing the conflict between education and training and service provision. In other words, training needs to be part of the public health system's core business.

Recommendation 30: *Benchmarks which adequately measure the extent of the delivery of postgraduate clinical education and training should be included in performance agreements between NSW Health and area health services and statutory health corporations.*

Research

- 10.15 I was told that research fares even worse than education and training when it comes to prioritising hospitals' service requirements. Senior clinicians are concerned by a decreasing emphasis on, and support for, the pursuit of excellence with a consequent decline in a clinician's capacity to do research¹⁹. I was told that this contributes to a loss of talented people from the public system.

- 10.16 Clinicians say that clinical research develops excellence in clinical care and clinical improvement. I was told that²⁰:

"60 per cent of advances in clinical care can be ascribed to biomedical research that has come out of institutes here or anywhere else around the world"

"There is absolutely no doubt that clinical research underpins evidence based medicine. ... if you invest a dollar in clinical research then you get \$8 back"

"The first thing to point out is that research is often regarded by many as a frill or a cost or an intangible rather than an essential component of a research and teaching hospital."

"I think one of our cardiologists once said, "Everything I now do has been research in the past ten to 15 years," and obviously always clinical care is an evolving process and that evolution is guided by the injection of research based facilities."

- 10.17 I heard that there is no "champion" for research in NSW Health and insufficient funding for research. For example, one witness stated²¹:

"We, in our department, feel very strongly that our ability to cure patients' leukaemias, lymphomas and other blood cancers is entirely due to the conduct of clinical trials that have gone before us. Yet we have to do our own fund-raising to get sufficient staff in for our clinical trials unit, because it's not considered core business and is insufficiently funded by NSW Health."

10.18 I appreciate how important research is to achieving advances in medicine and patient care. Indeed, research and development are, together with training and education, specified as functions of area health services under the *Health Services Act 1997*:

"(l) to provide training and education relevant to the provision of health services,

(m) to undertake research and development relevant to the provision of health services"

10.19 Nevertheless, it is not within my terms of reference to make recommendations about the provision of funding or other support for research.

Postgraduate medical training in NSW public hospitals

10.20 I heard evidence, which accorded with my own observations, that the system of postgraduate medical education and training²² has not developed as a well planned and coordinated system but is rather fragmented. The training system for medical graduates is complex and seems to take a very long time.

10.21 Across Australia, there are presently 12 colleges and about 62 training programs, each with their own training requirements and thousands of clinician teachers operating in hundreds of health service facilities, two levels of government and the public and private sectors²³.

10.22 There are two principal entities involved in postgraduate medical training, which I will examine in turn.

NSW Institute of Medical Education and Training

10.23 The role of IMET is to support area health services in relation to postgraduate medical education and training for pre-vocational doctors, develop systems and processes to enable the distribution of medical training positions in a manner aligned with service needs and develop postgraduate medical training networks and other training support infrastructures. IMET's philosophy is to ensure that wherever trainees are working, they receive optimum supervision and training.

10.24 IMET informed the Inquiry that before brokering any aspect of medical training, it liaises with all of the groups involved in, or which have an interest in, the delivery of medical education and training²⁴. These include the Colleges, the area health services and hospitals, the universities, the New South Wales Medical Board, the Rural Institute of Clinical Services and Training and other relevant bodies, such as the Greater Metropolitan Clinical Taskforce and the Clinical Excellence Commission²⁵.

10.25 There are about 2,600 doctors participating in training networks established by IMET including²⁶:

- (a) 615 interns, called PGY1 (post-graduate year 1) and 866 PGY2, collectively referred to as the prevocational training network;
- (b) 369 in the basic physician training network, of which 92% are College trainees;
- (c) 162 in the basic surgical training network;
- (d) 333 in the psychiatry training network of which 59% are College trainees;
- (e) 220 in the paediatrics training network; and

- (f) 50 in the cardiology training network.
- 10.26 A network is a group of training sites, usually hospitals, linked for the purposes of providing training and delivering medical services across the group. The intention of networked training is to facilitate an appropriate distribution of trainees in each network and across networks while optimising the quality of the training available at each site. In particular, I was told that linking metropolitan, outer metropolitan and rural hospitals together helps to ensure that the rural and outer metropolitan hospitals receive a fair allocation of trainees and are not obliged to bear the brunt of medical workforce shortages²⁷.
- 10.27 IMET is also implementing the Hospital Skills Program which is a training program for doctors who do not join a College training program. I discuss this in Chapter 7.
- 10.28 The structures through which IMET operates vary according to the area of training. IMET oversees the networks for each specialty program through State Training Councils which bring together NSW Health, the relevant Colleges, area health service representatives, clinicians and trainees to oversee the delivery of training at a State-wide level²⁸.
- 10.29 Each network also has a Network Governance Committee which is responsible for the delivery of training within the network (including workforce distribution across the hospitals in the network) and a Network Director of Training. There are also site directors of training in each hospital.
- 10.30 The role of the Prevocational Training Council is to ensure State-wide coordination of the prevocational training networks and develop resources which will improve prevocational training in NSW. The Council also provides expert advice to IMET and NSW Health on prevocational matters and relevant issues. Each network has a Network Committee for Prevocational Training (NCPT) which is responsible for coordinating education and training across the hospitals within the network. There is a Director of Prevocational Education and Training in each hospital who is a full time clinician²⁹. This role includes the obligation to address any issues which arise with respect to the prevocational doctor's professional practice, which I was told can create a large workload. By and large, a Director of Prevocational Education and Training is not paid for the duties associated with this role which are additional to his or her clinical workload.
- 10.31 IMET's training networks do not currently marry up with the area health service boundaries. I was told that the area health services are currently far too big to be effective in terms of education and training. As a consequence, some area health services deal with anywhere between 4 and 7 different networks.
- 10.32 I was told that some colleges have resisted IMET's role in education and training, on the basis that IMET is regarded as taking over the colleges' role. IMET has conducted a number of reviews of the delivery of specialist training in New South Wales, including anaesthetics, advanced cardiology training, psychiatry, and made recommendations to improve the structure, organisation and management of those areas of specialist training in New South Wales. In addition to the networks which already function, IMET has proposed formal networks of training for other areas of specialty, including anaesthetics, radiology and emergency medicine. I was told that it is difficult with certain colleges to permeate professional boundaries which are firmly entrenched.

Funding for postgraduate training provided by IMET

- 10.33 The NSW Health budget does not allocate any separately identified amount for medical education and training.
- 10.34 IMET informed the Inquiry that NSW Health has calculated that approximately 5% of the total health budget is allocated to teaching and research generally.³⁰ This equates to approximately \$555 million. However, it is not clear to me what the component parts of this total sum is, nor is it at all clear how this money is allocated.
- 10.35 I was informed by IMET that it is allocated about 2% of this sum, that is \$7.25 million plus \$4.1 million for its organisational costs. These costs support prevocational, vocational and non-specialist training, but not capital expenditure or facility costs³¹.
- 10.36 IMET provided the Inquiry with a costing of a comprehensive system for the delivery of postgraduate medical education and training in NSW. Its costing is indicative only, being based on an extrapolation of 2008 costs, and does not include capital expenditure for the introduction of new infrastructure. I discuss this below.

Accreditation of hospitals for pre-vocational training

- 10.37 All hospitals that employ prevocational (PGY1 and PGY2) doctors in NSW, and all terms to which prevocational doctors are allocated, must be accredited by IMET in accordance with defined standards. There are presently 53 accredited hospitals and health organisations in NSW.³² These hospitals and health organisations are grouped together into 15 Prevocational Training Networks³³. IMET allocates eligible graduates to one of these networks.
- 10.38 The accreditation process has several key steps:
- a pre-accreditation survey completed by the hospital;
 - a visit by an IMET-appointed accreditation team;
 - a comprehensive report on the application of standards within the hospital
- 10.39 IMET's accreditation team generally consists of between 3 to 5 surveyors who visit each hospital for 2 days. The surveyors are not paid. A senior representative of IMET is running out of doctors to act as surveyors who accredit hospitals for training.
- 10.40 If all standards are met, the hospital is awarded accreditation for up to three years. If standards are not met, IMET will prepare recommendations for meeting the criteria and the award of accreditation will be dependent on compliance with standards.
- 10.41 IMET's Accreditation Standards require hospitals to:
- (a) ensure pre-vocational trainees have appropriate knowledge, skills and supervision to provide quality patient care;
 - (b) provide a wide range of education and training opportunities for pre-vocational trainees to ensure that they are competent and safe; and
 - (c) promote the welfare and interests of pre-vocational trainees.
- 10.42 A number of standards support each goal. To fulfil the goal a hospital must comply with the objectives defined in the standard.
- 10.43 As discussed in Chapter 13, one of IMET's Accreditation Standards relates to supervision. IMET informed that Inquiry that it does not have any specific powers to make hospitals accountable for any deficiencies in supervision arrangements with regard to junior medical officers. It can however impose conditions on a hospital's

accreditation, in the form of provisos, relating to specific deficiencies which the hospital is required to address satisfactorily within a stated period of time.

- 10.44 Between 2004 and 2007, 25 of the 53 hospitals received commendations and 39 hospitals had provisos attached to their accreditation as follows:
- (a) inadequate trainee representation and advocacy (12 hospitals);
 - (b) inadequate supervision (11 hospitals);
 - (c) inadequate organisational structures for managing junior medical officers (18 hospitals);
 - (d) inadequate “effective” clinical teaching (8 hospitals); and
 - (e) inadequate term orientation (5 hospitals).
- 10.45 IMET informed the Inquiry that it has accredited a total of 800 terms to which prevocational doctors can be allocated in accredited hospitals. Each term is generally 10 to 11 weeks in duration. Prevocational doctors have to complete 5 terms covering 5 areas of practice of which general surgical, general medicine and emergency medicine are compulsory in PGY1.
- 10.46 Often, junior doctors have to travel to different hospitals to complete their terms. Some junior doctors told the Inquiry that the length of terms is too short to allow them to familiarise themselves with the hospital and speciality with which the term is concerned³⁴. It is also said that the networking of medical training positions across several hospitals has a tendency to erode junior doctors’ sense of institutional loyalty and that this can erode morale³⁵. Submissions were made to the Inquiry that a ‘hub and spoke’ model of training ought to be adopted, rather than the networking model. I discuss these submissions in Chapter 6. It seems to me that the delivery of training across networks is in principle an effective way to ensure that there is an equitable distribution of workforce across the State.
- 10.47 The appropriate length of the terms required to be undertaken by prevocational doctors is not a matter that I consider to be within the terms of reference.

Assessment of interns

- 10.48 IMET has established a system for monitoring the performance of interns. IMET’s accreditation standards for PGY1 and PGY2 placements require that supervisors undertake assessments of trainee performance using a standardised form during each of the 5 terms each year undertaken by PGY1 and PGY2 doctors. Interns are assessed mid-term and at the end of the term.
- 10.49 Satisfactory assessments by PGY1 doctors are a prerequisite for general registration with the Medical Board. The Inquiry was informed that these assessments are completed with a high degree of compliance but that the rate of reported completion of PGY2 assessments is lower and varies across sites³⁶.
- 10.50 Again, the system relies on the goodwill of senior doctors who conduct the assessments, without additional remuneration for what can be a huge workload in metropolitan hospitals³⁷. Whilst this is admirable, it does limit, to some extent, the degree to which senior doctors can dedicate themselves to the task of adequately assessing interns’ performance.
- 10.51 IMET indicated to me that the current system for assessing the performance of interns is by and large effective in identifying when interns perform badly. It said, however, that

it is not very effective in identifying what the nature of any weakness in performance may be³⁸.

- 10.52 The Inquiry received evidence about the assessment process from a number of junior doctors. Those who spoke to the Inquiry generally considered the current system to be inadequate. I was told that a mid-term and end of term assessment by the supervisor is insufficient for discussing and resolving any day-to-day issues that an intern may have³⁹. It is said that the effectiveness of the process depends upon the supervisor's interest and engagement with the process and that there is no mechanism for the intern to formally evaluate the performance of the supervisor⁴⁰. Where the supervisor is a Visiting Medical Officer, as opposed to a Staff Specialist, the intern's contact with the person may be limited to 30 minutes per week over a 10 week term⁴¹. Some doctors feel that there should be a system for identifying ineffective supervisors⁴².
- 10.53 Junior doctors told the Inquiry that unless they fail their term assessments, there is no avenue for receiving assistance from "anybody else within the structure"⁴³. They see the quality of supervision and training provided to them, and of the assessment provided to them, as dependent entirely on the supervisor's dedication to the task. Numerous doctors, both junior and senior, advocated that a formal process for feedback to prevocational doctors be implemented. Many also support a system of upward appraisal of registrars and consultants who supervise them⁴⁴.
- 10.54 It appears to me that the present system of monitoring interns is somewhat rudimentary, in that it is not sufficiently resourced to do more than identify interns who are doing badly. It does not provide additional support and feedback for those who are doing well or could be doing better. The Inquiry received evidence that there is not always capacity in the system to provide interns with appropriate feedback. Nor is there capacity to remove an intern from a term if they are not coping well, due to the shortage of medical staff and tight rostering. It was stated in this way by one doctor who gave evidence⁴⁵:
- "... there is no fat in the system to allow for those who are starting to crumble to be supported".
- 10.55 I was told that the only real recourse available to a hospital when an intern does not perform to a reasonable standard is to delay their registration by not giving an assessment of satisfactory performance during the terms⁴⁶. This, I was told, is only done in extreme cases. IMET informed the Inquiry that over the last 2 years, between 0.5 and 1% of graduates of Australian medical schools failed to complete the requirements of internship within one year⁴⁷. I was told that there is sometimes an incentive to pass a poorly performing intern in order to move them through to the next term and away from one's department⁴⁸.
- 10.56 It seems that some mechanisms already exist for eliciting feedback from interns or residents about the quality of the education and training they receive. IMET Accreditation Standards require that a training site (that is, a hospital) demonstrate that it seeks feedback from trainees on a range of issue, including education, training activities, workload and welfare⁴⁹. However, there are no consistent mechanisms across area health services for ensuring compliance with this accreditation standard. Certainly the evidence received by this Inquiry indicates that junior doctors are generally not receiving regular feedback about their performance and that they would like such a system to be introduced. There are of course exceptions.
- 10.57 Perhaps the best system for the supervision and assessment of interns that I heard about during the course of the Inquiry was at Tamworth Hospital⁵⁰. At that hospital, a 'junior medical officer education officer' who is an experienced nurse organises term

assessments and education activities for junior medical officers and offers support and education where required. The education officers fulfil that role on a 0.6FTE basis. This is overseen by a Visiting Medical Officer, who is paid to attend the hospital for half a day each week to ensure that supervision is progressing well.

- 10.58 Dr Finlayson, Director of Medical Services at Tamworth Hospital, gave evidence that the programme for interns at Tamworth aims to identify, by the end of the second term, any issues relating to an intern's performance and to work through those issues with the JMO education officer and outside services if needed. A remediation programme is established if appropriate. Interns are given feedback at the beginning of term as to what is expected, in the middle of term to see how they are progressing, and at the end of term. Dr Finlayson gave evidence that this program of supervision has worked well and that the Medical Board has on occasion requested the hospital to take on interns who have failed elsewhere for assessment or remediation⁵¹.

Conclusion and proposals for improvement

Page 330

- 10.59 The establishment of IMET has clearly improved the coordination of prevocational medical training in New South Wales. However, IMET considers that the systems and structures required to ensure that there is quality medical education and training within each training site can and should be improved.
- 10.60 At the Inquiry's request, IMET provided the Inquiry with an indicative costing of a comprehensive system for the delivery of postgraduate medical education and training in NSW. The annual costing for the comprehensive structure would be \$79 million if introduced in its entirety in 2008. IMET stated that this would increase to approximately \$149 million by 2014 taking into account CPI and the increasing number of graduates. Many of the systems and structures that IMET proposes are reflected in the discussion in this chapter about the need for more support to the senior doctors who fill education and training roles.
- 10.61 Set out below is a summary of the main items included in IMET's costing. IMET says that the delivery of postgraduate medical education and training in NSW should be improved by:

At the training site (hospital) level:

- (a) Establishing a Clinical Education and Training Unit (**CETU**) in each training site (that is, hospital, clinic or other training setting accredited by IMET for post-graduate training). The role of the CETU would be to provide leadership, support and accountability for education and training at the site level. It would be a 'shop-front' for all education and training issues within each teaching (hospital) site;
- (b) Introducing a sliding scale for payment of site directors of training, depending on the size of the training program (number of trainees) and the estimated number of sites;
- (c) Creating a new role of Staff Specialist Medical Education and Training for senior clinicians who provide additional on-the-job clinical education and training for junior doctors.
- (d) Providing funds for high quality, regular and relevant educational initiatives at each training site, including Simulation Centres.

At the training network level:

- (a) Introducing assessment and feedback models for each training program which recognises the time spent on performance assessments by supervisors;

- (b) Providing funds to ensure that the time spent by Network Directors of Training to oversee and plan the coordination of training within their network is protected;
- (c) Introducing education support officers who support the work of the Network Directors of Training;
- (d) Using Network Governance Committees to provide oversight to the network training program and provide the opportunity to bring relevant people together to develop the network training program.

At the area health service level:

- (a) Establishing Committees for Postgraduate Education and Training (**CPET**) in each Area Health Service and a Chair of each CPET who has protected time to provide leadership in the area health service-wide delivery of training programs. IMET informed the Inquiry that it is currently working with Area Health Services to establish the proposed CPETs (this item was therefore not included in IMET's costing). Each CETU would report to the CPET in its area health service;
- (b) Having a Manager for Postgraduate Medical Education and Training who supports the Chair of the CPET and provides leadership and accountability for the functions of the CPET, support to medical staff for access to cross-discipline training and professional development programs such as Training on the Run and programs offered through area health service Learning and Development Units;
- (c) Providing support for International Medical Graduates, including appointing a clinician in each area health service to offer specific support to the International Medical Graduates and AMC graduates and a Medical Education Officer to support the coordination of their specific educational activities, including proposed tutorials on communication.

Page 331

At a State level:

- (a) Providing funds to allow the Chair of each training program's State Training Council to have 'protected' time for carrying out the duties of that position. The funds provide backfill (that is, other staff to cover the Chair's clinical workload) or an allowance to the Chair.
- (b) Introducing an AMC graduate pre-employment program twice a year, including payment for relevant facilitators, to facilitate smooth transition into the NSW public hospital system;
- (c) Introducing a Leadership Development Program for trainees consisting of 2 face-to-face education sessions and 2 training forums, with the aim of developing future clinical leaders;

For IMET:

- (a) Provision of funds to support the accreditation process including administrative support for accreditation visits and payments to survey team members;
- (b) Providing funds to IMET as there are resource implications of its increased oversight and support for the delivery of postgraduate training programs in NSW.

10.62 IMET says that the cost of providing a robust system of medical education and training which is not reliant on goodwill alone (as it is presently the case) will be far outweighed by the benefits to patient care. It will lead to significant clinician engagement at all levels and ensure excellent supervision and medical training.

- 10.63 I make some specific recommendations below which reflect many of the initiatives that IMET has proposed.
- 10.64 IMET also provided to the Inquiry a draft policy which it sent to NSW Health for consideration in 2007 outlining its roles and responsibilities and the roles and responsibilities of area health services in the delivery of postgraduate medical education⁵².
- 10.65 The draft policy specifies IMET's functions (largely as described in this chapter) and some additional functions, such as:
- IMET would establish workload benchmarks for equitable workforce distribution of interns, Australian Medical Council graduates, residents and networked specialist training programs supported by IMET;
 - IMET would set medical workforce distribution benchmarks according to an identified process established and maintained in conjunction with relevant public health organisations;
 - IMET would acquire detailed data from NSW Health and other "relevant groups and individuals" on the number and type of medical training positions in area health services and areas of workforce shortage as indicated by vacant positions, with the ultimate goal of developing effective systems for the equitable distribution of postgraduate trainees.
 - In consultation with Colleges, IMET would periodically review Colleges' specialty training programs within area health services and support Site Directors of Training through the provision of resources, information, advocacy and recognition.
 - IMET would be able to recommend to NSW Health the withdrawal of specific funding from area health services who fail to meet specified objectives and indicators.
- 10.66 The policy includes directives that area health services:
- provide appropriate support and supervision for clinical training;
 - comply with IMET's decisions about accreditation and workforce distribution benchmarks;
 - provide workforce data;
 - not employ postgraduate year 1 and 2 doctors unless the positions are accredited by IMET;
 - allow employees to participate in IMET accreditation survey teams during paid working time
- 10.67 This draft policy addresses many of the issues that IMET made submissions to the Inquiry about and which it considers to be challenges to its present operations. I agree with the principle of establishing a policy clearly identifying the ambit of area health services' roles and responsibilities when it comes to delivering, and supporting the delivery of, education and training. I also agree that IMET's task would be facilitated if it were to have access to robust workforce data showing where areas of workforce shortage exist to enable an equitable distribution of doctors.
- 10.68 I make recommendations at the end of this chapter about the introduction of an interdisciplinary training program for prevocational doctors, junior nurses and allied health staff where appropriate. This would see IMET replaced by the NSW Institute for Clinical Education and Training. The proposal put forward by IMET which is outlined above is one system that could readily be implemented to support the delivery of postgraduate training along the terms I have in mind.

Recommendation 31: *NSW Health should review, develop if required and implement such policies as will clearly specify the roles and responsibilities of the Institute of Clinical Education and Training and the roles and responsibilities of area health services and relevant statutory health corporations in the delivery of training and education relevant to health services.*

The role of the medical colleges in education & training

- 10.69 I discussed the role of medical colleges generally in Chapter 7.
- 10.70 The Inquiry received submissions to the effect that vocational trainees (that is, registrars) experience the same problems as prevocational doctors in attending training and education sessions because they are busy meeting the demands of their clinical workloads.
- 10.71 It was also widely submitted that senior medical staff (that is, Staff Specialists and Visiting Medical Officers) are overburdened with clinical and non-clinical workloads associated with the hospital's service requirements such that they have little time to devote to training and supervising registrars and junior medical officers⁵³. One submission made the point that this is in contravention of Colleges' accreditation criteria⁵⁴.
- 10.72 The role of colleges in the training of doctors is far from uniform. It is not proposed to canvass the training provided by each College as I regard this as outside my terms of reference. It is clear, however, that aspects of this training are integrated with, and affect, the delivery of acute care services.

Page 333

Who is providing the training for the Colleges?

- 10.73 While trainees pay annual fees to their college for specialist training⁵⁵, the training is provided by specialist members of the college (consultants), who are not themselves paid (apart from the wages they are paid by NSW Health as a Staff Specialist or visiting medical officer). As discussed in Chapter 13, teaching is usually done in an apprenticeship style and consultants are not necessarily taught how to do this⁵⁶.

How good is the college education?

- 10.74 From the evidence I heard, it appears to me that, whilst some colleges provide good quality specialist training, many do not. Much depends on the registrars and specialists with whom a trainee works in any given term. By and large, fellows of the colleges train junior medical officers, including registrars, according to their own somewhat idiosyncratic personal standards. Some Colleges run training programs for trainers⁵⁷.
- 10.75 It seems to me that the core business of the Colleges is to set standards, not necessarily to operate as a training and education body. The tension here is that the Colleges' fellows are generally delivering the training, in an ad hoc and unstructured fashion. I was told by many registrars that the value of any particular term depends upon the people training them⁵⁸. Without interested and engaged consultants who are interested in teaching and who have had training in how to deliver training, the registrar's training experience is not optimal, nor can it be expected to be⁵⁹. I discuss the supervision of registrars in Chapter 13.

- 10.76 All medical colleges or faculties, except psychiatry, medical administration and public health medicine, have final examinations⁶⁰. These exceptions have an oral assessment as part of the overall final assessment. Nine colleges have a part I, basic sciences examination as a condition of entry to the training program. Four colleges have a part I, basic sciences examination as a condition of progression to advanced training.
- 10.77 According to the most recent report of the Medical Training Review Panel, 3,648 vocational trainees sat a college or faculty final or fellowship examination in 2006. Of those sitting a final examination in 2006, 73.1% successfully passed⁶¹. The figure was 70.3% in 2001. The lowest pass rates in 2006 were in the Australasian Faculty of Occupational & Environmental Medicine of the Royal Australasian College of Physicians (50% in the written exam) and the Royal Australian and New Zealand College of Psychiatrists (50.2% in the clinical exam)⁶². The overall pass rate for all additional College examinations (excluding final examinations) in 2006 was 73%. These data relate to Australian trainees sitting college or faculty examinations. Some colleges also examine overseas medical practitioners wishing to practise in Australia.
- 10.78 As the training program summary in the Medical Training Review Panel report indicates, success in the final fellowship, college or faculty examination may not be the final requirement for fellowship of the respective college. Further requirements can include continued training (if the examination is not conducted at the conclusion of the final year of training), satisfactory completion of a research project, or further workplace assessment, for example⁶³.

Effect of closure of outpatient clinics

- 10.79 The Inquiry received several submissions that the closure of many, but not all, outpatient clinics in public hospitals has reduced the scope and number of learning opportunities available to junior medical officers, particularly to registrars who no longer have the opportunity to see patients pre-operatively or post-operatively⁶⁴. I was told that the closure of outpatient clinics was a cost shifting measure as attendances at outpatient clinics are funded from the state budget. Without outpatient clinics, patients are required to see GPs or consultants in their private rooms for pre-admission consultation and for follow-up after admission, both of which are federally funded. Data shows that patients also use Emergency Departments as a substitute for outpatient clinics⁶⁵.
- 10.80 I was told that requiring trainees to attend consultant's private rooms to receive the training they would otherwise receive in outpatient clinics gives rise to complex issues, relating to physical space, medical indemnity for the trainee's work and the value of the training, given that a large component would consist merely of observing the consultant's practice. It was highlighted to me that "training is doing, not watching"⁶⁶.
- 10.81 Another aspect of the closure of outpatients clinics is the question whether public hospitals are fulfilling their patient care obligations to patients, especially after discharge. I was told that access to outpatient services prevents hospital admissions and improves the affordability and continuity of care⁶⁷. I regard the follow-up of patients after discharge from a public hospital as an important obligation of the public hospital system and have addressed the communication between hospitals and GPs and community services in Chapter 15. The major barriers to opening outpatient clinics are the cost of opening and operating them, in terms of capital costs and recurrent expenditure, and the availability of clinicians to staff them.

Doctors

10.82 Doctors receive an important part of their training informally, on the job, through supervision from their senior colleagues. Teaching and supervision are obviously interlinked and therefore there are some common problems which afflict both. I discuss these problems in this section. I discuss supervision more specifically in Chapter 13.

No protected time

10.83 The Inquiry was told that an effective education and training system in the public health system requires there to be:

- time specifically devoted to education,
- remuneration for both trainer and trainee, and
- physical space allocated for the purpose⁶⁸.

10.84 Sometimes, of course, teaching will, and must, occur in clinical space as opposed to dedicated learning facilities. Submissions to the Inquiry highlighted that the quality of a student's clinical education also depends on access to patients and clinician-teachers⁶⁹.

10.85 Although clinical teaching of prevocational doctors is expected to take place within working hours in public hospitals, there is very little truly protected time for teaching, either to teach or be taught. Nor is there any protected time for supervision, which as I have noted in Chapter 13, is an opportunity for informal teaching. This means that junior doctors find it difficult to attend teaching sessions⁷⁰, even where a proportion of working time is formally allocated to education within the hospital, due to the demands of patient care⁷¹.

10.86 Although bodies external to the hospital, such as colleges, also offer junior doctors a range of learning opportunities, I heard that the requirements to take leave and to pay for courses out of one's own pocket compromise junior doctors' ability and willingness to take up those opportunities⁷².

10.87 Another reason teaching time is not respected is that consultants and registrars are generally not allocated dedicated time for teaching, supervising and mentoring junior clinical staff⁷³. Several factors impact adversely on the availability of senior doctors to teach junior doctors, including⁷⁴:

- an increasing clinical workload which reduces the time they are available to teach. I was told that rostering is so tight that leaving the ward to come to train or teach compromises patient care⁷⁵;
- the progressive disengagement of senior medical staff from the public hospital system which means that there are fewer clinicians to teach; and
- the increasing number of medical students and interns as this imposes an additional load on senior doctors to train and teach.

10.88 It was submitted that the bed occupancy rate and staffing levels also impact on opportunities for both didactic and on-the-job teaching. It is unsurprising that there should be a relationship between staffing levels in a hospital and the value placed on education and supervision. As noted above, I was told that hospitals which show an overt commitment to medical education and training find it easier to recruit and retain junior doctors. They also find it easier to meet their service requirements. As Professor Reid stated⁷⁶:

"[A] thing which I think is particularly important is recognition of the value of supervision and training.

Problems arising from a total focus on service become circular. Hospitals which have a poor reputation for training fail to attract junior staff, registrars... registrars and consultants are not supported and so recruitment at those levels fails too; therefore, service suffers."

- 10.89 Given the frequency with which I was informed by doctors about the lack of dedicated time for teaching, it is plainly a matter of significant concern throughout the medical workforce.
- 10.90 In my view, there first needs to be recognition by NSW Health of the need for protected time for the teaching of junior medical officers. This requires recognition that protecting teaching time enhances the quality of teaching that junior doctors receive and therefore the quality of the medical workforce.
- 10.91 Protecting teaching time requires that a set proportion of working time be allocated to teaching each week. The time needs to be 'protected', meaning that patient care requirements, whether they relate to direct clinical care or clerical work, do not intrude on the time.
- 10.92 Protecting teaching time creates the need for 'backfilling' so that other doctors can cover for the time that the teacher and junior medical officer are not carrying out their usual clinical work. I recognise that this presents challenges. A system should be devised to ensure the provision of appropriate cover for doctors who are required to attend training sessions. This may require the stipulation of guidelines to ensure that there is appropriate handover between the trainee and the doctor covering his or her shift for the allocated time.

Looking after teachers

- 10.93 The overarching problem is how to engage senior clinicians in the training of junior medical officers and registrars. It needs to be recognised that clinical teaching occurs in addition to clinical practice and in a context where service demands take precedence over teaching.
- 10.94 Teaching is an important aspect of the normal duties of a Staff Specialist, as indicated in the award⁷⁷. Staff specialists' performance agreements, which they are required to enter into with their designated supervisor (and which is signed by the Chief Executive of the relevant area health service), set out the expectations in respect of postgraduate and undergraduate teaching activities. The allocation of time to perform those duties forms part of the performance agreement. As discussed above, whether or not the time is in fact quarantined is another question.
- 10.95 There is a requirement in the standard service contracts for Visiting Medical Officers to teach and supervise postgraduate medical officers as reasonably required. My observation is that this is, and has always been, a normal and expected part of their duties.
- 10.96 Some say that a mandatory requirement for the delivery of training should be provided for in all consultants' contracts, particularly in the surgical specialties which are predominantly staffed by Visiting Medical Officers⁷⁸.
- 10.97 I was told by many senior clinicians that not all senior doctors are suited or interested in teaching. The Director-General of NSW Health remarked to me that, over her working career in public hospitals, this has been a real change⁷⁹. To my mind, this is a reflection

of a change in culture in the public hospital setting caused by increased demands on clinicians to focus on service delivery.

- 10.98 Submissions from junior medical officers also expressed the view that training and supervision should not be forced on all registrars and consultants, regardless of their interest and aptitude for teaching⁸⁰.
- 10.99 Doctors are not paid separately for teaching. It might be said that teaching and supervision is part of the ordinary responsibilities of a senior doctor. Indeed, the Hippocratic Oath accepts an obligation for doctors to teach, namely,
- " ... by the set rules, lectures, and every other mode of instruction, I will impart a knowledge of the art to ... students bound by this contract and having sworn this Oath to the law of medicine..."⁸¹.
- 10.100 It seems that the workload of senior doctors, both in its clinical and non-clinical components, places too many burdens on many of them to be effective teachers.
- 10.101 As a matter of practicality, teaching is often the first thing to go when doctors are facing other demands on their practice. Some of these demands no doubt derive from the private practices of some senior doctors. The Inquiry received a lot of evidence, however, that senior doctors in the public hospital system spend an inordinate amount of time on administrative and clerical duties which take them away from the clinical roles for which they have specific expertise⁸². I was also told that the disengagement of senior medical staff has meant that there are fewer staff to share the clinical workload and to teach⁸³. I regard this workload (both clinical and non-clinical) as a significant factor contributing to the lack of time, and possibly, interest, that senior doctors have to teach. This is no doubt both a cause and a consequence of the shortage of available specialists in many areas.
- 10.102 Numerous submissions to the Inquiry expressed the view that paying supervisors and teachers separately from their ordinary salary or rates to teach undergraduates and prevocational doctors would overcome these barriers⁸⁴. Other submissions noted that it is not simply a matter of money⁸⁵. Rather there is a need to value the trainer's role and recognise the time required on top of a clinical workload. In my view, what is required is recognition of the importance of the role of clinical teacher in the provision of facilities for and the dedication of time for teaching⁸⁶. This means giving them adequate resources and support so that they have time to teach, including administrative support.
- 10.103 A number of solutions were put forward during the course of the Inquiry. One submission suggested that hospitals should create specific roles in which the consultant or registrar's clinical load is reduced and they are remunerated for spending part of their working time teaching and supervising⁸⁷. For example, a position consisting of 0.2 FTE teaching and 0.8 FTE clinical work would allow one full shift in each typical week to be dedicated to teaching and supervision. Another suggestion was that an appropriate balance is 25% teaching and 75% clinical time⁸⁸.
- 10.104 I heard that financial incentives attract senior doctors to mentoring and teaching positions. For example, the training networks of the Institute of Medical Education and Training (IMET) rely on site directors of training to oversee the delivery of training in training sites, most of which are hospitals. Site directors of training are used not only in the context of prevocational training but also in the delivery of basic physician training and psychiatry training through training networks overseen by IMET⁸⁹. The number of trainees allocated to a site director of training varies as between hospitals and training networks. For example, the Inquiry was informed that a site director of prevocational training at a large hospital such as Westmead Hospital might be responsible for 140

junior medical officers in postgraduate years 1 and 2 (that is interns and residents, otherwise known as PGY1 and PGY2) , whereas a site director at Hornsby Hospital may oversee 25 or 30 such doctors⁹⁰ .

- 10.105 Generally, site directors of training are not paid for their supervisory and teaching responsibilities, although they are full time clinicians. I was told that in the past NSW Health has agreed to remunerate site directors of basic physician training for their role, based on the number of trainees allocated to them⁹¹ . I was informed that the allowance paid to this group of physician trainers generated enthusiasm for the role. I was told that it was also possible to deliver training in a more organised fashion and to increase the number of available training positions where there were paid site directors.
- 10.106 Hospitals also have supervisors of training to oversee registrars' training in the different specialties. These roles are generally required as part of the Colleges' accreditation criteria and are carried out by a fellow of the relevant college in addition to a full clinical load. The Inquiry received submissions that support for these roles is currently inadequate and increased resources are needed to fulfil the responsibilities associated with the role⁹² . Surveys conducted by IMET in recent years have shown that there is variability between hospitals in the support made available to those fulfilling these roles, in terms of time, administrative assistance, private space to meet with trainees, office equipment, technological support and mentorship⁹³ .
- 10.107 IMET would like to see a uniform approach to recognising and remunerating site directors of training, and all teaching and mentoring roles, across the NSW public hospital system⁹⁴ . It considers that the altruism that is driving the current system is waning because of the burdensome workload on the senior doctors who currently fill these roles. It says that the funds involved are relatively small and would be unlikely to cover the trainer's time to attend to all the tasks associated with the role. IMET highlighted however that it is not simply a question of money. A range of initiatives are required, including protecting the time for hospital directors of training and recognising a clinician's contribution to teaching as part of their career progression. It says that the performance appraisals of senior medical staff should also explicitly focus on teaching and supervision.
- 10.108 The Medical Deans of Australia and New Zealand also recommend that a new structure for teaching and supervision be introduced consisting of an accreditation process for clinical supervisors and teachers which recognises a set of competencies and establishes a system of appropriate financial recognition.⁹⁵
- 10.109 I agree that there needs to be a change in approach to the roles of teacher and supervisor in the hospital system. There needs to be a uniform approach to these roles that involves recognition of the people undertaking teaching and supervisory responsibilities. I have in mind that such a uniform approach would apply not only to formal teaching and training but also to supervision, that is, active attendance to review and examine the junior doctor's work.
- 10.110 It seems to me that there is also an untapped resource of retiring (or recently retired) doctors who would be well suited to taking up teaching and mentoring roles in NSW public hospitals. It was submitted to the Inquiry that there is a real place for developing a career stream for senior clinicians who wish to finish or scale down their clinical practice to allow them to remain in education and training⁹⁶ . It would make good sense to engage experienced medical staff as teachers and supervisors when they are approaching the ends of their careers, particularly in view of the shortage of specialists in many areas.

- 10.111 Some say that there should be a clear vocational ladder for senior medical staff who are willing and able to mentor, teach and supervise junior clinical staff. As one witness said⁹⁷:

"There is really substantial wastage of the experience of senior people who are very keenly involved and could provide a great deal of support to the public health system".

- 10.112 On the other hand, I heard evidence that there is a need to engage younger doctors in teaching⁹⁸:

Supervision of trainees still relies on goodwill and largely the honorary approach. NSW Health through IMET is trying to provide incentives to those prepared to provide training. Unfortunately this largely depends on those such as me in their twilight years of medical practice. We need ways to recompense younger doctors who are prepared to commit time and effort for our future medical workforce.

- 10.113 I agree that greater support needs to be given to teachers and supervisors. There is also a need to examine how future specialists measure the value of teaching work. In the short term, at least, I agree with the submissions that effort should be made to engage senior doctors who are interested in clinical teaching roles.

Recommendation 32: *NSW Health should ensure that all hospital directors and supervisors of training for prevocational doctors are provided with protected time each week to carry out their duties in relation to training and formal teaching within the hospital. This time should be protected as part of the terms of employment and through the employment performance management process.*

Recommendation 33: *NSW Health should require all clinicians who are engaged in the teaching and/or supervision of postgraduate clinical staff to satisfactorily complete courses provided by the Institute of Clinical Education and Training directed to enhancing their skills as teachers, trainers and supervisors.*

Recommendation 34: *NSW Health should explore the opportunities for and develop programs which attract senior clinicians to become involved in or else increase their involvement in, the teaching and supervision of junior clinical staff, including by developing appropriate positions and career streams for such senior clinicians.*

Teaching the teacher

- 10.114 IMET provides some courses to teach clinical supervisors and teachers how to teach⁹⁹. The *Teaching on the Run* course aims to teach consultants to recognise teaching and learning styles and teaching opportunities in clinical settings. The course teaches consultants to develop objectives for each term and the various teaching methods available to them. I was told that this course is a powerful and effective course to allow consultants to teach on a ward round with greater efficiency¹⁰⁰. Some say that all supervisors of PGY1& PGY2 doctors should do this course¹⁰¹.

- 10.115 IMET informed the Inquiry that it sponsors and coordinates regular educational forums for hospital directors of training, education support officers, trainees and JMO managers and directors of medical services¹⁰². I heard that many senior clinicians do not engage in teaching because they do not consider themselves skilled enough to do it. It seems to me that courses of this kind can overcome some of these barriers to finding enough senior doctors to teach and supervise junior doctors and that this should be encouraged by adequate funding.

Nurses

- 10.116 One of the most frequent complaints during the Inquiry was the lack of continuing education and training opportunities available to nurses. I was initially surprised to hear what an important issue this was, and it bespeaks the seriousness with which nurses take their duties.

Continuing education and training

- 10.117 There is no requirement in order to maintain continuing registration and enrolment under the *Nurses & Midwives Act 1991* (NSW) for nurses to undertake continuing education or training or to have engaged in recent practice.¹⁰³ The only requirement is payment of an annual fee.¹⁰⁴
- 10.118 However, the *Code of Professional Conduct for Nurses in Australia* (“the Code”), published by the Australian Nursing & Midwifery Council, has been endorsed by the Nurses and Midwives Board of NSW as setting out guidelines that should be observed by nurses in their professional practice.¹⁰⁵ The Code provides that a nurse must practise in a safe and competent manner in accordance with the agreed standards of the profession.¹⁰⁶ The Code also imposes a responsibility on nurses to ensure that the standard of his or her practice conforms with professional standards, with the object of enhancing the safety of the individual, any significant other person and colleagues.¹⁰⁷ Accordingly, the Code requires that nurses maintain their knowledge and skills.¹⁰⁸
- 10.119 On completion of their nursing studies, nurses in NSW receive continuing education and training through a variety of means:

In-Services

- 10.120 “In-services” are planned education programs provided for nurses by an employer in order to maintain and/or update skills and knowledge relevant to a work or employment context.¹⁰⁹ In-services are short in nature and often conducted at the unit level, but may also occur on a divisional or hospital-wide basis.¹¹⁰ I have been told that all areas of clinical nurse practice can be covered by in-services so as to update nursing staff on current best practice.¹¹¹ In-services are also useful where changes have been made to policy, procedures and documentation within a facility.¹¹² I understand that mandatory in-services are provided annually on cardio-pulmonary resuscitation, infection control, medication and drug calculations, manual handling, child protection, fire and safety, and occupational health & safety.¹¹³ Some clinical areas also have in-services relevant to their specific needs: for instance, clinical care areas may have in-services on advanced life support.¹¹⁴
- 10.121 I have been told that in-services are primarily given by Clinical Nurse Educators, Clinical Nurse Consultants and Clinical Nurse Specialists, as those occupying these roles have the experience needed to educate other nurses.¹¹⁵ NSW Health informed me that in-

services are also delivered by managers, other clinical staff (including medical and allied health) and external contractors.¹¹⁶ I understand that in-services are primarily delivered by face-to-face lectures, although some video-conferencing occurs in rural areas where IT facilities are available.¹¹⁷

- 10.122 There appear to be particular problems faced by rural hospitals in relation to accessing in-services. For instance, a nurse at Bourke Hospital told me that it is very expensive to arrange education and back-filling of positions.¹¹⁸ She said that they had tried to make arrangements for education to be delivered to nurses at the hospital.¹¹⁹ However, courses have been cancelled in the past because it is perceived that there are not enough candidates who could attend from the surrounding areas such as Brewarrina, Walgett, Lightning Ridge and Cobar.¹²⁰
- 10.123 A witness at Albury Hospital highlighted the need for education to be delivered to rural nurses because of the lack of medical officers.¹²¹ The witness told me that nurses in rural hospitals are being trained through the successful “First Line Emergency Care” course to provide effective intervention in emergency presentations.¹²² The course is reportedly giving nurses a feeling of comfort and competence, and is having a positive effect on staff retention.¹²³
- 10.124 I was informed that in many wards, arrangements are sometimes made for nursing shifts to overlap for a period of time, during which in-services (or some other form of education session) are held.¹²⁴ However, some hospitals have shifts starting at many different times, so there is no “quarantined” time for education sessions.¹²⁵
- 10.125 The importance of delivering quality education to NSW Health’s nursing workforce was expressed by one witness in the following terms:

“In terms of the professional workforce, if we are looking at patient safety and high standards of care we need to have an educated workforce, and not just a workforce that is university educated, but one that is able to maintain ongoing educational standards.”¹²⁶

Supervision by Clinical Nurse Educators and Clinical Nurse Consultants, and External Courses

- 10.126 As noted elsewhere in this chapter, a Clinical Nurse Consultant is a specialist in his or her field¹²⁷ who also works with doctors to improve clinical pathways.¹²⁸ Clinical Nurse Consultants are different from Clinical Nurse Educators in that the consultant provides consultancy as well as education.¹²⁹ Clinical Nurse Consultants may also provide higher level education – for instance, lectures and tutorials dealing with more complex cases, whereas Clinical Nurse Educators will ensure that safe care is delivered and that new nurses’ training is on schedule.¹³⁰
- 10.127 My impression was that there is a lack of education opportunities to meet the demand of nurses. NSW Health frankly acknowledged to me that it does not seem to be making much headway in meeting the education needs of nurses.¹³¹ The evidence of the following nurse, commenting on the restriction of the number of nurses per ward who are permitted to attend an “education day”, was typical:

“[I]f you don’t put your name down quickly enough then you miss out and more than regularly you do miss out because people put their names down months in advance and you don’t realise that they have and you just keep missing out”.¹³²

- 10.128 A nursing unit manager at Royal North Shore Hospital told me that although most wards at that hospital have in-service time of about 30 minutes per day, Monday to Friday, it

would be beneficial for nursing staff to have a full shift “supernumerary” to their other work to enable them to be trained in the competencies that are required to help them perform their job.¹³³

- 10.129 As noted elsewhere in this chapter, a nurse at Mudgee Hospital told me that she had not had clinical supervision, which is one way in which training and education is delivered for 4 years.¹³⁴ She said that she and her colleagues had tried to access people within the Greater Western Area Health Service to provide clinical supervision, but those people were not able to do so because of large workloads.¹³⁵
- 10.130 NSW Health provides a range of scholarships to enable nurses to undertake further education and training. For instance, scholarships are available to support post-graduate education for registered nurses, to support enrolled nurses to up-skill themselves by undertaking Registered Nurse education, for clinical placements in rural areas, and for placement of rural nurses in the city.¹³⁶
- 10.131 Some nurses, however, undertake training in their own time and at their own cost. This was confirmed by a clinical nurse consultant at Coffs Harbour Hospital who told me that there are very limited opportunities for professional development: most of it is done at nurses’ own cost and in their own time, and it may be difficult to get staff to relieve nurses to enable them to attend courses.¹³⁷ A registered nurse at Armidale Hospital informed me that if there are too many applicants for scholarships or study leave, nurses may be required to fund the education themselves.¹³⁸ Another witness told me that because Mudgee Hospital is \$750,000 over budget, expenditure on education has been cut and staff are expected to fund a lot of their own basic education.¹³⁹ A clinical nurse consultant at Coffs Harbour told me that problems are presented by the need to back-fill positions to enable nurses to attend courses.¹⁴⁰
- 10.132 NSW Health has provided \$1.4 million funding to Area Health Services to back-fill nursing positions while nurses attend training.¹⁴¹ Notwithstanding this financial assistance, many nurses reported that it was difficult to get education leave, and this leave was often cancelled at short notice if there were too many agency or casual staff on the ward replacing them.¹⁴² A real question arises as to whether this allocation is sufficient.
- 10.133 Accessing education and training appears to be particularly difficult for nurses working in rural and remote areas. A registered nurse at Armidale Hospital told me that the more “rural” a hospital gets, the poorer the level of education that is provided to staff.¹⁴³ There is less access to education because staff in rural hospitals do not have the ability to be relieved from a shift to attend courses.¹⁴⁴ She said that sometimes nurses are booked to attend education sessions only to be told on the day that they cannot go, as there are not enough staff to take their place on the ward.¹⁴⁵
- 10.134 An enrolled nurse at Port Macquarie Hospital told me that there is poor training available for mental health nurses, who cannot be released from the ward to attend training because of the press of work.¹⁴⁶ Similarly, a nurse at Wagga Wagga Base Hospital said that it is very difficult for nurses to attend education or courses, because they cannot be easily replaced on the ward when they leave.¹⁴⁷ In this context, she stated:
- “It is also part of our role to continually keep updated with improving our knowledge base and skill level anyway and it is becoming very difficult to achieve that.”¹⁴⁸
- 10.135 Complaints of a lack of nurse educators were frequent and state-wide. Commonly, larger hospitals were better off, although difficulties accessing education were still reported. For instance, a midwife at Royal Prince Alfred Hospital told me that there was

a lack of education for new staff or staff returning to midwifery, and they feel unsupported and therefore resign.¹⁴⁹ I was told by this witness that her ward has one Clinical Nurse Consultant for a 60 bed post-natal floor, a 15 bed ante-natal high dependency unit and a maternity outpatients unit.¹⁵⁰

10.136 So too, a nurse at Bankstown Hospital told me that most of the wards there do not have a dedicated educator for the nursing staff.¹⁵¹ This witness stated:

"Given that there is a lot of overseas staff coming to work with us now, there is a lot of new graduates coming through universities, a lot of new trainee enrolled nurses coming through the system as well as agency and casual nurses, and we feel it is imperative that they have proper supervision clinically and to have opportunities on the ward for training. This has been sadly neglected, I think, over the last few years. It is all been cost cutting and education has been seen as one of the last things to do over spending money somewhere else."¹⁵²

10.137 Another nurse at Bankstown Hospital told me that there has been no educator for 150 staff in the operating suite for over 12 months.¹⁵³

10.138 The Principal Nurse Educator for the Southern Hospital Network in the South Eastern Sydney/Illawarra Area Health Service confirmed that there was a lack of education and professional development opportunities for nursing staff.¹⁵⁴ She said that the majority of nurse educators in that area were based at Wollongong Hospital, and it was of particular concern that new graduates did not have clinical nurse educators to back them up in the ward areas.¹⁵⁵ She told me that new graduates start in February of each year, and to some extent require more support in their first few months, however the undergraduates (who are supernumerary) enter the system consistently over a 2-3 month period a couple of times a year.¹⁵⁶ She stated that there is a limited capacity to give the undergraduates on-the-job training because of the limited availability of educational support.¹⁵⁷

10.139 A witness at Westmead Hospital informed me that the Imaging Department, as a whole, does not have access to a clinical nurse educator.¹⁵⁸ The witness observed that nursing in that department involves a range of skills and knowledge including emergency, operating suite work, recovery, intensive care and general surgical/medical.¹⁵⁹

10.140 A nurse unit manager at Wollongong Hospital confirmed that management of student enrolled nurses and new graduate nurses is difficult due to the lack of clinical nurse educators in the Southern Hospital Network sector.¹⁶⁰ She thought that the presence of a nurse educator would provide support to junior staff and allow nurses to manage their case mix better.¹⁶¹

10.141 An enrolled nurse at Port Macquarie Base Hospital told me that there are no mental health clinical nurse educators, and advertisements have not even been placed to obtain any.¹⁶² The Nurse Unit Manager of the Emergency Department at Port Macquarie Base Hospital told me that in his experience of emergency nursing, there are inequalities between staffing ratios at rural hospitals as compared to major metropolitan hospitals, including the provision of clinical nurse educators and consultants.¹⁶³ He believed that as a result, patient care in rural areas is at a disadvantage.¹⁶⁴ A clinical nurse consultant at John Hunter Hospital raised similar concerns in relation to lack of nurse educators: at the hospital there are only one nurse educator and one clinical nurse educator for 128 beds, and units at the hospital are struggling to support the expected requirement of ongoing in-service and education.¹⁶⁵

- 10.142 A witness at Mudgee Hospital told me that all the senior positions in mental health are in Dubbo, Bathurst or Orange, rather than being spread out.¹⁶⁶ The witness said that if a person would like to be a clinical nurse consultant and has the qualifications, there are no positions that are offered outside those main areas.¹⁶⁷ In the witness' view, these positions could be "spread out" across the whole of the area through the use of e-mail, tele-health and video conferencing.¹⁶⁸
- 10.143 Some wards that had clinical educators lost them to patient care due to a lack of nurses on shifts. The Acting Divisional Manager for Women's, Children's and Family Health at Gosford Hospital told me that in the birthing suite a half-time equivalent clinical midwife educator had been employed but, because of the shortages of midwives, she was required to work shifts to provide safe care for women giving birth, rather than fulfilling the role of clinical midwifery education and support within her division.¹⁶⁹ Further, a nurse at Wagga Wagga Base Hospital told me that clinical support nurses are being asked to "come out of their role" and take a patient load, removing them from the education of staff at the bedside.¹⁷⁰ She made the following observations in this context:
- "We feel now more than ever that we need these educators to be out there and about teaching all these junior people. It is just putting so much pressure on the few senior staff that are rostered on the shifts, because they are trying to guide, support and instruct junior staff as well as look after their own patient load as well. I think that is why we have seen such a large exit of senior experienced nurses from our system."¹⁷¹
- 10.144 A nurse educator at the intensive care ward at St George Hospital told me that in order to facilitate the admission of trauma patients in that unit, the educators sometimes have to take a patient load.¹⁷² She said that as a result, the ICU educator is unable to discharge his or her responsibility to deliver in-service education to staff.¹⁷³ In this context, she stated that a lot of the advanced practice packages to enable self-learning by staff are now 15 years old: there is no external body that is providing those packages to staff, and the educators have not have time to develop them.¹⁷⁴
- 10.145 Witnesses told me that lack of education for new nurses or those returning to nursing made nurses feel unsupported, and led to resignations.¹⁷⁵
- 10.146 To my observation, there was an acute lack of clinical nurse educators outside the Sydney metropolitan area, even where such positions had been approved and attempts made to recruit. Nurses raised this with me as an important issue in keeping skills current and picking up any deficiencies in the way they did things.
- 10.147 For instance, during my visit to the Braidwood Multipurpose Service, I was told that that facility has no clinical educator.¹⁷⁶ The staff told me that this was a problem, as an educator would permit skill levels to be improved and pick up any current deficiencies.¹⁷⁷ Similarly, during my visit to Ballina Hospital, nurses told me that they have no clinical nurse educator although the hospital has approval for a 24 hours per week position.¹⁷⁸ A registered nurse at Armidale Hospital told me that they did not have a dedicated clinical nurse educator based there: there is only one 0.5 full-time equivalent educator, who is based at Tamworth.¹⁷⁹ A nurse unit manager at The Tweed Hospital said that they did not have enough clinical nurse educators to support the education of the skill mix of nurses at that facility.¹⁸⁰ Similarly, a registered nurse at Coffs Harbour Base Hospital observed that clinical nurse consultants are the major education resource for the wards, and particularly for junior staff.¹⁸¹ She expressed concern that the consultant staffing at that hospital is "woefully inadequate".¹⁸² She

noted that many of that clinical nursing consultants are based at Lismore and although they are supposed to manage the whole area, it is just “too huge”.¹⁸³

10.148 The nurse unit manager of the acute care ward at Mudgee Hospital told me that there was no dedicated clinical nurse educator at that hospital and that the role is taken on by the nurse unit manager.¹⁸⁴

10.149 The lack of nurse educators in rural hospitals is of particular concern as rural nurses tend to have a greater level of responsibility, covering a greater range of patients and roles, than their city counterparts. Rural nurses also have fewer resident medical officers and registrars to confer with on the wards, and a lot more therefore falls to nurses.¹⁸⁵ As noted above, one registered nurse at Armidale Hospital observed that the more rural a hospital gets, the poorer the level of education provided to staff.¹⁸⁶

This witness highlighted the untenable nature of this situation by stating:

“[Y]ou need to provide the appropriate education to go along with the increased level of responsibility so nurses get the skills needed to cope with this.”¹⁸⁷

Solutions

10.150 To overcome problems in recruiting nurse educators, particularly in rural areas, more use should be made of technology to provide consistently high-quality continuing education for nurses across the State. In particular, extensive use should be made of:

- (a) video-conferencing,
- (b) ‘in services’ provided by DVDs with high-quality teaching content; and
- (c) training delivered via the internet, for nurses to do either while at work or at home.¹⁸⁸

10.151 Some use is being made of technology to assist in this field. I have been told that the Sydney South West Area Health Service has its own Centre for Education and Development, which designs e-learning modules, online materials and videos, and DVDs.¹⁸⁹ Similarly, Hunter New England Area Health Service has developed a variety of e-learning programs.¹⁹⁰

10.152 I understand that other organisations have also developed high quality training programs for nurses by way of the internet and/or use of DVDs. For instance, the Australian Nursing Federation’s continuing professional education and the Royal College of Nursing Australia’s Lifelong Learning program are available online, while the University of Newcastle provides specialist mental health and drug & alcohol courses for nurses over the internet.¹⁹¹

10.153 An advantage of training delivered in this way is that it enables nurses to access quality education, regardless of the shifts on which they are working,. I have been told that nurse educators are generally only available during day shifts. Indeed, a clinical nurse educator at Liverpool Hospital informed me that the biggest problem for new nurses is after-hours shifts, when an educator is not present and there is no administrative support.¹⁹² Similarly, the Acting Director of Nursing & Midwifery at Royal North Shore Hospital said that on afternoon shifts, there are usually no nurse educators.¹⁹³ For funding reasons, they usually work on weekday morning shifts.¹⁹⁴

10.154 The use of e-learning resources will also help address the particular needs of those nurses who work on night shift. In particular, permanent night duty staff who do not see the team doctors as often, do not have the opportunity to meet with management and nursing leaders and do not see what treatment is happening on the wards, have a real

need to see what new in-service training opportunities are available and to access them.¹⁹⁵ E-learning resources may also address what seems to be a reluctance on the part of night shift nurses to attend training:

"...I also have a strong feeling that they are not interested in that kind of stuff...they are really just there to take home a pay cheque."¹⁹⁶

She told me that in her view, this was the "culture" of night shift workers.¹⁹⁷ If this is so, then the approach which I have suggested may go some way to addressing this inadequacy in that culture.

- 10.155 Training and education delivered as I have suggested is not a complete substitute for having a nurse educator on a ward to observe a nurse doing their job, and give one-on-one advice as to how to do it better. To some extent, the deficiency of nurse educators may be cured by releasing nursing unit managers back to the wards, and providing a career path to encourage senior nurses to continue to work on the wards. However, in hospitals where it has proved difficult to recruit a nurse educator, further incentives may need to be added to the position to enhance the prospects of employing one. I note that one nurse said that additional remuneration to attract clinical nurse educators to rural areas would present industrial problems, but I cannot understand why it should.¹⁹⁸

Lack of career path for nurse educators

- 10.156 Throughout the Inquiry, I received submissions and heard evidence about the difficulties encountered in recruiting and retaining nurse educators. A witness at Bankstown Hospital told me that it is very difficult to recruit nurses to clinical nurse educator positions, because nurses have to drop their penalty rates to a flat rate of pay.¹⁹⁹ A clinical nurse educator at Coffs Harbour Base Hospital told me that there was little incentive to achieve or retain the educator status because they are not released from their workload to prepare for the educational role, and this is done in their own time.²⁰⁰ One witness expressed concern that under the current Award, clinical nurse educators cannot claim the continuing education allowance, and there are thus no incentives for nurses to take on a specialist educational role.²⁰¹ However, I understand that clinical nurse educators are now eligible for payment of some education expenses.
- 10.157 Several witnesses, who were nurse educators themselves, complained of the lack of educational opportunities for educators. A nurse at Liverpool Hospital made the following comments in relation to the inequitable allocation of funding for the education of senior nurses as compared to doctors in the public health system:

"I don't believe that we have a good central leadership in terms of directing our education needs and what the standards should be for our staff. In terms of funding for education for nurses as well, this is probably more an industrial relations matter, but if we look at a comparison of staff specialists who are employed in the hospital system, under their awards they are entitled to, I think it is a \$25,000 continuing education conference leave annually, so they can go to conferences, attend meetings and education sessions, and travel internationally to do that.

We have senior nurses working in a hospital system, clinical nurse consultants, who are seen as the senior clinical resource people for our staff on the floor, and those people have no access to a regular amount of money for continuing professional development and education. They are continually struggling to acquire funds to attend conferences and meetings, and also release from

their acute care environment to attend those. So I don't think it is a bad thing. I think it is good that our doctors have the opportunity ... (but) I think there is inequity there in that our senior nurses don't have that opportunity."²⁰²

- 10.158 I understand that clinical nurse educators are generally rostered to work Monday to Friday during the day.²⁰³ This means that nurses who work on permanent evening and night shifts do not have access to the support and guidance provided by clinical nurse educators. This is inequitable and needs to be addressed. I see no sensible reason why clinical nurse educators should not be rostered to work beyond normal "daytime" hours if nurses' education needs dictate that this should occur.
- 10.159 Another problem for clinical nurse educators is that their numbers appear to be stretched too thinly over too large a geographic area. One registered nurse at Coffs Harbour explained the effect that this has on clinical nurse consultants:

"What happens is that people get jaded and faded by that and the juniors have no support and the seniors leave. You've got no career path to keep that knowledge in the system."²⁰⁴

Page 347

- 10.160 As noted above, witnesses also commonly complained that it was difficult for nurses' positions to be back-filled to enable them to attend conferences and educational courses.²⁰⁵ One clinical nurse consultant commented on the fact that clinical nurse consultants and nurse practitioners provide extensive education to nursing staff, however they do not receive support for the funding of their own continuing education and practice development.²⁰⁶ He observed that clinical nurse consultants and nurse practitioners often have to compete for scholarships to attend education programs.²⁰⁷ The bureaucratic process for scholarship applications can sometimes mean that approval for funding takes months.²⁰⁸ He told me that as a result, clinical nurse consultants and nurse practitioners often pay for conferences and seminars themselves, with no clear assurance that they will be reimbursed.²⁰⁹ A NUM at Mudgee Hospital likewise expressed the view that CNSs are not given the opportunity to further their own education and thereby improve the knowledge base of students and staff within their unit.²¹⁰
- 10.161 As adverted to above, I have been informed that as part of the review of the clinical nurse educator classification, role and remuneration, the clinical nurse educator pay scale has been restructured to a 2 year scale and clinical nurse educators are now eligible to receive payment for any post-graduate qualification higher than a post-graduate certificate, the Award requirement for appointment to a clinical nurse educator position.²¹¹ Whilst this is a step in the right direction, it seems to me to go only some way to addressing clinical nurse educators' genuinely-held concerns about their remuneration and access to educational opportunities.

Allied health

- 10.162 Allied health was described to me as the 'poor cousins' in respect of training.²¹²
- 10.163 Several submissions claimed that there are very few allied health professional educators or consultancy positions within hospitals.²¹³ I also heard that allied health staff are not supported in their ongoing education and are forced to pay for their own training.²¹⁴

- 10.164 Unlike doctors, who generally have a training allowance built into their award, so far as my researches showed, there are no allowances for training in any of the awards that govern allied health professionals.²¹⁵ Nurses have had the benefit of the creation of dedicated positions of clinical nurse educators and clinical nurse consultants. These have provided sources of in-house knowledge and expertise that is relied upon by nurses as part of their continuing education. There are no equivalent positions for allied health workers.
- 10.165 I was interested to learn that with the exception of psychologists²¹⁶ and pharmacists, for allied health professionals, there is no longer a requirement for a period of internship or practical training prior to obtaining full accreditation to practice. I note that whilst various courses in health sciences and allied health related areas do have components of practical experience, there is little consistency between the various areas of practice.
- 10.166 I was told that prior to 1986, physiotherapists were required to spend 12 months in a public hospital prior to obtaining full registration by the NSW Physiotherapists Registration Board. I was interested to learn that a voluntary internship program for physiotherapists continues to run and involves approximately 150 interns per year. I heard that Prince of Wales Hospital takes 15 interns each year, one being seconded to the Sydney Children's Hospital, one to Manning Hospital, one to Cootamundra Hospital and one to the Mercy Care Centre, Young. Each participant pays only \$50 to participate in the programme.²¹⁷

"Such programs provide an ideal beginning for a new practitioner, and would be a good model to use in other allied health professions."²¹⁸

- 10.167 This sounds like an excellent program which, I would imagine, would benefit the new professionals, regional and rural centres who receive the 'interns', and the patients who receive the benefit of the constructive continuing education of the physiotherapists.

Recommendation 35: *NSW Health should consider the enhancement of the training and education provided for allied health professionals, by, at least:*

- (a) *Considering the provision of funding directly, or else indirectly through payment of allowances for attendance at, and participation in external education and training courses relevant to the particular allied health specialty; and*
- (b) *Considering whether it would be appropriate and cost effective to create specific positions for the provision of education to the particular allied health specialties.*

Use of technology

Simulation technology

- 10.168 During the course of the Inquiry, I had occasion to visit 2 simulation centres, which provide health professionals with hands-on training, including within an inter-disciplinary team based simulated medical situation. I visited the Sydney Medical Simulation Centre and Blacktown Hospital's Simulation Unit.
- 10.169 I was told that simulation is a very valuable learning method and one of the best ways to train participants in the essential elements of teamwork²¹⁹. I was told that the future is in simulation and that due to reduced opportunities for training during direct patient care,

simulation is a necessary component of any training program as a complement to the clinical experience.

- 10.170 There are different forms of simulation and it is used for different purposes. A number of technologies are used in medical simulation, including haptics (which are computer-based), robot technology, actors and role play²²⁰. For instance, I heard that because key-hole surgery had a high complication rate when it was first introduced, it drove the development of haptics in that field of surgery²²¹.
- 10.171 I was told that training in synthetic environments not only improves clinical skills but also improves communication skills, not only with patients but also among health professionals. For example, simulation may consist of recreating a stressful environment in the emergency department and teaching trainees where to stand, how to direct others and how loud to speak²²². Or it may allow doctors to case plan for a complex case and practice the procedure in advance. These are things that are not taught consistently in the workplace²²³.
- 10.172 I was told that simulation centres are not used as much as they should be in the NSW health sector in terms of the number of health professionals with access to this type of learning²²⁴. Clinicians say that they should be used more as complementary to clinical teaching and instruction that occurs 'on-the-job'²²⁵. I heard that one of the groups which has a particular need for these training opportunities are emergency response teams.
- 10.173 NSW Health has not elucidated a state-wide strategy for simulation centres, nor has it committed recurrent funding to them. I was told that, as a result, it is difficult for area health services, including both managers and clinicians, to have much influence on how training is delivered in this area. The Sydney Medical Simulation Centre is self-funded in that it relies on one-off educational grants and the fees charged to trainees to operate²²⁶.
- 10.174 Ideally, each area health service should have access to a simulation centre and each hospital should have access to some level of simulation equipment, but I accept that the facilities are expensive²²⁷. In my view, NSW Health should monitor developments in simulation technology so that, when appropriate, simulation centres can be provided which will be able to be used by a larger number of staff than at present.

Video conferencing and online training

- 10.175 I heard that delivering training by video conferencing and on-line methods is particularly useful for rural and remote hospitals²²⁸. In my view, these methods of training should be increased where appropriate to ensure an equitable delivery of training to all staff across the State. I make recommendations about this below.

Inter-disciplinary training

- 10.176 As I discussed earlier in this chapter, the early prevocational years represent an important phase in the training of doctors. They are also important in the training of nurses and allied health professionals. There are many clinical skills which are used by doctors, nurses and allied health professionals alike. At the present time, the training sectors for these groups are fragmented and there is limited collaboration and coordination between them. In my view, there is room for inter-disciplinary training of common skills in the early years of practice.

- 10.177 It seems to me that the current systems for undergraduate and postgraduate education could do a lot more to teach health professionals how to work as a team in a multi-disciplinary environment. Numerous clinicians who made submissions to the Inquiry expressed the view that inter-professional training is valuable²²⁹ and that it is presently under-utilised as a training method. They said that it can encourage team-building between doctors, nurses and allied health²³⁰ and reflect what is needed for patient care on the ward. As one witness stated²³¹:

"Part of the archaic models that we deal with is that we are dealing with a medical and, I must say, a nursing structure which was probably best developed in the early 20th century, had reached its peak in the late 20th century, and now in the 21st century we are dealing with these craft groups who are very role-defined, whether it be by a College of Surgeons or whether it be by some other college, when in fact a lot of hospital care requires something quite different, particularly on the wards with acutely ill patients..."

- 10.178 Some health professionals, particularly doctors and nurses, are required to have many common skills in their junior years including, communication skills, taking or reading the various observations of the patient's condition, taking blood, inserting cannulas and clinical note recording²³². For instance, at the present time, I was told that an intern, resident and registered nurse are required to have the same set of practical skills to care for a patient, yet they are taught those skills in 3 or 4 different places by 3 or 4 different disciplines and by different methods²³³. I was told that ambulance officers are also required to learn many skills which are common with nurses²³⁴.
- 10.179 The Inquiry was told that inter-disciplinary training for technical skills such as taking a history or blood would be sensible²³⁵. It also has symbolic value, as stated this way²³⁶:
- "If people realise that they are sharing a particular skill or competency, it might begin to dissolve some of those tight professional boundaries that are very inhibitory."
- 10.180 The Royal Australasian College of Physicians agreed that there is room for inter disciplinary teaching at the prevocational level but says that it is not possible at vocational level²³⁷. I accept that at vocational level doctors are required to learn skills and professional practices that go far beyond what can be taught by uniform training for many disciplines. But, nevertheless, there is room for colleges and NSW Health to explore what synergies and efficiencies can be made in vocational training which presently engages trainees over a very lengthy period.
- 10.181 In my view, there is a need for a new institutional form of clinical education in public hospitals which would be multi-disciplinary, involving prevocational doctors, nurses and allied health staff. The Inquiry received evidence that the health professions currently live in "silos" and that an interdisciplinary approach to learning may engender learnt teamwork.
- 10.182 Training is already delivered in this way in some specific areas. The Inquiry received evidence about the RAMPAC (Recognition and Management of Patients with Acute Conditions) course run for St George Hospital and St Vincent's Hospital junior medical and nursing staff on the St Vincent's Hospital campus²³⁸. This course is a combined initiative between St Vincent's Hospital and the St George Hospital and arises from the work of the late Professor Don Harrison and Associate Professor Teresa Jacques around the clinical emergency response to the deteriorating patient. Associate Professor Jacques gave evidence about an independent evaluation of the RAMPAC program and quoted from a collation of evaluations of the course²³⁹:

"It is interesting to note both medical and nursing participants flagged enhancement of communication as a benefit gained from a course. It is clear that doctors and nurses feel that communication needs to be improved between the professions. Doctors and nurses thought participating together in the scenarios provided an opportunity to gain insight into each other's professional role. Also, the ability to communicate pertinent clinical information, exercising 'assertiveness' and 'diplomacy' was highlighted as a course benefit."

- 10.183 The Inquiry also received evidence about the NSW Institute of Trauma Education and Injury Management²⁴⁰ which develops clinical practice guidelines for the management of trauma patients in the health system. It delivers education in a multi-disciplinary way in recognition of the fact that members of trauma teams are required to have a significant number of competencies in common. I was told that particularly in rural areas, trauma teams have to be flexible enough to deliver these competencies with whatever clinical staff are available to deliver it. Multidisciplinary training facilitates this. The Inquiry received evidence that²⁴¹:

"we have serious failings in health in terms of how we educate at an undergraduate level and at a postgraduate level to work as a team in a multidisciplinary environment - how we communicate with each other, how we become good team leaders, how we become good team members. We are really only just starting to get into that realm.

When you look at all the root cause analysis that gets done for major sentinel events in the system, it is communication, it is education, it is team functioning."

- 10.184 In some jurisdictions, such as Illinois in the United States, interdisciplinary education occurs at an undergraduate level. I was told that at Colorado University, a health science school delivers both medicine and nursing undergraduate education²⁴². Discipline-specific training is delivered but the two professions also train together where appropriate. As much undergraduate training takes place in hospitals, I see that a new inter-disciplinary education and training structure for NSW Health ought also engage the Universities providing undergraduate education in discussions about inter disciplinary training during the undergraduate courses.
- 10.185 Inter-disciplinary training would remedy the deficiencies in the training received (or, more particularly) not received by allied health which I discussed above.
- 10.186 All of the evidence which I received about standards of care, and the inadequacies of education and training demonstrates that there are real deficiencies which need to be addressed with a fresh and comprehensive approach.
- 10.187 The first step is an acceptance by NSW Health that education and training is a part of the "core business" of the delivery of health care in NSW. Without this being accepted, there will be no sufficient commitment at all levels of the activities of NSW Health to ensuring that education and training has its rightful place.
- 10.188 What is then necessary is a more structured system for the education and training of young and newly graduated health professionals than is currently in place. The system I have in mind would require the establishment of a body to oversee, coordinate and deliver inter-disciplinary training to medical, nursing and allied health staff. I therefore make recommendations for the establishment of a NSW Institute of Clinical Education & Training that would deliver education and training through a faculty in each area health

service. It would coordinate and deliver inter-disciplinary team-based training to all post-graduate clinical staff. As regards doctors, this would initially be limited to prevocational training. I note that IMET presently coordinates several specialist training networks. I do not envisage that my recommendations would disrupt the operation of any of those networks, or the prevocational training networks, but rather that the Institute would absorb these activities and structures, building upon them as necessary.

- 10.189 The interdisciplinary training that I propose for postgraduates would involve multiple modes of teaching for junior clinical staff so as to ensure that it can be delivered State-wide, including:
- practical clinical skill modelling;
 - individual on-line learning;
 - theoretical tutorials which can be transmitted by video-conferencing facilities; and
 - targeted learning in simulation centres, where appropriate.
- 10.190 In my view, the most effective way to deliver inter-disciplinary training is to engage a broad range of health professionals in teaching and to introduce professionals with skills which can be learnt by clinicians. The person with the skills and competencies being taught should be the teacher. For example, there is no need for a doctor to teach interns or nurses how to take blood. That can, and in my opinion should, be taught by a pathology technician, where available. That is because a pathology technician is likely to be far more skilled in the task than others because they will undertake it much more frequently than other clinicians. Another example would be where communication skills may be best taught by a skilled communicator with techniques and experience in overcoming the “authority gradient” than being taught by a clinician based, largely, on experience which may include good or bad habits.
- 10.191 Very few doctors who spoke to the Inquiry about inter-disciplinary training resisted the notion that some competencies at junior level can be taught to doctors by non-doctors²⁴³ or that medical prevocational training could be effective when taught in common with nurses and allied health professionals. However, I accept the views that were expressed that, when it comes to applying the complex science and medicine that doctors must learn so as to diagnose and carrying out multi-factorial assessments appropriately, an experienced senior doctor should deliver the teaching²⁴⁴. But this is simply an example of the teaching being done by the most appropriate clinician.
- 10.192 It is beyond the scope of the task given to me to make recommendations about the content of an interdisciplinary training curriculum, and it would be foolhardy for me to do so. The *Australian Curriculum Framework for Junior Doctors* established in 2006 under the auspices of the Committee of the Presidents of Postgraduate Medical Education Councils (CPMEC) is a helpful, but not necessarily completely comprehensive, guide to what it may cover so far as doctors are concerned. That Curriculum outlines the general knowledge, skills and behaviour that prevocational doctors should acquire, regardless of their planned specialisation or training location²⁴⁵. The Inquiry received evidence that that curriculum includes a number of team safety issues and communication issues that could be taught to the junior staff in the other health disciplines²⁴⁶.
- 10.193 It seems clear that some of the skills and competencies that doctors, nurses and allied health professionals are all required to have, and which they should therefore be taught together, would include, but not be limited to:
- (a) Note-taking and record keeping;
 - (b) Communication with patients;

- (c) Communication with other health professionals;
 - (d) Handover;
 - (e) Medication management;
 - (f) Matters relating to the management of the health system, including why information is collected; and
 - (g) Certain clinical skills, such as taking blood, using and being familiar with common place machinery and equipment.
- 10.194 A defined curriculum does not remove the need for the learning that occurs in the workplace but it will help to ensure that a minimum satisfactory standard is achieved across the health professions. In my view, management and administration training and budgetary type training should be incorporated into the program. It would also be valuable to incorporate training on patient deterioration and the purpose and functions of the Coroner's Court.
- 10.195 Having regard to the frequent evidence received by the Inquiry about the lack of dedicated time for education and training, there is a need to mandate protected time for training and education. After consultation and much consideration, in my view, the amount of mandatory time dedicated to teaching should be a minimum of 20% for PGY1 clinical staff and 10% for PGY2 clinical staff. A significant component of protected teaching time must consist of bedside teaching. This should be coupled with a system of performance assessment of all doctors, which I outline in Chapter 7.
- 10.196 In my view, it is vital that teaching remain the central focus in the early postgraduate period for public hospitals and other training settings that may be developed in the private sector. Standardising the teaching of these basic, yet essential, skills and competencies in the early years of practice should ensure:
- (a) that all health professionals are properly taught these skills in a professional and consistent way; and
 - (b) that there be an improvement in the relationship between health professionals, given that the provision of health care is, and ought be articulated to be, patient centred team-based care.

Recommendation 36: *Within six months, NSW Health is to establish a chief executive governed statutory health corporation pursuant to s.41 of the Health Services Act 1997 to fulfil the role of a NSW Institute for Clinical Education and Training. The Institute is to have, at least, the following principal purposes and functions:*

- (a) *to design, institute, conduct and evaluate a program for the postgraduate clinical education and training for all new postgraduate professional clinical staff employed in NSW public hospitals;*
- (b) *to design, institute, conduct and evaluate leadership training for clinicians to enable clinicians to become clinical leaders and also health system leaders;*
- (c) *to design, institute, conduct and evaluate training for clinicians to enable clinicians to become skilled teachers and trainers for the trainees in all of the programs conducted by the Institute;*
- (d) *to design, implement and oversee an appropriate performance evaluation program for professional clinical staff whilst undergoing postgraduate clinical training; and*

- (e) *to design, implement, conduct and evaluate clinical education and training to enable medical practitioners to be qualified, competent and capable of practising as hospitalists in NSW public hospitals.*

The Institute is to have at least, the following secondary purposes and functions:

- (f) *to liaise with the College of Nursing so as to ensure that the postgraduate education and training programs are appropriately designed and delivered; and*
- (g) *to liaise with the Deans of tertiary education institutions which provide undergraduate education in the various Health Science disciplines at, or with the assistance of, NSW public hospitals in order to identify all synergies between the clinical education and training of undergraduates and post-graduate trainees and to seek to make more efficient the respective education and training regimes, including the delivery of the education and training; and*
- (h) *to liaise with the various medical colleges which provide vocational education and training for medical practitioners in order to ensure that:*
- (i) *the most efficient and effective means of education and training are provided for vocational trainees in the employment of NSW Health; and*
- (ii) *the most appropriate placement program for vocational trainees in the employment of NSW Health having regard to both the health service delivery requirements of NSW Health and the training requirements of the respective Medical College.*

Recommendation 37: *The Institute in the provision of its programs adopt the following guiding principles:*

- (a) *that clinical education and training should be undertaken in a multi-disciplinary environment which emphasises inter disciplinary team based patient centred care;*
- (b) *that the education and training be delivered by the most appropriate and suitable person regardless of the profession or specialty of the individual, and including, where appropriate, non-clinically trained personnel;*
- (c) *that all prevocational clinical staff enrolled in the Institute's programs be required to spend a minimum of 20% of their ordinary rostered time in Year One and a minimum of 10% of their time in Year Two participating in the training programs; and*
- (d) *that the clinical education and training program for prevocational clinical staff include at least four different components, namely:*
- (i) *Formal teaching to which currently employed and contracted senior clinical staff would contribute;*
- (ii) *E-learning by self-completed modules;*
- (iii) *Simulation training conducted by senior clinical staff at simulation centres and facilities;*

(iv) and Clinical skill modelling where postgraduate clinical staff are supernumerary for the relevant mandatory time to enable observation of, and modelling of, clinical skills being demonstrated by senior clinicians.

- 1 Dr Leonie Watterson, Royal North Shore Hospital hearing, 14 March 2008, transcript 433.18-28; Professor David Harris, Westmead hearing, 10 April 2008, transcript 1564.5-10; Professor Saul Freedman, Concord hearing, 24 April 2008, transcript 2178.40-2180.42; Professor Alexander Reid, Wagga Wagga hearing, 22 April 2008, transcript 1902.41-1903.26; Dr Roderick Bishop, Nepean Hospital hearing, 8 April 2008, transcript 1382.20-1383.18.
- 2 Professor Saul Freeman, Concord hearing 24 April 2008, transcript 2178.
- 3 Confidential Sydney Children's Hospital hearing, 19 May 2008, transcript 54.27.
- 4 Professor Michael Cox, Nepean Hospital hearing, 8 April 2008, transcript 1344.
- 5 Confidential Mudgee Hospital hearing, 20 May 2008, transcript 12.20.
- 6 Confidential Sydney Children's Hospital hearing, 19 May 2008, transcript 54.27.
- 7 Confidential Mudgee Hospital hearing, 20 May 2008, transcript 12.20.
- 8 Dr Leonie Watterson, Royal North Shore Hospital hearing, 14 March 2008, transcript 434.9.
- 9 Drs Timothy Tan, Lisa Phipps and Jeremy Hsu, Westmead hearing, 10 April 2008, transcript 1497.1-13.
- 10 Submission of Dr Michelle Bullmore, Dr Amanda Brownlow, undated, SUBM.020.0210 at 9.
- 11 Submission of Dr Michelle Bullmore, Dr Amanda Brownlow, undated, SUBM.020.0210 at 7.
- 12 Professor Sandy Reid, Wagga Base Hospital hearing, 22 April 2008, transcript 1903.
- 13 Meeting with the Royal Australasian College of Physicians, 3 July 2008.
- 14 Dr Nicholas Stephenson, Wagga Wagga hearing, 22 April 2008, transcript 2016.46.
- 15 Submission of Dr Andrew Hooper, 30 March 2008, SUBM.008.0017 at 6.
- 16 Submission of Professor John Fraser, Head of School of Rural Medicine, University of New England, undated, SUBM.005.0238 at 1.
- 17 Meeting with the Institute of Medical Education and Training, 3 April 2008, transcript 8.30.
- 18 Patient Safety and Clinical Quality Program Performance Agreement 2007/08 between NSW Health and public health organisations.
- 19 Meeting with the Greater Metropolitan Clinical Taskforce, 7 March 2008.
- 20 Professor Anthony Cunningham, Westmead hearing, 10 April 2008, transcript 1565.
- 21 Dr Judith Trotman, Concord Hearing, 24 April 2008, transcript 2193.
- 22 The system of education and training in New South Wales of medical officers after university graduation.
- 23 Meeting with the Institute of Medical Education and Training, 3 April 2008.
- 24 Meeting with the Institute of Medical Education and Training, 3 April 2008, transcript 19.20.
- 25 Meeting with the Institute of Medical Education and Training, 3 April 2008, transcript 19.
- 26 As at April 2008, Meeting with the Institute of Medical Education and Training, 3 April 2008.
- 27 Meeting with the Institute of Medical Education and Training, 3 April 2008, transcript 10, 11.
- 28 Meeting with the Institute of Medical Education and Training, 3 April 2008, transcript 55.
- 29 Meeting with the Institute of Medical Education and Training, 3 April 2008, transcript 31.28.
- 30 Letter from the Institute of Medical Education and Training to the Special Commission of Inquiry, 22 May 2008.
- 31 Meeting with the Institute of Medical Education and Training, 3 April 2008, transcript 8.
- 32 Meeting with the Institute of Medical Education and Training, 3 April 2008, transcript 58.3-5.
- 33 Meeting with the Institute of Medical Education and Training, 3 April 2008, transcript 30.

-
- 34 Confidential hearing at the Inquiry's offices via video-link, 29 May 2008, transcript 8.9-29; Dr Scott Whyte, Gosford hearing, 10 March 2008, transcript 101.42-102.17.
- 35 Submission of Dr Clare Skinner, 14 March 2008, SUBM.014.0230.
- 36 Letter from the Institute of Medical Education and Training to Special Commission of Inquiry, 22 October 2008.
- 37 Meeting with the Institute of Medical Education and Training, 3 April 2008.
- 38 Meeting with the Institute of Medical Education and Training, 3 April 2008.
- 39 Dr Rebecca Kozor, Hornsby hearing, 11 March 2008, transcript 174.32-38; Dr Benjamin East and Dr Ksenia Katyk, public hearing at the Inquiry's offices via video-link from Newcastle, 30 May 2008, transcript 3257.32-3258.7.
- 40 Dr Rebecca Kozor, Hornsby hearing, 11 March 2008, transcript 172.
- 41 Dr Benjamin East and Dr Ksenia Katyk, public hearing at the Inquiry's offices via video-link from Newcastle, 30 May 2008, transcript 3257.33-42.
- 42 Submission of Dr Andrew Hooper, 30 March 2008, SUBM.008.0017.
- 43 Dr Benjamin East, Dr Ksenia Katyk, video conference hearing, 30 May 2008, transcript 3256.
- 44 Submission of Dr Andrew Hooper, 30 March 2008, SUBM.008.0017.
- 45 Dr Roslyn Crampton, Westmead hearing, 10 April 2008, transcript 1515.41-43.
- 46 Dr Suzanne Hodgkinson, Liverpool hearing, 17 April 2008, transcript 1857.
- 47 Letter from the Institute of Medical Education and Training to the Special Commission of Inquiry, 22 October 2008.
- 48 Dr Kathryn Porges, Gosford hearing, 10 March 2008, transcript 61.30.
- 49 Letter from the Institute of Medical Education and Training to the Special Commission of Inquiry, 22 October 2008; Institute of Medical Education and Training, *Standards of Education, Training and Supervision for Prevocational Trainees and Post AMC Supervised Training*, Accreditation Report (version 4.3).
- 50 Dr Peter Finlayson, Tamworth hearing, 25 March 2008, transcript 833.
- 51 Dr Peter Finlayson, Tamworth hearing, 25 March 2008, transcript 835.6.
- 52 Letter from the Institute of Medical Education and Training to the Special Commission of Inquiry, 22 October 2008.
- 53 Submission of Wyong and Gosford Medical Staff Councils, March 2008, SUBM.002.050.
- 54 Submission of Wyong and Gosford Medical Staff Councils, March 2008, SUBM.002.050.
- 55 Drs Timothy Tan, Lisa Phipps and Jeremy Hsu, Westmead hearing, 10 April 2008, transcript 1497.27-1498.8. I was told that surgical registrars pay \$4,900 per annum to the Royal Australasian College of Surgeons in Melbourne and physicians pay \$1,600 per annum to the Royal Australasian College of Physicians.
- 56 Drs Timothy Tan, Lisa Phipps and Jeremy Hsu, Westmead hearing, 10 April 2008, transcript 1497.1-13; NSW Health Briefing, 4 April 2008, transcript 45.15-46.35.
- 57 Meeting with Royal Australasian College of Physicians, 24 June 2008.
- 58 Confidential Concord hearing, 24 April 2008, transcript 11.36-38.
- 59 Confidential Concord hearing, 24 April 2008, transcript 11.36-38.
- 60 Medical Training Review Panel, *Eleventh Report - December 2007*, 2008, Commonwealth of Australia, Canberra, 77.
- 61 Medical Training Review Panel, *Eleventh Report - December 2007*, 2008, Commonwealth of Australia, Canberra, 77.
- 62 Medical Training Review Panel, *Eleventh Report - December 2007*, 2008, Commonwealth of Australia, Canberra, Table 4.34.
- 63 Medical Training Review Panel, *Eleventh Report - December 2007*, 2008, Commonwealth of Australia, Canberra, 79.

-
- ⁶⁴ Submission of Dr Peter Rankin, 31 March 2008, SUBM.014.0014 at 2; Submission of Professor John Harris, 2 April 2008, SUBM.006.0229; Professor Michael Cox, Nepean Hospital hearing, 8 April 2008, transcript 1341.
- ⁶⁵ Booz, Allen, Hamilton, *Key Drivers of Demand in the Emergency Department*, December 2007, Sydney.
- ⁶⁶ Professor Michael Cox, Nepean Hospital hearing, 8 April 2008, transcript 1342.
- ⁶⁷ Submission of Dr Peter Rankin, 31 March 2008, SUBM.014.0014 at 15.
- ⁶⁸ Professor Sandy Reid, Wagga Base Hospital hearing, 22 April 2008, transcript 1902.
- ⁶⁹ Submission of Dr Andrew Pesce on behalf of the Westmead Medical Staff Council, undated, SUBM.013.0089 at 94.
- ⁷⁰ Drs Timothy Tan, Lisa Phipps and Jeremy Hsu, Westmead hearing, 10 April 2008, transcript 1497.1-13.
- ⁷¹ Dr Leonie Watterson, Royal North Shore Hospital hearing, 14 March 2008, transcript 434; Confidential Prince of Wales Hospital hearing, 1 May 2008, transcript 54.
- ⁷² Dr Benjamin East and Dr Ksenia Katyk, public hearing at the Inquiry's offices via video-link from Newcastle, 30 May 2008, transcript 3261.31-44; Submission of the Hunter Resident Medical Officers' Association, SUBM.004.0161 at 162-163.
- ⁷³ Submission of the Hunter Resident Medical Officer Association, SUBM.004.0161 at 164.
- ⁷⁴ Submission of the Westmead Medical Staff Council, undated, SUBM.013.0089 at 6.
- ⁷⁵ Dr Leonie Watterson, Royal North Shore Hospital hearing, 14 March 2008, transcript 439.
- ⁷⁶ Professor Sandy Reid, Wagga Wagga hearing, 22 April 2008, transcript 1903.10.
- ⁷⁷ Staff Specialists (State) Award.
- ⁷⁸ Experts' Conference, 16 September 2008, transcript 282.3-10.
- ⁷⁹ NSW Health briefing, 4 April 2008, transcript 45.43.
- ⁸⁰ Submission of the Hunter Resident Medical Officer Association, SUBM.004.0161 at 4.
- ⁸¹ National Library of Medicine website: http://www.nlm.nih.gov/hmd/greek/greek_oath.html.
- ⁸² Confidential Prince of Wales Hospital hearing, 1 May 2008, transcript 54.
- ⁸³ Professor David Harris, Westmead hearing, 10 April 2008, transcript 1562.
- ⁸⁴ Meeting with the Institute of Medical Education and Training, 3 April 2008; Meeting with the Australian Medical Association (NSW) & Australian Salaried Medical Officers Federation (NSW), 23 June 2008.
- ⁸⁵ Meeting with the Hospital Reform Group, 23 May 2008.
- ⁸⁶ Meeting with the Institute of Medical Education and Training, 3 April 2008.
- ⁸⁷ Submission of the Hunter Resident Medical Officer Association, SUBM.004.0161.
- ⁸⁸ Professor Saul Freedman, Concord hearing, 24 April 2008, transcript 2181.25-32.
- ⁸⁹ Meeting with the Institute of Medical Education and Training, 3 April 2008, transcript 32.
- ⁹⁰ Meeting with the Institute of Medical Education and Training, 3 April 2008, transcript 33.1.
- ⁹¹ Meeting with the Institute of Medical Education and Training, 3 April 2008, transcript 37.
- ⁹² Submission of the Australian and New Zealand College of Anaesthetists, 28 March 2008, SUBM.053.196 at 14.
- ⁹³ Institute of Medical Education and Training, *Anaesthesia Training in NSW, Recommendations for the Delivery of Anaesthesia Training in NSW Health Services – Final Report*, July 2007, p. 49; Institute of Medical Education and Training, *Review of (Adult) Cardiology Training in NSW*, Discussion Paper, February 2006 noted that trainers mentioned the lack of recognition given to training and that they are not taught educational skills.
- ⁹⁴ Meeting with the Institute of Medical Education and Training, 3 April 2008, transcript 32.
- ⁹⁵ Submission on behalf of the Deans of Medical Schools in New South Wales and the Australian Capital Territory, undated, SUBM.034.0016 at 23.

-
- ⁹⁶ Meeting with the Institute of Medical Education and Training, 3 April 2008; Professor David Harris, Westmead Hospital hearing, 10 April 2008, transcript 1564.
- ⁹⁷ Professor Michael Fearnside, Westmead Hospital hearing, 10 April 2008, transcript 1159.
- ⁹⁸ Professor Graeme Richardson, Wagga Wagga hearing, 22 April 2008, transcript 1966.
- ⁹⁹ Dr Andrew Keegan, Nepean Hospital hearing, 8 April 2008, transcript 1413.26-1414.9; Meeting with the Australian Medical Association (NSW) & Australian Salaried Medical Officers' Federation (NSW), 23 June 2008.
- ¹⁰⁰ Meeting with the Australian Medical Association (NSW) & Australian Salaried Medical Officers' Federation (NSW), 23 June 2008.
- ¹⁰¹ For example, Dr Andrew Keegan, Nepean Hospital hearing, 8 April 2008, transcript 1414.
- ¹⁰² Meeting with the Institute of Medical Education and Training, 3 April 2008.
- ¹⁰³ Letter from Nurses & Midwives Board of NSW to Special Commission of Inquiry, 12 September 2008.
- ¹⁰⁴ Letter from Nurses & Midwives Board of NSW to Special Commission of Inquiry, 12 September 2008.
- ¹⁰⁵ Australian Nursing & Midwifery Council, *Code of Professional Conduct for Nurses in Australia*, 2003, Australian Nursing & Midwifery Council, Dickson; Letter from the Nurses & Midwives Board of NSW to the Special Commission of Inquiry, 12 September 2008; see also s. 43(1) of the *Nurses & Midwives Act 1991* (NSW), which provides that the Nurses & Midwives Board may establish one or more codes of professional conduct setting out guidelines that should be observed by nurses and midwives in their professional practice, and the Nurses & Midwives Board may from time to time amend or replace a code of professional conduct.
- ¹⁰⁶ Australian Nursing & Midwifery Council, *Code of Professional Conduct for Nurses in Australia*, 2003, Australian Nursing & Midwifery Council, Dickson ACT at 2; Letter from Nurses & Midwives Board of NSW to Special Commission of Inquiry, 12 September 2008.
- ¹⁰⁷ Australian Nursing & Midwifery Council, *Code of Professional Conduct for Nurses in Australia*, 2003, Australian Nursing & Midwifery Council, Dickson ACT at 2; Letter from Nurses & Midwives Board of NSW to Special Commission of Inquiry, 12 September 2008.
- ¹⁰⁸ Letter from Nurses & Midwives Board of NSW to Special Commission of Inquiry, 12 September 2008.
- ¹⁰⁹ Submission of NSW Nurses' Association, September 2008, SUBM.095.0001 at 27.
- ¹¹⁰ Letter from NSW Health to Special Commission of Inquiry, 4 September 2008.
- ¹¹¹ Submission of NSW Nurses' Association, September 2008, SUBM.095.0001 at 28.
- ¹¹² Submission of NSW Nurses' Association, September 2008, SUBM.095.0001 at 27.
- ¹¹³ Submission of NSW Nurses' Association, September 2008, SUBM.095.0001 at 27.
- ¹¹⁴ Submission of NSW Nurses' Association, September 2008, SUBM.095.0001 at 27.
- ¹¹⁵ Submission of NSW Nurses' Association, September 2008, SUBM.095.0001 at 27.
- ¹¹⁶ Letter from NSW Health to Special Commission of Inquiry, 4 September 2008.
- ¹¹⁷ Submission of NSW Nurses' Association, September 2008, SUBM.095.0001 at 27.
- ¹¹⁸ Mary-Louise Davis, Bourke hearing, 9 May 2008, transcript 2680.6-7.
- ¹¹⁹ Mary-Louise Davis, Bourke hearing, 9 May 2008, transcript 2680.7-9.
- ¹²⁰ Mary-Louise Davis, Bourke hearing, 9 May 2008, transcript 2680.10-14.
- ¹²¹ Confidential Albury hearing, 23 April 2008, transcript 60.13-15.
- ¹²² Confidential Albury hearing, 23 April 2008, transcript 60.16-20.
- ¹²³ Confidential Albury hearing, 23 April 2008, transcript 60.20-27.
- ¹²⁴ See for example the evidence of Marilyn Hibbert, Hornsby hearing, 11 March 2008, transcript 192.28-33.
- ¹²⁵ Andrea Delprado, Liverpool hearing, 17 April 2008, transcript 1888.12-20.
- ¹²⁶ Andrea Delprado, Liverpool hearing, 17 April 2008, transcript 1888.2-6.
- ¹²⁷ Veronica Croome, Gosford hearing, 10 March 2008, transcript 87.4-7.

- ¹²⁸ Peter Campbell, Royal North Shore Hospital hearing, 2 April 2008, transcript 1193.34-36.
- ¹²⁹ Peter Campbell, Royal North Shore Hospital hearing, 2 April 2008, transcript 1194.18-26.
- ¹³⁰ Peter Campbell, Royal North Shore Hospital hearing, 2 April 2008, transcript 1194.29-35.
- ¹³¹ NSW Health briefing, 4 April 2008, transcript 84.30-34.
- ¹³² Alison Jux, Tweed Heads hearing, 29 April 2008, transcript 2401.24-27.
- ¹³³ Tracy Wittich, Royal North Shore Hospital hearing, 14 March 2008, transcript 395.11-35.
- ¹³⁴ Confidential Mudgee hearing, 20 March 2008, transcript 7.36-37.
- ¹³⁵ Confidential Mudgee hearing, 20 March 2008, transcript 8.1-3.
- ¹³⁶ NSW Health briefing, 4 April 2008, transcript 85.29-35.
- ¹³⁷ Confidential Coffs Harbour hearing, transcript 23.44-24.4.
- ¹³⁸ Confidential Armidale hearing, transcript 7.14-18.
- ¹³⁹ Confidential Mudgee hearing, 27 March 2008, transcript 12.18-24.
- ¹⁴⁰ Confidential Coffs Harbour hearing, transcript 24.3-11.
- ¹⁴¹ NSW Health briefing, 4 April 2008, transcript 84.41-85.1.
- ¹⁴² Confidential Bankstown hearing, transcript 64.7-10.
- ¹⁴³ Confidential Armidale hearing, transcript 6.2-3.
- ¹⁴⁴ Confidential Armidale hearing, transcript 6.4-7.
- ¹⁴⁵ Confidential Armidale hearing, transcript 6.9-13.
- ¹⁴⁶ Paul Mesher, Port Macquarie Hearing, 28 March 2008, transcript 1074.21-30.
- ¹⁴⁷ Confidential hearing at the Inquiry's offices via video-link from Wagga Wagga, 30 May 2008, transcript 11.32-35.
- ¹⁴⁸ Confidential hearing at the Inquiry's offices via video-link from Wagga Wagga, 30 May 2008, transcript 11.37-40.
- ¹⁴⁹ Confidential Royal Prince Alfred Hospital hearing, 20 May 2008, transcript 18.9-17.
- ¹⁵⁰ Confidential Royal Prince Alfred Hospital hearing, 20 May 2008, transcript 19-23.
- ¹⁵¹ Confidential Bankstown hearing, 13 May 2008, transcript 35.44-46.
- ¹⁵² Confidential Bankstown hearing, 13 May 2008, transcript 36.1-10.
- ¹⁵³ Confidential Bankstown hearing, 13 May 2008, transcript 47.20-23.
- ¹⁵⁴ Anne Sinclair, Wollongong hearing, 14 April 2008, transcript 1663.16-18.
- ¹⁵⁵ Anne Sinclair, Wollongong hearing, 14 April 2008, transcript 1664.4-17.
- ¹⁵⁶ Anne Sinclair, Wollongong hearing, 14 April 2008, transcript 1664.35-1665.17.
- ¹⁵⁷ Anne Sinclair, Wollongong hearing, 14 April 2008, transcript 1665.25-27.
- ¹⁵⁸ Confidential Westmead hearing, 26 May 2008, transcript 62.28-29.
- ¹⁵⁹ Confidential Westmead hearing, 26 May 2008, transcript 63.1-6.
- ¹⁶⁰ Anne Frew, Wollongong hearing, 14 April 2008, transcript 1645.28-39.
- ¹⁶¹ Anne Frew, Wollongong hearing, 14 April 2008, transcript 1645.36-39.
- ¹⁶² Paul Mesher, Port Macquarie hearing, 28 March 2008, transcript 1074.30-43.
- ¹⁶³ Alan Pretty, Port Macquarie hearing, 28 March 2008, transcript 1116.1-16.
- ¹⁶⁴ Alan Pretty, Port Macquarie hearing, 28 March 2008, transcript 1116.4-6.
- ¹⁶⁵ Susan McNeill, John Hunter Hospital hearing, 12 May 2008, transcript 2750.44-2751.1.
- ¹⁶⁶ Confidential Mudgee hearing, 20 March 2008, transcript 8.32-38.
- ¹⁶⁷ Confidential Mudgee hearing, 20 March 2008, transcript 8.39-41.
- ¹⁶⁸ Confidential Mudgee hearing, 20 March 2008, transcript 9.4-11.
- ¹⁶⁹ Angela Monger, Gosford hearing, 10 March 2008, transcript 149.29-37.
- ¹⁷⁰ Confidential hearing at the Inquiry's offices via video-link from Wagga Wagga, 30 May 2008, transcript 15.29-32.

-
- ¹⁷¹ Confidential hearing at the Inquiry's offices via video-link from Wagga Wagga, 30 May 2008, transcript 15.33-41.
- ¹⁷² Confidential St George Hospital hearing, 14 May 2008, transcript 36.26-33.
- ¹⁷³ Confidential St George Hospital hearing, 14 May 2008, transcript 36.35-37.
- ¹⁷⁴ Confidential St George Hospital hearing, 14 May 2008, transcript 37.3-11.
- ¹⁷⁵ Confidential Prince of Wales Hospital hearing, 20 May 2008, transcript 18.9-17.
- ¹⁷⁶ Information provided during visit to Braidwood Multipurpose Service on 15 April 2008.
- ¹⁷⁷ Information provided during visit to Braidwood Multipurpose Service on 15 April 2008.
- ¹⁷⁸ Information provided during visit to Ballina Hospital on 28 April 2008.
- ¹⁷⁹ Confidential Armidale hearing, 26 March 2008, transcript 6.29-37.
- ¹⁸⁰ Pamela Barrett, Tweed Heads hearing, 29 April 2008, transcript 2387.32-39.
- ¹⁸¹ Amanda Short, Coffs Harbour hearing, 27 March 2008, transcript 950.10-12.
- ¹⁸² Amanda Short, Coffs Harbour hearing, 27 March 2008, transcript 950.12-13.
- ¹⁸³ Amanda Short, Coffs Harbour hearing, 27 March 2008, transcript 950.32-36.
- ¹⁸⁴ Kerry Shanahan, Mudgee hearing, 20 March 2008, transcript 751.35-37.
- ¹⁸⁵ Confidential Armidale hearing, 26 March 2008, transcript 6.19-23.
- ¹⁸⁶ Confidential Armidale hearing, 26 March 2008, transcript 6.2-3.
- ¹⁸⁷ Confidential Armidale hearing, 26 March 2008, transcript 6.25-27.
- ¹⁸⁸ In this regard, see the evidence of Andrea Delprado, Liverpool hearing, 17 April 2008, transcript 1888.37-42.
- ¹⁸⁹ Letter from NSW Health to Special Commission of Inquiry, 4 September 2008.
- ¹⁹⁰ Letter from NSW Health to Special Commission of Inquiry, 4 September 2008.
- ¹⁹¹ Submission of NSW Nurses' Association, September 2008, SUBM.095.0001 at 29.
- ¹⁹² Wendy Smith, Liverpool hearing, 17 April 2008, transcript 1835.1-3.
- ¹⁹³ Jan-Marie Tweedie, Royal North Shore Hospital hearing, 14 March 2008, transcript 313.10-12.
- ¹⁹⁴ Jan-Marie Tweedie, Royal North Shore Hospital hearing, 14 March 2008, transcript 313.12-13.
- ¹⁹⁵ Confidential hearing at the Inquiry's offices via videolink, 13 June 2008, transcript 17.43-18.7.
- ¹⁹⁶ Confidential hearing at the Inquiry's offices via videolink, 13 June 2008, transcript 18.9-13.
- ¹⁹⁷ Confidential hearing at the Inquiry's offices via videolink, 13 June 2008, transcript 18.15-17.
- ¹⁹⁸ Wendy Smith, Liverpool hearing, 17 April 2008, transcript 1837.23-27.
- ¹⁹⁹ Confidential Bankstown hearing, 13 May 2008, transcript 95.30-38.
- ²⁰⁰ Susan French, Coffs Harbour hearing, 27 March 2008, transcript 987.23-32.
- ²⁰¹ Phyllis Davis, Prince of Wales Hospital hearing, 1 May 2008, transcript 2518.28-38; see also the submission of Phyllis Davis, 1 May 2008, SUBM.022.0262 at 2.
- ²⁰² Andrea Delprado, Liverpool hearing, 17 April 2008, transcript 1889.41-1890.16.
- ²⁰³ Submission of NSW Nurses' Association, September 2008, SUBM.095.0001 at 31.
- ²⁰⁴ Amanda Short, Coffs Harbour hearing, 27 March 2008, transcript 950.21-26.
- ²⁰⁵ See, for instance, the evidence of Andrea Delprado, Liverpool hearing, 17 April 2008, transcript 1890.18-20.
- ²⁰⁶ Peter Campbell, Royal North Shore Hospital hearing, 2 April 2008, transcript 1196.26-30.
- ²⁰⁷ Peter Campbell, Royal North Shore Hospital hearing, 2 April 2008, transcript 1196.35-37.
- ²⁰⁸ Peter Campbell, Royal North Shore Hospital hearing, 2 April 2008, transcript 1196.37-40.
- ²⁰⁹ Peter Campbell, Royal North Shore Hospital hearing, 2 April 2008, transcript 1196.40-43.
- ²¹⁰ Helen Harwood, Mudgee hearing, 20 March 2008, transcript 715.26-31.

-
- 211 Submission of NSW Nurses' Association, September 2008, SUBM.095.0001 at 31.
- 212 Meeting with Hospital Reform Group, 23 May 2008.
- 213 Submission of David Rhodes on behalf of the Hunter New England Area Health Service Area Allied Health Committee, 20 May 2008, SUBM.049.0074 at 77; submission of the Prince of Wales Hospital Physiotherapy Department, 1 May 2008, SUBM.029.0505 at 6; submission of Patricia Bradd, 28 March 2008, SUBM.002.0177 at 178.
- 214 Meeting with the Society of Hospital Pharmacists of Australia, 27 June 2008.
- 215 NSW Health, *NSW Health Service Health Professionals (State) Award*, IB2007_059; *Public Hospitals (Professional and Associated Staff) Conditions of Employment (State) Award*; *Health Industry Status of Employment (State) Award*.
- 216 See NSW Psychologists Education Board, *Registration Information Kit*, January 2004, Sydney [response to summons – NSCC.020.0147].
- 217 Submission of the Prince of Wales Hospital Physiotherapy Department, 1 May 2008, SUBM.029.0505.
- 218 Submission of Patricia Bradd, 28 March 2008, SUBM.002.0177 at 178
- 219 See, for example, Professor Michael Cousins, Royal North Shore Hospital hearing, 14 March 2008, transcript from 344.5 and Dr Leonie Watterson, Royal North Shore Hospital hearing, 14 March 2008, transcript from 431.34.
- 220 Dr Leonie Watterson, Royal North Shore Hospital hearing, 14 March 2008, transcript 432.4.
- 221 Dr Leonie Watterson, Royal North Shore Hospital hearing, 14 March 2008, transcript 432.29.
- 222 Information provided during visit to Sydney Medical Simulation Centre on 20 July 2008.
- 223 Information provided during visit to Sydney Medical Simulation Centre on 20 July 2008.
- 224 Dr Leonie Watterson, Royal North Shore Hospital hearing, transcript 434.9.
- 225 Submission of Dr Andrew Pesce, Westmead Medical Staff Council Westmead, SUBM.013.0089, 4.
- 226 Dr Leonie Watterson, Royal North Shore Hospital hearing, 14 March 2008, transcript 431.9, 434.46.
- 227 Meeting with the Institute of Medical Education and Training, 3 April 2008, transcript 81.6
- 228 Information provided during visit to Walgett Health Service, 9 May 2008; Confidential Sydney Children's Hospital hearing, 19 May 2008, transcript 54.38.
- 229 For example, Professor Saul Freedman, Concord hearing, 24 April 2008, transcript 2182.17-35.
- 230 Meeting with the Society of Hospital Pharmacists of Australia, 27 June 2008.
- 231 Professor Anthony McLean, Nepean Hospital hearing, 8 April 2008, transcript 1463.44.
- 232 NSW Health briefing, 4 April 2008.
- 233 NSW Health briefing, 4 April 2008.
- 234 Confidential Bourke Hospital hearing, 9 May 2008, transcript 12.08.
- 235 Meeting with the Australian Health Policy Institute, 11 April 2008.
- 236 Meeting with the Australian Health Policy Institute, 11 April 2008.
- 237 Meeting with the Royal Australasian College of Physicians, 24 June 2008.
- 238 Associate Professor Theresa Jacques, St George Hospital hearing, 14 May 2008, transcript 2881.28.
- 239 Associate Professor Theresa Jacques, St George Hospital hearing, 14 May 2008, transcript 2881.28.
- 240 Andrea Delprado, Liverpool hearing, 17 April 2008, transcript 1886.
- 241 Andrea Delprado, Liverpool hearing, 17 April 2008, transcript 1892.01-07, 12-14.
- 242 Dr David Mayer, expert conference 15 September 2008.
- 243 Dr Andrew Keegan, Nepean Hospital hearing, 8 April 2008, transcript 1412.04.
- 244 Dr Andrew Keegan, Nepean Hospital hearing, 8 April 2008, transcript 1413.

²⁴⁵ Van Der Weyden, M, "Challenges and change in medical training: the Australian Curriculum Framework for Junior Doctors" (2007) 186(7) Medical Journal of Australia 332.

²⁴⁶ Dr Roslyn Crampton, Westmead hearing, 10 April 2008, transcript 1517.30-1518.26.

11 Workforce reforms

Lack of support staff	364
Lack of administrative support staff for clinicians.....	365
Lack of administrative support staff for management.....	371
Pressure on administrative staff.....	372
Clerical support in the Emergency Department.....	372
False economy.....	374
Clinical support officers.....	375
Administrative support for Nurse Unit Managers.....	378
Ward clerks.....	378
Wardspersons & cleaners.....	380
Rostering	383
Safety issues.....	384
Access block.....	386
Safe and congenial working hours.....	388
The way forward.....	389
Nightshift culture.....	390

- 11.1 In this chapter, I will discuss a number of workplace practices operating throughout NSW public hospitals which appear to me to reduce the effectiveness of our health professionals, have the potential to endanger patient safety and undermine equality of access to health services. Those practices are:
- (a) inadequate support staff for health professionals; and
 - (b) rostering health professionals largely within business hours only.
- 11.2 I have separately discussed in Chapter 6 the grossly uneven distribution of the limited workforce of health professionals across the State, and how this might be remedied.
- 11.3 I have also discussed in Chapter 15 how technology may be better used to improve the working conditions of the clinical workforce, for example, by the provision of modern pagers and personal digital assistants.
- 11.4 I have made some recommendations as to which of these workplace practices should be redressed, and how. As some of the changes will have a major impact on how health professionals work, the implementation of my recommendations requires further consultation with health professionals to work out the details and ensure that the changes are sustainable. However, it is important that changes do occur.

Lack of support staff

- 11.5 A recurring theme in my review of the workforce – doctors, nurses, allied health and pharmacy – is the complaint by health professionals that they spend undue amounts of time on administrative tasks which could more efficiently and cost-effectively be done by support staff.
- 11.6 In the last 4-5 years, NSW Health has made widespread reductions in expenditure in administrative areas with a view to investing in clinical areas.¹ Whilst some of these cuts may have been appropriate, they appears to me to have gone too far and the position has been reached where this is now actually costing the State money in the sense that health professionals are now taken away from their core clinical duties to attend to administrative tasks.
- 11.7 As the following table and figure demonstrate, while the number of hospital support workers (including ward clerks, public health officers, patient enquiries officers and other support staff) has increased slightly over the last 5 years, the number of corporate administration staff (including hospital executives, information technology staff, and human resources and finance staff) has been reduced.²

Table 11.1 Corporate Administration and Hospital Support Workers 2002/03 to 2007/08

	Corporate Administration FTE	Hospital Support Workers FTE
2002/03	5,441	9,933
2003/04	5,469	10,037
2004/05	5,038	10,723
2005/06	4,666	10,709
2006/07	4,593	11,244
2007/08	4,476	11,649

Source: NSW Health Annual Reports (2007/08 Preliminary data)

Corporate Administration and Hospital Support Workers 2002/03 to 2007/08

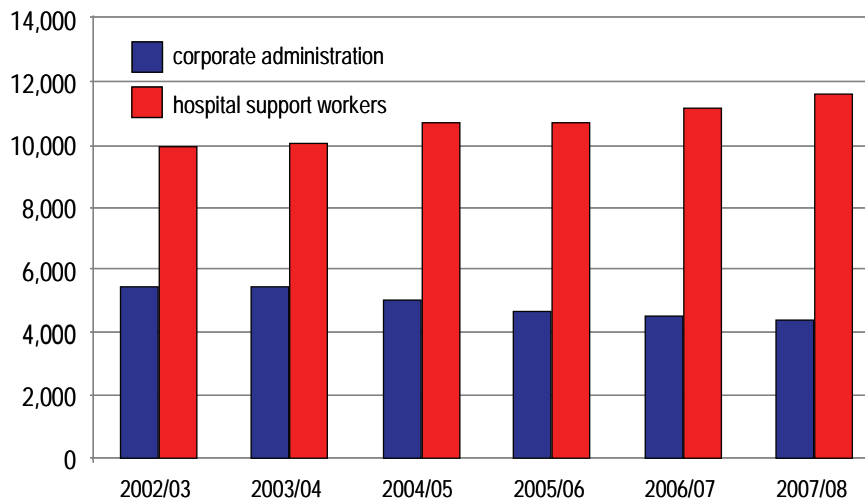

Source: NSW Health Annual Report (2007/08 draft unaudited)

Notes: Data has been provided by the NSW Department of Health, Ambulance Service of NSW, Health Support Services and NSW Area Health Services.

Corporate Services includes hospital executives, information technology, human resource and finance staff. Hospital Support Workers includes ward clerks, public health officers, patient enquiries and other clinical support staff.

Data for Health Support revised following audit of administrative staff which indicated a number of hospital support workers were incorrectly coded.

Lack of administrative support staff for clinicians

Doctors

- 11.8 Doctors across NSW told me that because of a lack of administrative support they spend considerable amounts of time attending to a wide range of clerical and administrative tasks that do not require medical knowledge.
- 11.9 For instance, an intensive care senior registrar at Prince of Wales Hospital made the following comments in the context of the limited clerical support provided to clinicians:
- "There is certainly no significant clerical support for medical officers in the public hospital system, and a large amount of doctors' time is spent chasing clerical and administrative tasks, which is not made any easier by the antiquated information management systems that are common in the public health system such as paper-based medical records, test ordering and results, multiple incompatible and unfriendly computer interfaces, and film based x-rays and scans that are still common in many hospitals."³
- 11.10 The Medical Staff Council at Westmead Hospital submitted that a significant loss of valuable time arose when doctors "chased" results – in particular, diagnostic images.⁴ The Council told me that much of junior medical officers' time is spent on clerical tasks such as collecting x-rays, and delivering and coordinating test results.⁵ The Council stated that although a few of those tasks do contribute to training, non-clinician clerical staff could perform many of them were it not for the fact that "such staff have long been removed for non-medical budgeting" reasons.⁶

- 11.11 A representative of the Institute of Medical Education and Training told me, ward clerks need to be valued in our public health system, as they take away a lot of the clerical tasks that junior medical officers should not be doing, and thereby permit junior medical officers to deal with basic medical issues.⁷
- 11.12 The Director of Clinical Operations at Sydney Children's Hospital made the following comments on the changes to administrative arrangements brought about by the restructuring of administrative services:
- "The positive process of standardisation has, unfortunately, also been clouded by the parallel changes within the system, such as centralisation and service reductions. This restructuring has at times been unhelpful, even counter-productive. The best examples of this would be in areas of human resources management and financial support for clinicians where staffing reductions have, in my perception, compromised the system's performance unnecessarily. Having said that, it is difficult to support those perceptions with any evidence, as the evaluation processes to monitor these changes have been less than ideal."⁸
- 11.13 When I met with representatives of the Australian Medical Association ("AMA") and the Australian Salaried Medical Officers Federation ("ASMOF"), I was directed to the results of a 2008 survey by the Workplace Research Centre at the University of Sydney, jointly commissioned by the AMA, ASMOF and the NSW Nurses' Association, which highlighted clinicians' concerns about the lack of administrative support.⁹ I was told that although NSW Health had managed to maintain the number of professional-level positions, it had reduced the level of administrative support: professionals have therefore been filling the administrative "gap".¹⁰
- 11.14 62.4% of staff who responded to the survey had seriously considered leaving the public health system in the previous 12 months, and this figure was reportedly consistent across all groups surveyed.¹¹ From a "menu" of items that would encourage them to stay in this system, senior doctors identified "greater recognition/respect for the work I do from management" (45-50%) and "improved secretarial/administrative support" (43-46%) as the key factors.¹² 75% of all doctors responded that the "provision of clinical support staff" was sub-standard, and this figure was found to be significantly higher amongst Emergency Department doctors and nurses.¹³

Nurses

- 11.15 Nurses also expressed concern about the significant amount of administrative and other "non-nursing" work they are required to do. The following nurse's comments were typical:
- "...I think if administrators start looking towards nurses nursing, I know from our point of view, we do a lot of unnecessary non-nursing duties in the hospital, cleaning, et cetera and if they can put the unskilled people in to do the cleaning - you know, we're paid to do stores and stuff like that. If you free the nurses up from doing the stores and the cleaning and all the unnecessary nursing duties, the nurses have got more time to be nurses and there will probably be a lot more satisfaction in actually being able to come to work and do the job that you're trained to do, rather than come to work and clean and be a secretary and not get to see your patient for a whole day because you're busy [with] all those other non-nursing things."¹⁴

11.16 The NSW Nurses' Association told me that an inadequate supply of support staff results in a substantial increase in the workload of nurse and midwives, and also distracts them from their primary objective of delivering quality nursing and midwifery care.¹⁵ I accept the Association's submission that:

"It is simply unrealistic to expect that nurses and other front-line clinicians can deliver quality care in a managerial or support vacuum."¹⁶

11.17 I have discussed, in detail, the administrative burden borne by nurse unit managers by reason of a lack of administrative support in Chapter 8.

11.18 I note that the abovementioned survey by the Workplace Research Centre found that although nurses were less scathing than doctors about the adequacy of resources in public hospitals, 56% of nurse respondents reported that there was "poor" or "inadequate" provision of clinical support staff.¹⁷

11.19 I commonly encountered such complaints during the course of the Inquiry.

- A nurse unit manager at Mudgee Hospital told me that there is a lack of clerical support for nurses, who are required to spend time filing, coding and chasing codes and dockets, resulting in time being taken away from direct or indirect patient care.¹⁸
- Nurses at Mona Vale Hospital told me that there was no support and if it was available, it would help nurses concentrate on their clinical responsibilities.¹⁹
- During my visit to Royal Prince Alfred Hospital I was told that the nurse unit manager in the Emergency Department spends 40% to 60% of her time on administrative work – preparing rosters, wage sheets, and other paperwork – rather than "hands on" caring for patients.²⁰
- A nurse at Wagga Wagga Base Hospital told me that the amount of non-nursing duties that nurses are being asked to do is impacting upon nursing staff and their delivery of patient care.²¹ She said that due to a lack of clerical support nurses are asked to pack away meal trays, answer telephones and doorbells, photocopy, and make patient appointments.²²
- One of her colleagues at Wagga Wagga confirmed that the absence of clerical support meant that nursing staff are sometimes required to take out the garbage bins.²³
- A witness from The Tweed Hospital told me that the clinicians there really want their administrative support back so they can undertake clinical work and not spend their "higher paid time" doing menial tasks.²⁴ The witness observed that by getting rid of administrative staff, the hospital now has senior clerical staff and nurse unit managers undertaking payroll duties.²⁵ The witness told me that this was not a good use of money or resources, particularly given the scarce nursing workforce.²⁶

11.20 Midwives seem to suffer particularly in this regard. I heard evidence that midwives are left to attend to a number of non-delivery tasks in delivery suites, which are both menial and physically exhausting.

11.21 For instance, a midwife at Wollongong Hospital told me that in the birth unit, midwives have to clean the beds after a woman has given birth.²⁷ If the midwives run out of towels, they are required to go to the basement of the hospital, get a large, heavy trolley, fill it with towels and bring it back to the ward area.²⁸ She told me that the midwives do not have any support staff to do this for them.²⁹ One solution that was put forward to deal with staffing and workload issues was that auxiliary staff – such as ward clerks, cleaners, support staff and porters – be employed.³⁰ At the time of the witness'

evidence, however, this had not happened.³¹ It seems to me that provision of adequate ancillary services is essential to make the most of the midwives we do have.

- 11.22 Given the shortage of experienced nurses, it is obviously important to ensure that nurses are free to nurse. In this regard, Professor Cliff Hughes, the Chief Executive Officer of the Clinical Excellence Commission, reinforced the need for NSW Health to free up nurses to enable them to undertake nursing duties, rather than having them prepare reports and rosters.³²

Improving nurses' clinical productivity

- 11.23 I have been told that the United Kingdom's National Health Service ("NHS") Institute for Innovation and Improvement developed The Productive Ward Program, which examines how to systematically improve nurses' productivity and delivery of care in an acute hospital ward setting.³³ The program aims to increase the amount of nurses' time spent on direct patient contact, improve patients' experience and outcomes, increase safety, and improve patient flow.³⁴

- 11.24 Through a series of training modules, the program trains nurses to undertake a time and motion study of their work on the ward.³⁵ The first training module – "The Well Organised Ward" – encourages nurses to work in a standardised way.³⁶ This module requires nurses to consider how their wards are organised, with a view to developing standard operating procedures and auditing compliance with those standards.³⁷ The second module – "Knowing How We're Doing" – requires wards to set their own goals in areas such as infection rates and falls, and measure performance against those goals.³⁸

- 11.25 I understand that to implement The Productive Ward Program, the ward manager needs to spend 50% of his or her time for up to 6 months rolling the system out in their ward.³⁹ It is thus necessary for hospital management to support this and to provide the ward with alternate staff.⁴⁰ A representative of the NHS informed me that the program has delivered positive results in Nottingham University Hospital and Central Manchester Hospital.⁴¹ It may be that this program could provide significant guidance to NSW Health on how to release nurses to direct patient care and maximise nurses' productivity on the wards of our public hospitals.

- 11.26 I note that NSW Health's "Essentials of Care" program is presently examining what is happening at the ward level in a variety of areas of practice, including documentation, communication, bloods and IVs, privacy and dignity, clinical interventions, hand washing and recognition of the deteriorating patient.⁴² The program aims to "work out" what is happening in the clinical unit.⁴³ A facilitator, who is usually external to the unit, and another external observer – usually someone from a similar ward – observe what is happening, on the ward.⁴⁴ Internal observers are also used.⁴⁵ I was told that these observers:

"...look over a period of a week at the times of the day that the people from the ward think that it would be best for them to look at particular issues, like medication management or IV therapy or personal hygiene ..."⁴⁶

- 11.27 The program also involves taking patient's stories.⁴⁷

- 11.28 In the preparation period, the facilitator works with staff to identify what they believe their values are.⁴⁸ (I was told that examples of those values include "safety", "teamwork", "integrity" and "communication").⁴⁹ The subsequent processes were described to me as follows:

"[The hospital staff] start mapping things against their values. If there are behaviours that are occurring in the ward that are at odds with their values, they either need to chuck the value, throw the value or they need to re-organise their behaviour around the value."⁵⁰

- 11.29 I was told that action plans are then developed⁵¹ following which staff dictate how long it will take to implement the plan.⁵² I have been informed that the program has been rolled at the Prince of Wales Hospital, Sutherland Hospital, St George Hospital and the Garrawarra Dementia Care Centre.⁵³
- 11.30 Like The Productive Ward Program, the Essentials of Care project is aimed at assisting clinical staff to identify ways in which productivity in the wards of our public hospitals can be maximised. The Productive Ward Program seems to me to be able to achieve more significant reforms and in a shorter time frame than does the Essentials of Care project. What is necessary is a review to ensure that the best features of both are combined into a program which can be used across the State to improve and make more efficient the operations of each ward.

Recommendation 38: *The Chief Nurse of NSW Health should supervise the preparation within 6 months of and ensure over a 2 year period the implementation of a program across all public hospitals in NSW which is designed to achieve an improvement in the efficiency and design of nursing work practices in each ward or unit having regard to the principles of shared care and team-based work practices. The NSW program should take into account the improvements made by the Productive Ward Program in the United Kingdom and the Essentials of Care Program.*

Allied health

- 11.31 I heard that like other health professionals, allied health staff suffer from the loss of business managers and clerical support. They struggle with information technology, electronic medical records and budgets without someone to ask for help.
- 11.32 For instance, I was told that without clerical and management support, allied health staff are expected to do these extra tasks in addition to their duties of performance management of staff, teaching, policy development, occupational health and safety and clinically supporting their staff and patients.⁵⁴
- 11.33 The Chief Executive Officer of the North West Slopes Division of General Practice submitted that there is a lack of sufficient administrative support for allied health and medical specialists in public hospitals: letters that have been dictated are often not typed for weeks, so the information does not get back to patients' GPs.⁵⁵

Administrative support and staff morale

- 11.34 Senior medical, nursing and allied health staff are increasingly burdened with tasks ordinarily done by business managers such as payroll, human resources, ordering statistics and financial management. It concerns me that these clinicians may not have the required skills and training to undertake these additional tasks. Having these valuable and experienced clinicians taken away from clinical duties is a waste of their expertise, reflects poor staff management, and lowers staff morale.
- 11.35 A neurologist and clinical academic at Liverpool Hospital spoke of the "enormous (sense) of frustration and despair" felt by clinicians because of the lack of clerical

assistance.⁵⁶ She made the following comments on the need for clerical support for clinicians, in the context of senior clinician morale:

"Why is it that at Liverpool quite a number of doctors left or have substantially reduced the amount of public work they do? So instead of being a full-time staff specialist, they have gone to part-time, and a lot of it, if you ask them, is due to being upset about various things and one of the most common issues is clerical assistance for senior doctors.

... Of course, we can have a doctor answering their own phone and typing their own letter and doing their own messages, but that is quite expensive, really."⁵⁷

- 11.36 She told me that she recently raised \$20,000 from a pharmaceutical company that knew she was having difficulties to enable her unit to employ some additional clerical support in order to function adequately.⁵⁸ Even then, it took over a year to employ the person although the funds were coming from outside NSW Health.⁵⁹ She told me that the delay had to do with the "cumbersome" administrative structures that attend the employment of staff.⁶⁰

Inadequate pay for administrative staff

- 11.37 I was informed that part of the problem is that NSW Health offers an inadequate pay structure for administrative officers, making it difficult to recruit and retain clerical staff.
- 11.38 To illustrate, a staff specialist at Concord General Repatriation Hospital told me that recruitment of clerical staff is cumbersome, time-consuming and unproductive, because of unrealistically low wages and poor prospects for advancement.⁶¹ In this context, he stated:

"The days when the lure of a permanent, that is, a tenured position at this level is enough to attract good-quality applicants have long gone, I think. There is a competitive marketplace for secretarial services against the backdrop of skill shortages and I don't think this has been recognised by the Department, and there needs to be a complete overhaul of salary and promotional structures for this particular group of people."⁶²

- 11.39 Another staff specialist at Concord told me that in the 8 years that she had been in her department, she and her colleagues had had to "repeatedly beg" for sufficient clerical staff to run their overbooked outpatient clinics.⁶³ She made the following comments:

"My colleagues and I consider ourselves to all be very lovely and reasonable people and we have failed to understand or comprehend the turnover of clerical staff in our department and our inability to recruit and retain staff, until we discovered that our frontline reception staff were on a salary, in current terms of \$34,000.

What capable receptionist with sufficient customer service skills to coordinate daily clinics of 40 sick and worried patients with leukaemia or other blood cancers would work for \$34,000? Within such a context, we so much better appreciated why, despite all our positive reinforcement, encouragement and appreciation of our clerical staff, anyone who is competent, anyone who is good, quickly moved on to a much better-paid position, either within the hospital or within the private sector..."⁶⁴

- 11.40 NSW Health has informed me that as at 1 July 2008, under the *Health Employees Administrative Staff (State) Award*, clerical staff (such as ward clerks) earn between \$39,979.20 and \$44,518.80 per annum.⁶⁵
- 11.41 Whilst NSW Health agreed that administrative support was needed for clinical managers, to free up their time for governance, patient safety and quality of care, NSW Health did not appear to regard this as necessary for all clinicians.
- 11.42 NSW Health told me that a recent survey concerning administrative processes in our public hospitals pointed to the significant administrative load borne by clinical managers, and cumbersome procedures and systems in areas such as recruitment.⁶⁶
- 11.43 A consultant to NSW Health told me that a new model of administrative support needs to be developed to assist managers at the clinical operational level in a shared corporate services environment.⁶⁷ He said that NSW Health, in cooperation with the area health services, needs to identify a source of funding for the new model and the cost of state-wide implementation.⁶⁸ He remarked that this is an investment in clinical management which will, in turn, free up clinical managers' time to enable them to provide better governance, patient safety and quality of care.⁶⁹
- 11.44 Clearly, the restoring of some sensible balance between clinical duties and day-to-day administrative chores will assist all health care professionals.

Lack of administrative support staff for management

- 11.45 Throughout the Inquiry, I also heard evidence of complaints from managers as to a lack of clerical support.
- 11.46 During my visit to Concord Repatriation General Hospital on 21 February 2008, I was informed that administration, infrastructure and business support at the hospital had been "gutted" by funding cuts.⁷⁰
- 11.47 A witness at Bankstown Hospital told me that clinicians in management positions require more clerical support.⁷¹ In her observation, there has been a rise in technology and the amount of computer work required to be undertaken, in circumstances where many clinicians do not have very good computer skills.⁷²
- 11.48 A witness at Lismore submitted that the reason for the amalgamation of the area health services was to produce administrative savings that would be re-distributed to clinical services.⁷³ The witness told me that the reality is quite different:

"What has been re-distributed to clinical service managers are many administrative tasks previously performed by dedicated administrative staff. This has been the only tangible outcome of the amalgamation of the Areas and reorganisation of corporate services. With the loss of local business managers and employee services officers, and the centralising of many administrative services in distance locations (eg Newcastle), the focus of clinical service managers is on administrative tasks rather than on clinical services management."⁷⁴

- 11.49 The Director of Medical Services at Orange Base Hospital made the following comments on the effect the reorganisation of the area health services has had on administrative processes:

"As part of a process of developing larger health service or creating larger health areas, there was the reduction in non-front-line staff. That has happened in Greater West, but part of the problem that we have is that the

staff that are processing things, are processing them for such a great area, that there is a significant time lag in much of that work. It's not because anyone is lazy or incompetent, it's just because there is a vast amount of work to do and only a relatively small number of people to do it."⁷⁵

- 11.50 A doctor at Concord told me that there is a shortage of senior health managers in the public hospital system, and the service is dependent upon a relatively small number of committed and competent individuals who are prepared to act as senior managers.⁷⁶ He said that the expanded health service model that had been implemented in recent years, while a "noble concept", had coincided with a reduction in support personnel for administrative services, and a decrease in the number of administrators.⁷⁷ He told me that this had resulted in a "stretching" of the administration structure, and may well have impacted negatively on the delivery of patient care.⁷⁸ He further observed:

"There is certainly a perception among senior clinicians that administrators at an area level are overwhelmed with work and that they can function only by dealing with immediate problems."⁷⁹

Pressure on administrative staff

- 11.51 The obvious corollary to the pressure on clinicians and managers by reason of a lack of support staff is the increased pressure on the limited number of support staff that are available. This was apparent from the evidence of a witness at Royal North Shore Hospital who told me that as a ward clerk, she was required to undertake a large range of duties, including dealing with doctors' enquiries in relation to patients, settling patients into their rooms, and administrative work.⁸⁰ I gained the impression from her evidence that she found it very difficult to adequately meet others' competing demands on her time given the breadth and volume of her tasks.

Clerical support in the Emergency Department

Lack of clerical support

- 11.52 Perhaps more than any other hospital department, I heard frequent complaints about the lack of clerical support in the Emergency Department. It makes sense to me that a lack of clerical support would be keenly felt here, given the level of intensity of this working environment.
- The Health Information Manager at Mudgee Hospital told me that the Emergency Department has no designated clerical staff, and only one medical records clerk.⁸¹ NSW Health client registration policy and guidelines require that patient and client registration occur in a timely manner.⁸² The witness informed me that there was about a 12 month backlog of registrations, and although staff were taking some limited measures to address this, the situation was unacceptable.⁸³
 - During my visit to the Emergency Department at Liverpool Hospital, I was told that clinicians spend too much time on non-clinical tasks.⁸⁴
 - A nurse at Bankstown Hospital told me that clerical (and wardsperson) vacancies take a very long time to fill.⁸⁵ The witness said that since the Emergency Department opened in 1996, it had never had a full complement of clerical staff.⁸⁶
- 11.53 A staff specialist at Hornsby Hospital told me that there was no secretary attached to the Emergency Department, but that such a person could provide the following assistance:

"They could take minutes of meeting(s) ..., they could type letters for us, they could help us get more organised in terms of structuring our time, our day when we are on administrative-type duties. ... [N]ot having had the benefit of a secretary at my command, I am sure they would be able to do things for me that I hadn't even thought of."⁸⁷

- 11.54 The nurse unit manager of the Emergency Department at Hornsby Hospital told me that the lack of available clinical time for nurse unit managers had demonstrable adverse effects on patient care. She stated:

"I think you need to have the nursing unit manager out there running the floor. All the nursing unit managers from all around the area will tell you that more and more they are stuck in the office doing what I would think is a secretarial-type job...[W]e have less time to do those things, like speaking to the public and helping them through a complaint."⁸⁸

- 11.55 In the context of patient care, one doctor stressed the importance of providing clinicians with appropriate levels of administrative support:

"Within individual hospitals, appropriate administrative support must be provided to allow senior clinical staff to focus on providing and guiding clinical care. For example, the current situation at [Prince of Wales Hospital] ED is that [nursing and medical staff] have as their only administrative support one full-time secretary. This requires virtually all staff to handle their own administrative load (regular staff performance reviews, rostering and leave management, policy development, preparing of meeting material and arranging meetings, documentation of appropriate processes, etc), as well as clinical load (patient follow-up and quality audits), severely limiting the time available for tasks actually requiring their clinical skills, in particular, teaching, training and care improvement initiatives."⁸⁹

- 11.56 The Director of the Emergency Department at Prince of Wales Hospital confirmed that her department has one secretary for approximately 200 staff, including 8 full-time equivalent staff specialists.⁹⁰ When the secretary took leave for 6 months, the witness was told that the secretary would not be replaced.⁹¹ The witness stated:

"We have no clerical support within the department for payroll management for our clinical staff, for stock management, for roster management, or for the work of recruitment of all our staff but particularly with respect to the junior medical staff recruitment which occurs once a year. This is a massive undertaking where we need to recruit ..., approximately 50 [full-time equivalent] doctors. This is a very difficult process without appropriate clerical support."⁹²

- 11.57 So too, the Area Director of Emergency Medicine for Northern Sydney Central Coast Area Health Service was of the view that Emergency Department efficiency can be improved by removing non-clinical duties from clinicians:

"There are ... efficiencies to be gained in terms of getting rid of frustrations like having our expensive, highly trained nurses and doctors answering the phone, labelling blood tubes and carrying them to pathology, restocking trollies, ... - all the things that don't need university educated people. It amounts to costing us \$2 every time the phone rings because we don't have a person answering the phone."⁹³

- 11.58 The conversations I had with clinicians during my visit to Royal Prince Alfred Hospital's Emergency Department on 14 February 2008 likewise pointed to the need for support staff to take the pressure off clinicians.⁹⁴
- 11.59 I understand that the main function of a ward clerk (sometimes referred to in the Emergency Departments as a "communications clerk") is to act as a conduit between medical, nursing, professional and clerical services within a hospital ward, including liaising with relevant staff in handling enquiries, making appointments and undertaking tasks concerning patients' medical records.⁹⁵
- 11.60 Perhaps in the Emergency Department more than anywhere else in the hospital, it is vital to appoint communications clerks to free up experienced doctors and nurses to attend to patients, rather than allowing their time to be taken up by administrative tasks. During my visits to many Emergency Departments, I was told that emergency specialists in particular are frequently taken away from important clinical tasks to perform duties that more junior clinicians or non-clinical support staff could carry out. I note that a study provided to the Inquiry confirmed that doctors in the Emergency Department are subject to high levels of interruption.⁹⁶
- 11.61 In my view, the Emergency Department in every tertiary hospital should have as part of the department a dedicated communications assistant who is responsible for answering telephone calls, paging people, organising tests and obtaining the results. Numerous Emergency Departments already have a communications clerk and all find it a valuable, time-saving resource.⁹⁷ Having a communications assistant frees up doctors' and nurses' time for clinical services and prevents diversion of their attention from direct patient care. Matching skill-sets to tasks in this way ultimately results in lower labour costs for the State.
- 11.62 I am told that no specific NSW Health criteria or guidelines for entitlement to communications clerks or other forms of administrative support in Emergency Departments have been developed.⁹⁸ NSW Health informed me that positions have traditionally been established on the basis of local identified need, and an available budget.⁹⁹ It seems to me that the present, ad hoc approach, is not working. Clear criteria for allocation of administrative positions must be developed to ensure that clinicians are adequately supported.

False economy

- 11.63 To my observation, there is a strange economy in operation in NSW public hospitals where highly trained and well paid professionals are taken away from clinical duties to complete paperwork, answer phones and run minor errands.
- 11.64 This does not make sense from a financial point of view. To translate this to other areas of commercial endeavour, it is like getting the partner of a law firm to file correspondence, or a company director to empty the dishwasher. They may do these things occasionally if the need arises, but it does not, and should not, occupy a sizeable proportion of every day.
- 11.65 Representatives of the Medical Staff Council at Wyong and Gosford Hospitals submitted that on a relative scale, positions such as patient service assistants, pathology staff and clerical staff are "cheap" compared to senior medical staff.¹⁰⁰ In this context, they stated:

"It does not make good business sense for higher-paid staff to be performing lower-paid roles, such as scribing and documentation, filling out forms, wheeling patients

to CT for an urgent test because there is no [patient services assistant] tea-break cover. These staff need to be freed up to do what they are trained and paid to do - assess and treat patients and make important clinical and disposition decisions" ¹⁰¹

- 11.66 The absence of support staff is even more ridiculous when one has in mind the shortages of experienced health professionals available to work in NSW public hospitals at all. The representatives of Wyong and Gosford Medical Staff Councils (quoted above) also suggested that appropriate resourcing of clinical staff would assist in freeing up the decision-makers and, in turn, help with more rapid progression of the patient through their hospital journey. ¹⁰²
- 11.67 In my view, when dealing with this issue, it is a case of muddled thinking leading to fundamental error to regard assistants who undertake tasks presently being done by senior clinicians, thereby freeing them up to attend to the clinical aspects of their roles , as being dispensable because they are not "front-line workers".
- 11.68 As ought to be plain in a complex system such as health, the delivery of services efficiently and in a cost effective manner, means that careful consideration needs to be given to identifying what the particular role or task is, and then allocating the role or task to a person appropriately skilled and experienced, but not over skilled, to perform the task. It seems to me to be a matter of common-sense that a team which is delivering front-line health care will need to have a membership which allows it to address the entirety of the care spectrum, of which the collection and collation of information is an integral part. That part can be carried out by someone with administrative skills probably better and, certainly, more cheaply than a staff specialist doing so. Yet the holder of the administrative skills are not regarded as part of the front-line team. This is a nonsense.
- 11.69 The restoration of an appropriate level of administrative support for clinicians and clinical leaders and managers is essential and urgent. It must be preceded by a review which identifies what the appropriate model is for the restoration of those workers to take place, particularly having regard to the use of modern IT based communication software.
- 11.70 I have dealt above with the need to move professional staff back to patient care by relieving them of administrative and clerical duties which have been dumped on them in recent times. This is simply a matter of proper use of existing structures.
- 11.71 Against this background, I propose to examine other potential support roles which may assist in remedying the present situation. In the next section I deal with the need to employ qualified people, who are not doctors, to perform tasks presently done by doctors. This new position is best described as a "clinical support officer", though it is sometimes referred to as a "physicians' assistant".

Clinical support officers

- 11.72 During the course of the Inquiry, I heard evidence from all levels of medical staff, starting with junior medical officers, as to the inordinate amount of time spent on simple procedures "historically" the domain of doctors, which could be done as efficiently and safely by a technically qualified clinical support officer, commonly referred to as a "physician's assistant".
- 11.73 As I understand the role, a clinical support officer could take blood, insert cannulas, arrange tests, follow up receipt of test results and undertake similar tasks. This would be particularly useful in the busy the Emergency Department environment.

- 11.74 In Emergency Departments across NSW, it was a common complaint of senior doctors that their ability to review patients was severely hampered by the amount of their time spent on “junior” tasks such as taking blood and organising tests. These complaints accorded with my own observations.
- When I visited Royal Prince Alfred Hospital, a senior doctor referred to his having answered the floor phone and then spending the next 15 minutes trying to locate the false teeth of a patient who had recently been discharged home.¹⁰³ I was told, and accept, that doctors commonly spend time doing such things, as well as following up X-ray and pathology results.
 - During my visit to Concord Repatriation General Hospital, I was told that about 15-20% of physicians’ time is productive.¹⁰⁴ Clinicians there said that junior medical officers, after seeing patients, spend “hours” booking tests, amongst other duties.¹⁰⁵
 - Whilst at St George Hospital, I was told that “bottle-necks” in the Emergency Department were often at the point of consultant/senior medical officer review.¹⁰⁶ I was informed that those doctors cannot see more than 8 patients an hour, but 30% of their time is spent doing “junior” work: for example, taking bloods and organising tests.¹⁰⁷
 - Clinicians from the Emergency Department at Liverpool Hospital also told me that they spend too much time on non-clinical tasks.¹⁰⁸ The Director of Medical Services at that department (quite sensibly) suggested that people needed to be assigned roles that use their particular expertise.¹⁰⁹
- 11.75 I regard it as a poor use of resources to have the senior doctor doing anything other than seeing patients and instructing junior clinicians as to patients’ care. A clinical support officer was frequently suggested as a way to free up the senior doctors for patient review.
- Clinicians at St George Hospital told me that one way to improve the patient’s journey from waiting room to ward would be to employ a technician or physicians’ assistant 24 hours per day to take bloods.¹¹⁰
 - Clinicians at Liverpool Hospital also told me that the appointment of physicians’ assistants would be a good idea.¹¹¹ It was suggested that the duties of physicians’ assistants could include the insertion of lines, and other tasks that “waste doctors’ time”.¹¹²
 - The Area Director of Emergency Medicine for Northern Sydney Central Coast Area Health Service also supported the idea of physicians’ assistants to take blood samples and perform IV cannulation.¹¹³
 - One doctor, on behalf of the Sutherland Emergency Department Staff Specialists, submitted that the Emergency Department could operate more efficiently through the establishment of physicians’ assistant positions to assist consultants.¹¹⁴
 - An Intensive Care Senior Registrar submitted that there is definitely a role for physicians’ assistants in emergency assessment: they could carry out doctors’ instructions and conduct procedures such as ordering x-rays and collecting results.¹¹⁵
- 11.76 Other witnesses suggested that nursing or other staff may be able to free up doctors’ time.
- An emergency physician at Sutherland Hospital, who trained in the United Kingdom, told me that nurses in England took all “non-doctor” tasks out of doctors’ hands.¹¹⁶ She said that working in the United Kingdom was not as stressful as working in Australia.¹¹⁷ In England, she saw 10 patients per hour (6 minutes per patient), and there was an average waiting time for patients of 20 minutes.¹¹⁸

- The Director of Medical Services at The Tweed Hospital told me that clerical or nursing support for medical staff would assist doctors to handle the administrative/managerial side of their role: for instance, informing staff where the doctor is.¹¹⁹
 - One emergency medicine specialist suggested that a variety of tasks presently performed by senior medical staff – including cannulation, wound care, splint application, setting up and clearing away procedure trolleys, and arranging investigations – could be undertaken by “limited skills” staff such as assistants-in-nursing, enrolled nurses and technical aides.¹²⁰
 - Other witnesses suggested that a final year medical student would be suitable for the clinical support officer role, or an overseas doctor awaiting acceptance of their qualifications by the Medical Board.¹²¹
- 11.77 Two emergency medicine specialists recommended that the following tasks and procedures ought be undertaken by nursing, technical or non-clinical support staff:
- wound dressings;
 - wound preparations, “set-up” for suturing and cleaning/cleaning of suture set-ups; and
 - ward re-stocking and equipment maintenance.¹²²
- 11.78 Interestingly, those 2 emergency medicine specialists told me about research jointly funded by NSW Health and the area health services in 2000-2001.¹²³ The project entitled “Emergency Department Workpractice Review Project” developed a model which had at its heart a flexible application of the various members to the entirety of the tasks to be done by reference to their skills, experience and competence, rather than by reference to traditional roles dominated by professional qualification.¹²⁴
- 11.79 The authors wrote that the trial of their project enabled them to conclude that having a communications clerk saved 34 hours of clinicians’ time in a week.¹²⁵ They designed a role which was called an Emergency Department Support Officer who undertook a range of non-clinical tasks such as transport, patient comfort tasks and restocking and helping with complex equipment set-up.¹²⁶ No doubt each Emergency Department would have slightly different configuration of those duties. The authors concluded that having the support officer saved 228 clinical hours per week.¹²⁷
- 11.80 I have not attempted to independently evaluate these results. It is sufficient for me to observe that they give clear support for that which seems to me to be common sense.
- 11.81 Even interns and junior doctors expressed concern that the majority of their time (up to 70%) was taken up with clerical duties, from which they learnt little. An assistant to perform these duties was suggested, as was an after-hours technician to take bloods.
- 11.82 To illustrate, a resident medical officer at Hornsby Hospital told me that the clerical responsibilities of junior clinicians – for instance, making phone calls, faxing, making arrangements for radiography appointments, and chasing up radiology – are excessive, detracting from direct patient care and the application of clinical knowledge.¹²⁸ She estimated that 60-70% of her time is taken up with such tasks when she works as part of a medical (as opposed to surgical) team.¹²⁹ She told me that she undertakes administrative work on behalf of all members of the team, and suggested that medical students and/or clerical assistants might be employed to undertake those duties.¹³⁰
- 11.83 A registrar at Westmead Hospital confirmed that interns do a lot of “service” work, such as chasing up x-rays, ringing patients’ doctors to obtain reports, ringing other hospitals for results, taking blood and inserting cannulas.¹³¹ She told me that if a team is busy, patients do not get their antibiotic or medication doses adjusted, because the junior

doctors do not have time to get to the patient to take blood or get to the cannula when antibiotics are due.¹³² She thought the solution to this problem was to have an after-hours team that is dedicated to taking blood, thereby enabling junior doctors to do more.¹³³ In this regard, she observed that it is not essential that cannulation be done by a doctor, as it could be performed by a technician.¹³⁴

- 11.84 In my view, a re-alignment of the NSW Health workforce is required to ensure that tasks are matched to a person's skill and level, and in recognition of the principles noted in the recommendations I have made below. As part of that re-alignment, positions should be created by NSW Health for "clinical support officers".

Recommendation 39: *The workforce at large of NSW Health be re-aligned so as to recognise the following principles:*

- (a) *each member of the clinical workforce should be prepared to work within a multi-disciplinary environment as a member of, or as a contributor to an inter-disciplinary team responsible for the delivery of patient centred care;*
- (b) *patient centred care is to be provided by a team, which allocates in accordance with the principles of "shared care", a component or components of care to a member of the team according to their qualifications and experience;*
- (c) *where a component or components of care can be provided, without adversely affecting patient care as measured by the patient care performance criteria, by*
 - (i) *IT based remote support; or*
 - (ii) *by a less well, but nevertheless suitably qualified member of the team; or*
 - (iii) *by a private provider of health services,**then NSW Health is free to designate one of these alternatives for the provision of care.*
- (d) *a real need exists in times of a national health workforce shortage for clinical support staff to be employed to undertake tasks for which they are suitably qualified so as to allow senior clinicians, in particular, to be freed up to attend to those components of patient care which require their other skills*

Administrative support for Nurse Unit Managers

- 11.85 I have separately dealt with the need to provide administrative support in the form of a clinical assistant for nurse unit managers in Chapter 8.

Ward clerks

- 11.86 At present, a valuable (and sometimes only) form of administrative support is the ward clerk. Ward clerks' duties include the maintenance of patient notes, chasing medical records and test results, chasing x-rays, doing discharges, doing computer work and answering patient enquiries.¹³⁵ A nurse at Tamworth Hospital told me that ward clerks are used there in ward areas, but some are not full-time.¹³⁶ She said that there was a lack of continuity in the staff who acted as a ward clerk in the unit in which she worked.¹³⁷ She said that ward clerks at that facility undertake paperwork concerning the

general running of the ward: they do not do rosters or managerial tasks, although a ward clerk could be tasked with rostering, subject to a proper definition of their job description.¹³⁸

- 11.87 It seems to me that this resource is not available to nurses as often as it should be, particularly given that ward clerks are paid approximately half as much as nurse unit managers.¹³⁹
- 11.88 Evidence given before me suggests that ward clerks are often not back-filled when they take leave, in what appears to be an attempt to save money.
- A clinical nurse specialist at Liverpool Hospital confirmed that when ward clerks take holidays, their positions may not be back-filled, depending on the ward.¹⁴⁰
 - A nurse at Bankstown Hospital also complained that ward clerks are not always back-filled when they take leave, which impacts upon nursing staff.¹⁴¹
 - A witness at Wollongong Hospital told me that on the maternity wards, acuity rates have increased and they are required to look after younger babies whom the neonatal unit no longer looks after.¹⁴² If the ward clerk is away sick, however, she is never replaced.¹⁴³ The witness cited, as an example, the fact that the ward clerk recently broke her foot, was off work for 4 weeks, and was only replaced for 1½ weeks during that period.¹⁴⁴ Nursing staff were thus required to “take up the slack”.¹⁴⁵
- 11.89 Ward clerks and general clerical assistance often appear to be scarce or non-existent during afternoon and evening shifts.
- Nurses at Bankstown Hospital informed me that ward clerks there typically work from 8.00 am to 4.30 pm, and that after-hours they are shared by multiple wards on a “first in, best dressed” basis.¹⁴⁶
 - A witness at Port Macquarie told me that she has access to one ward clerk from 6.30 am to 3.30 pm, Mondays to Fridays and for 4 hours on Saturday and Sunday.¹⁴⁷ She said that she requires an evening ward clerk, as the ward becomes extremely busy in the evening and her staff are constantly trying to manage telephone calls.¹⁴⁸
 - A midwife at Wollongong Hospital told me that there was no ward clerk on the weekends in the maternity unit, and there was no ward clerk available in the birth unit.¹⁴⁹ She said that as a result, nursing staff are taken away from direct patient care.¹⁵⁰
 - During my visit to Macksville Hospital I was also told that there was no clerical person available in the afternoons or evenings, and no funding for what the hospital does have by way of clerical support.¹⁵¹
 - Representatives of The Children’s Hospital at Westmead told me that the ICU has clerical assistance 7 days a week, 8 am to 4.30 pm, and shares a clerical assistant after hours; however, the evenings can be a very busy time for visitors.¹⁵²
 - A witness at Liverpool Hospital said that she would be much assisted by the presence of a ward clerk after-hours.¹⁵³ This would take nurses away from the administrative responsibilities, such as answering phones and getting patients’ notes organised, that divert nurses from direct patient care.¹⁵⁴
 - A nurse at The Tweed Hospital told me that on her ward, there is a lack of out-of-hours services such as clerical support.¹⁵⁵ She said that after-hours, usually the most senior nurse on the ward tries to complete the clerical duties as well as attend to the sickest patients.¹⁵⁶ The senior nurse is also responsible for overseeing junior staff.¹⁵⁷

- 11.90 The Acting Director of Nursing and Midwifery at Royal North Shore Hospital told me that that hospital has no after-hours ward clerk support.¹⁵⁸ She said that the lack of after-hours coverage generally this was an issue:

"We have noticed that a lot of our sick patients deteriorate after hours because people are not around to pick up the fact that they are deteriorating and because of the lack of support after hours."¹⁵⁹

- 11.91 She expressed the same concerns in relation to night shifts, observing that the service appears to cater to patients Monday to Friday, 9.00 am to 5.00 pm – despite that fact that patients and nurses are at hospital 24 hours a day – yet nurses are not provided with any support after-hours.¹⁶⁰

- 11.92 A registered nurse at Mudgee Hospital told me that lack of clerical support after-hours impacts dramatically upon nursing staff.¹⁶¹ She stated:

"It is noted that presentations to the emergency department and admissions to the ward are dramatically increasing at this facility due to an increase in the area's population and lack of doctors at other facilities within the area. Having to juggle acute care needs of patients and administrative duties, such as IPM access, medical record retrieval and simplistic tasks such as answering the phone can radically reduce the time that nursing staff can allocate to attend to acute care needs and documenting thoroughly and effectively the clinical notes."¹⁶²

- 11.93 A nurse unit manager at John Hunter Hospital also raised concerns about the lack of after-hours ancillary support for nursing staff:

"Clerical support – ward clerks, they finish, depending on what unit, between 3 and 4 o'clock. You can always guarantee, I have done it myself, sat there and answered phones for an hour non-stop after the ward clerk has gone home. When there is no-one there to answer the phones then it is the nursing staff again – and it does not matter what skill level they are, they can be [enrolled nurses], anyone, answering phones, and it is taking them away from direct patient care. You can field 40 or 50 phone calls in the space of an hour."¹⁶³

- 11.94 This witness told me that most of these sorts of calls could be dealt with by a ward clerk or an administrative assistant.¹⁶⁴

- 11.95 I make recommendations below about the position of a clinical support officer. Funding should be allocated to ensure that these positions are back-filled when staff take leave.

Wardspersons & cleaners

- 11.96 I understand that a wardsperson's primary responsibilities are patient transfer and the provision of assistance to clinical staff within the limits of the wardsperson's skills and knowledge base.¹⁶⁵ No formal qualifications are required for appointment as a wardsperson, as training is provided on-the-job.¹⁶⁶

- 11.97 Cleaners, referred to in the hospital system as "hospital assistants", are responsible for all cleaning duties, including the removal of general waste, floor maintenance and the tidying of wards.¹⁶⁷ Appointment to a hospital assistant position requires experience in the use of industrial cleaning equipment.¹⁶⁸

- 11.98 The primary responsibilities of “health and security assistants” are cleaning duties and security support as required.¹⁶⁹ Health and security assistants require a 1A security licence, a first aid certificate and experience in the use of industrial cleaning equipment.¹⁷⁰
- 11.99 I heard evidence on a fairly regular basis that there are not enough wardspersons and cleaners available in hospitals, with the result that nurses attend to their duties.
- 11.100 The Acting Director of Nursing and Midwifery at Royal North Shore Hospital was of the view that appointing one wardsperson per ward would provide some assistance.¹⁷¹ She told me that wardspersons are shared throughout the hospital, so it is not always possible to get assistance at the time it is required – for instance, to move somebody out of bed.¹⁷²
- 11.101 A nurse at Bankstown Hospital described the impact of a lack of wardspersons on the availability of hospital equipment in the following terms:
- “[I]f the wardsperson is doing their job and trying to get patients transferred, we might have equipment that we need to transfer for repair and often that is left. Of course it is a lower priority. That might take a couple of days for us to arrange transport, and say, ‘we have this equipment here and it will take a while’, so it is a delay in equipment being fixed or taken to another ward area, wherever it needs to go.”¹⁷³
- 11.102 One of her colleagues told me that problems can be exacerbated by the fact that the transport service does not run errands within the hospital: for instance, collecting sandwiches for patients who have returned from theatre, or picking up something from the pharmacy.¹⁷⁴ The nurse from Bankstown (quoted above) told me that a lack of wardspersons can cause delays in patient movements:
- “[I]f we need to page a wardsperson to transfer a patient to another ward or discharge a patient, it is all time consuming. They have the wards there going around [and they are] trying to give support, and we are trying to call them away to come do work for us so we can continue.”¹⁷⁵
- 11.103 A nurse unit manager at Hornsby Hospital told me that the lack of availability of cleaners also presents particular problems out-of-hours.¹⁷⁶ She said that this too can delay the transfer of patients to wards within the hospital:
- “[T]here is a problem with just simple things like cleaning out of hours, that support.
- The beds from the emergency department, we share beds, so if a patient is in a bed in emergency, they can wheel that bed into our unit and take one of our clean ones – we’ve done that to save a little bit of time, but there’s a lot of bed shuffling that goes on, because we’ve got five single rooms and two double rooms. If you have a patient come in that needs isolation, and you don’t have an isolation [room], you might have to move a patient from room 3 down to the double room, and we are forever swapping beds. We try and have patients with similar ages, we try and cohort them, so we’re moving beds for that reason as well.”¹⁷⁷
- 11.104 I was told that during the night at Wollongong Hospital there is only one cleaner for the entire hospital.¹⁷⁸ If nurses do not have time to do a thorough clean, the cleaning does not get done:

"Floors are left unmopped, mattresses [are] cleaned only on one side, bed rails and bases untouched, equipment hastily wiped if at all."¹⁷⁹

- 11.105 A midwife at Royal Prince Alfred Hospital told me that there was a lack of ancillary staff, such as ward assistants, to undertake jobs such as cleaning and making beds, and emptying linen bags, which are left for nurses to do.¹⁸⁰ She said that after-hours and on weekends, such staff are not employed; however, having people in those positions could reduce stress on nurses and (in particular) midwives, as midwifery is a 24-hour job.¹⁸¹ In this context, she stated:

"We are discharging patients sometimes at 8 or 9 o'clock at night. We need to clean the bathrooms, clean toilets, and [wash] and [make] beds instead of spending patient time. There really needs to be a role that is looked at, employing as a permanent role 24/7 in maternity, and I think it would reduce a lot of the stress."¹⁸²

- 11.106 The Acting Staff Manager of Staff Education at St George Hospital suggested that in the interests of staff morale, a cleaner should be allocated to every ward:

"If you had a cleaner allocated to your ward it would improve the overall cleanliness of the hospital, they would attend to spillages immediately, and arrange laundry of curtains which have a lot of dust and dirt on them. Once again, they would take pride in the look of the place, which is better for the patients, better for the environment, as well as the OH&S and infection control issues."¹⁸³

- 11.107 The following table shows the number of wardspersons and hospital assistants (cleaners) employed in NSW public hospitals as at June 2008:¹⁸⁴

Wardspersons and Hospital assistants employed in NSW Health, June 2008 full time equivalent and instances on payroll

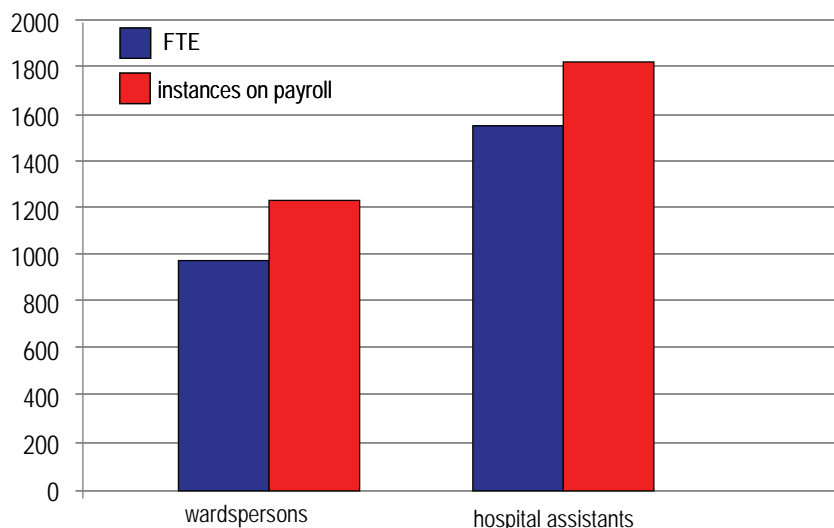

Source: DOH Health Information Exchange (HIE)

Note: There is no one award =code which accurately identifies wardspersons or cleaners and these staff are paid under many award categories, however the Hospital Assistant Grade accounts for almost 95% of cleaning staff within NSW Health. The figures for coding these staff rely on ANZSCO coding and this has not yet been fully implemented across all Area health Services.

The figures for hospital assistants reflects cleaning staff paid under this awards code and would include codes for commercial cleaners, domestic cleaners, domestic housekeepers and other cleaners not

already classified. Some cleaners are paid under contractual arrangements, which mean they would not appear in this data.

Figures prior to June 2008 are unable to be provided due to ANZSCO coding processes across NSW Health being incomplete in 2007.

- 11.108 On the basis of the evidence provided to the Inquiry, it is clear that the current levels of wardsperson and hospital assistant staffing in many wards are inadequate. This needs to be addressed as soon as possible. In Chapter 18 (Hospital Acquired Infection) I have recommended that there be a review of hospital cleaning services. I also propose to make a recommendation that there be a review of the current numbers of wardspersons so as to ensure their availability on the wards of our public hospitals.

Recommendation 40: *Within 12 months, NSW Health should create a position called clinical support officer within public hospitals in NSW to be filled on a needs and activity basis to undertake roles presently fulfilled by senior and junior clinical staff which can be undertaken by less, but nevertheless suitably, qualified or experienced individuals. The position will include being rostered for after hours work and on a 24 hour a day 7 days a week basis where the need is identified and where the ward activity requires, and would encompass those roles previously performed by communications clerks, ward clerks and wardsmen.*

Rostering

- 11.109 Put simply, the vast majority of health professionals (except for nurses engaged in clinical practice) work in NSW public hospitals from Monday to Friday each week during business hours, whilst patients get sick, have accidents, need care, arrive, are treated and discharged 24 hours a day across all 7 days of the week. Even after being admitted, some patients will deteriorate and perhaps die at any time of the day or night and whether it is a week day or a weekend or not. This apparently obvious proposition does not seem to be reflected in the current rostering practices of health professionals.
- 11.110 NSW Health gave me information which indicated that patient activity and medical workload after hours and on weekends in the five year period between 2002/03 and 2007/08 has grown by approximately 14% with approximately 40% of admissions occurring after hours in 2007/08.¹⁸⁵
- 11.111 The junior segment of the medical staff, i.e. interns, resident and registrars, have traditionally been rostered for the working week, during the day shift only and from Monday to Friday. A typical roster is for an 8 hour day on each day from Monday to Friday from 8.00 am to 4.30 pm with a half hour meal break. Starting and finishing times may vary. This covers a 40 hour week with the staff member taking a rostered day off on one day during the month.
- 11.112 The history of this is uncertain but seems to relate more to the educational requirements of the training programs of registrars. For example, the Royal Australasian College of Surgeons, in clauses 2.1.3 & 2.1.4 of the Regulations for the Surgical Education and Training Program in General Surgery, seems to prohibit general surgery trainees in their first training year from undertaking any more than 4 weeks on a night roster in each 6 month term and for trainees in subsequent years unable to do more than 2 weeks on a night roster in each 6 month term. The assumption lying behind the restriction seems to be that the learning environment is better during the day, and that one does not need to

learn surgery where it has to be done after usual business day hours. However, there is no need to express a concluded view. I will examine the effects of such rostering policy.

- 11.113 I should also say that the issue of reduced staffing also applies to allied health practitioners but not to as nearly a great extent to nurses undertaking clinical work (although it does seem to apply to some parts of the nursing workforce such as clinical nurse educators).

Safety issues

- 11.114 The notion that staffing a hospital, particularly with medical staff rosters as a day time business week facility means that patients who require medical attention after-hours are at a far greater risk of an adverse outcome. Indeed, many clinicians were of the view that present rostering practices are unsatisfactory.

- 11.115 The Acting Director of Nursing and Midwifery at Royal North Shore Hospital made the following comments in relation to the "9-to-5" service run by public hospitals:

"Night duty is the same as the afternoon shift. We seem to run a service that caters to patients Monday to Friday, 9-to-5; yet the patients are here 24 hours a day and the nurses are here 24 hours a day, but they don't have any support after hours. There [are] minimal medical staff [on the wards]. There is practically no allied health support after hours and on weekends."¹⁸⁶

- 11.116 A career medical officer at Mt Druiitt Hospital observed that because the demand on the Emergency Department is unpredictable, staffing needs to be adequate to cope with the busiest times.¹⁸⁷ He said that certain patterns are well established: for instance, winter is busier than summer, especially for breathing problems, and most childhood fractures and lacerations occur in the evening, on weekends and during school holidays.¹⁸⁸ He observed that despite this, general staffing levels and the number of senior staff in the Emergency Department units are greatest during weekday business hours.¹⁸⁹

- 11.117 The Director of Medical Services at The Tweed Hospital told me that the medical award generally ties doctors to a 9-to-5 structure, in circumstances where medical services are generally delivered from 7.00 am to 10.00 pm, 7 days a week.¹⁹⁰ He informed me that the number of doctors in the hospital drops from around 100 at 2.00 pm, to 15 at 6.00 pm,¹⁹¹ and stated:

"[P]eople have very short lengths of stay, they've got critical problems and the way industrially these jobs are structured does not easily allow for us to move into a shift paradigm from a medical point of view, as opposed to a Monday to Friday paradigm."¹⁹²

- 11.118 One doctor at Westmead Hospital raised the following concerns in relation to the lack of availability of senior medical personnel:

"Certainly, when I was an intern ... I was the senior person in the emergency department as an RMO 1, as a second-year out. People would be appalled if that was the situation at the moment. However, in the year 2008, in a lot of hospitals, the most senior person is someone who is 2 or 3 years out in telephone communication perhaps with someone senior, but that is the current situation in 2008. Obviously certain parts of the hospital like the ED have evolved in regard to increased coverage and increased senior coverage, but we will always be hampered by a lack of progress or evolution at the back end of the hospital."¹⁹³

- 11.119 The Executive Manager of the NSW Institute of Trauma and Injury Management told me that out-of-hours in most of the major teaching hospitals, the most junior surgical staff are rostered on, and are required to look after the most seriously injured people (who are most vulnerable in the middle of the night).¹⁹⁴ She told me that this causes an increase in both error and complication rates, and can also increase delay in the provision of appropriate care.¹⁹⁵
- 11.120 A midwife at Royal Prince Alfred Hospital told me that there are not enough senior medical staff available after-hours, and on public holidays and weekends.¹⁹⁶ She said that one registrar and one junior doctor provided coverage during those times to the labour ward, birth centre, antenatal unit, high dependency unit, 60-bed post-natal ward, and 30-bed gynaecology ward.¹⁹⁷ She stated that this is "far too great", noting that the registrar and resident may sometimes be in theatre doing an emergency caesarean section, leaving no one to cover the wards.¹⁹⁸
- 11.121 A nurse at The Tweed Hospital told me that during the evening shift, the nurses make a list of the jobs to be done by the surgical resident when he or she comes to the ward.¹⁹⁹ However, often the resident does not get to the ward until late at night and cannot attend to those jobs: they are then handed over to the night doctor who, in turn, might not come to the ward.²⁰⁰ She told me that if the nurses are concerned about a patient, they may then need to ask a doctor from the Emergency Department to come to the ward, taking the emergency doctor away from his or her work.²⁰¹
- 11.122 A nurse at Nepean Hospital told me that nursing staff have to pick up additional duties for medical staff after-hours, because there are not enough junior medical officers and they are not adequately trained.²⁰²
- 11.123 A registered nurse in the surgical ward at Coffs Harbour Base Hospital said that during the evenings and nights, patients return from theatre when there is less staff.²⁰³ In this context, she made the following observations:
- "You're going from a full team of medical back-up nursing unit managers, float nurses, to an in-charge person which I often am by myself or a 48-bed unit with some critically ill people in high dependency who can't get a bed in ICU and an intern or a junior medical officer trying to manage that situation. Often they don't have the back-up of their peers and we've got to try and muddle through that by ourselves."²⁰⁴
- 11.124 A registrar at Westmead Hospital told me that from 7am to 7pm, the hospital's acute surgical team consists of a consultant surgeon, an advanced trained general surgical registrar, a junior surgical registrar and a resident medical officer.²⁰⁵ After 7.00 pm, however, there is one general surgical registrar at the hospital.²⁰⁶ He or she is responsible for emergency consultations, ward consultations, and looking after the high dependency units.²⁰⁷ The witness told me that although there are several resident medical officers covering the surgical patients, and one resident medical officer for each of the high dependency units, some of those resident medical officers providing coverage to surgical wards may not be surgical residents nor be familiar with the patients.²⁰⁸ He proffered the following solution:

"Particularly after hours, I think there's a quite simple solution because the main problem is, as a general medical registrar, at times it is not uncommon that your care of patients is compromised or delayed because we may be operating and there are emergency patients who need to be assessed, but you can't be in two places at once. The simple fact of the matter is to have another person on after hours.

... I think that provides the best sort of service to the community and to the patients. However, I think as a simple solution, even a junior level registrar, along with an advanced trainee, can help, just an extra pair of hands, and all that would require is an extra 8 positions for the year to provide after hours covers, purely after hours cover."²⁰⁹

11.125 The witness told me that this solution would involve an increase of approximately 50% in surgical trainee numbers.²¹⁰ I do not know whether this estimate is correct or not, and whether it would apply more broadly than the hospital at which the witness was working. Whether any increase is necessary will need to be judged on a hospital by hospital basis, and also be considered only when a reorganisation of the rosters occurs. It may be that a more appropriate way of organising the roster would result in a better spread of the workforce across a longer period of the day, rather than a simple increase in the size of the workforce. But this is a matter of detail for careful consideration by others in due course.

11.126 The Director of Critical Care at Dubbo Base Hospital highlighted the absurdity of the current arrangements with respect to medical staff:

"What we do, we say we work Monday to Friday, it is bizarre, and then Saturday and Sunday we have a few junior staff to sort of pop in on (the patients). My belief is that every patient should be seen by a doctor every day that they are in hospital. The hospital is a valuable resource, we shouldn't be just leaving them in there."²¹¹

11.127 An older man, who was a patient at Orange Base Hospital, told me that during his recent stay there, the cannula delivering his antibiotics fell out during the night. There was only one doctor available to cover the hospital during the night and it took 4 hours for him to attend the patient and remedy the situation.²¹² The witness said:

"In a place the size of Orange I feel this situation is very dangerous."²¹³

11.128 The sister of a patient who was struck by a car and died after being admitted to the Emergency Department at St George Hospital drew my attention to the findings of the Root Cause Analysis, which noted that on the relevant morning there was an inadequate number of staff to deal with patients, including no senior consultant/designated medical leader rostered on duty in the Emergency Department between midnight and 8.00 am.²¹⁴ In circumstances, where the post-mortem report found evidence of terminal medical intervention, the patient's sister stated:

"Why is it that there [was] no senior consultant/designated medical leader rostered between those hours? This may have resulted in a different outcome for Matthew. This decision not to roster is putting the lives of other people at risk and needs to be changed."²¹⁵

11.129 I agree. It is clear, beyond rational debate, that a lack of round-the-clock senior medical coverage is unsafe and can have devastating adverse consequences for patient care.

Access block

11.130 Quite apart from the obvious safety concerns, the lack of medical staff on the wards can lead to access block, for, at least, 2 reasons.

- 11.131 Firstly, clinicians working in the Emergency Department after-hours cannot safely transfer a patient to a ward if there is a lack of medical and nursing staff on the ward.
- 11.132 To illustrate, a doctor at Westmead Hospital told me that the Emergency Department is staffed with a senior clinician 16 hours a day, 7 days a week.²¹⁶ At the “back end” of the hospital, however, the wards are only staffed by senior clinicians from 9.00 am to 5.00 pm.²¹⁷ The witness observed:
- “[U]nless there is a proper back-end that is well staffed and supervised, you cannot send patients to the wards if you have any degree of concern regarding their ongoing safety over the next 24 hours.”²¹⁸
- 11.133 The witness told me that the hospital is thus faced with a situation of empty beds on the wards, with “patients in corridors” having no access to those beds because safe outcomes on the wards cannot be guaranteed due to inadequate rostering of junior medical officers.²¹⁹
- 11.134 The Director of the Emergency Department at Liverpool Hospital likewise submitted that one of the causes of access block is inadequate staffing of inpatient medical units, which have 90% of their staff rostered on-site Monday to Friday 9.00 am to 5.00 pm, with the other 10% being spread across the weekends and nights (when most of the admissions occur).²²⁰ He suggested that staffing levels in these units be re-distributed more proportionately across 24 hours to redress the imbalance between acute admissions and inpatient medical staff coverage in the evenings.²²¹
- 11.135 A staff specialist in the Emergency Department at Westmead Hospital told me that they find that there are problems in that unit because of a lack of a 24 hour a day 7 day a week model of care.²²² She said that things may work well during the day, but there are shortcomings during the night.²²³ She provided the following example:
- “A lot of the new things that have been introduced to allow patients to be transferred to the ward quickly can only exist and show their benefit in the working hours. Of course, there are 168 hours in the week and that takes up only 38 hours in the week.”²²⁴
- 11.136 The second reason a lack of medical staff can lead to access block is because patients who are ready to be discharged home after-hours or on the weekend - for example, a mother and her newborn baby - often are being treated, and cannot be discharged, on the basis that the model of care requires that they must be seen by a doctor to authorise the discharge.
- 11.137 For example, a nurse at Wollongong Hospital told me that on weekends and public holidays, that hospital only has one paediatric registrar.²²⁵ When women are ready to be discharged from the post-natal ward with their well babies, the paediatric registrar needs to check the baby and complete the baby’s health record.²²⁶ That doctor is also responsible for the Emergency Department, the children’s ward, attending caesarean sections within the hospital, attending the birth unit (where there might be a distressed baby who is about to be born), and dealing with the neo-natal unit.²²⁷ The witness told me that there could be a number of demands on that doctor’s time, and that checking a healthy baby prior to it going home is “way down” on the list of priorities.²²⁸ As a consequence, bed block may arise when up to 7 women would like to leave hospital on either a Saturday, Sunday or public holiday.²²⁹
- 11.138 There are a number of impediments to rostering more clinicians after hours.

Safe and congenial working hours

- 11.139 A visiting medical officer at Royal North Shore Hospital told me that the best education of clinicians and the best patient care occurs between 7.30 am and 4.30 pm, in terms of bringing together good doctors, good registrars, “appropriate patients”, a good teaching environment and mentoring time.²³⁰ He nevertheless observed that 50% of cases are attended to after-hours and on weekends.²³¹ He also told me that any other arrangement is disruptive to employees’ lifestyle, and it is safer to work from 7.30 am to 5.00 pm, when staff will commit themselves to “working quickly, working well”.²³²
- 11.140 He was not the only senior clinician to express sentiments of this kind to me. These sentiments seem to combine three elements about working in business hours: first, that it provides the best teaching and learning opportunities, secondly, another arrangement is unsatisfactory from a work/life balance perspective and thirdly that business hours are safer, presumably because of a lack of fatigue and a greater critical mass of staff available to treat patients.
- 11.141 Each of these propositions may be true as they relate to the much of the present operations of public hospitals. Of course there are many clinicians, in areas such as Emergency Departments and Intensive Care Units, who do work a full 24 hour a day 7 day a week roster.
- 11.142 Let me deal with each of the propositions in turn. The proposition of “safe working hours” is one which focuses on fatigue. It involves the notion that staff should not work too long in one shift, and that certain sequences of shifts promote exhaustion and therefore need to be avoided. Whilst I accept that this is so, the reality is that the needs of patients arise and have to be dealt with safely and effectively on a 24 hour a day, 7 day a week basis. I do not consider that there is any necessary inconsistency between the notion of safe working hours and having a hospital staffed adequately on a 24 hour a day basis, provided that careful planning and rostering is undertaken. There are many professions and industries which operate entirely successfully on a 24 hour a day and 7 day a week basis. Systems are available to adequately cater for fatigue in those environments. There is no reason in principle that public hospitals should be any different.
- 11.143 The proposition that the best teaching and learning opportunities during business hours is on careful examination a somewhat circular one. The best teaching and learning opportunities occur when those engaged in teaching and learning are present in good numbers, are not fatigued and are able to have access to a full range of patients and their conditions. With different rostering practices, the critical mass of appropriate senior staff would be available and teaching could well take place. The patients are also present 24 hours a day. True it is that one cannot expect interaction with a patient to be appropriate for the whole of a 24 hour day, but this does not mean that teaching and learning cannot be useful or appropriate.
- 11.144 I am left with what seems to be the real stumbling block, namely work/life balance. I am very conscious of the importance of this fact. Many clinicians have family responsibilities, which make it difficult to work after-hours and on weekends. I accept that this is so, as it is for many other professions and organisations. Certainly, a nurse unit manager at Hornsby Hospital told me that it is hard to get registered nurses with families to work night shifts.²³³
- 11.145 NSW Health told me that 92% of NSW nurses are women, a large proportion of whom will have responsibilities beyond the workplace.²³⁴ The NSW Nurses’ Association submitted that working shifts is one of the biggest disincentives to a clinical nursing or

midwifery career, and that there needs to be greater flexibility in rostering patterns if nurses are to be retained.²³⁵

11.146 Similarly, the Council of NSW Area Directors of Allied Health drew my attention to the fact that with a relatively high proportion of females across allied health, there is a need for more flexible work arrangements.²³⁶

11.147 I also heard evidence that newer medical and nursing graduates are placing greater emphasis on lifestyle, which is presenting greater challenges in filling rosters, particularly those after hours. The Institute of Medical Education and Training told me that the new generation of doctors thinks very differently about work/life balance than did previous generations.²³⁷ It was submitted that this attitude would require reform of work practices.

11.148 Whilst I accept that the needs and wishes of staff about a work/life balance are real and relevant, if one accepts as I do, that the central mission and core purpose of the provision of public hospital care is to put the patient at the centre of the health system and ask how the best, safest and most effective patient care can be achieved, then the primacy of that purpose suggests that the work/life balance issue of the clinicians whilst it cannot be ignored, cannot dictate the way in which patient care is delivered in public hospitals in NSW. Whilst I acknowledge and do not underestimate the immense contribution of the health workforce to our public hospitals, it seems to me that on this topic, the balance has shifted too far in favour of staff over patients, particularly in respect of senior doctors and a new balance needs to be struck. For the future, I am firmly convinced that the current rostering practices must be changed.

The way forward

11.149 Nursing staff are generally used to the idea that they are required to care for patients on a 24 hour a day 7 day a week basis, albeit that the number of nurses may be somewhat less after hours. The real problem from all of the evidence appears to be with the numbers of medical staff, particularly senior medical staff, who are rostered on duty after hours. As I have said, the notion that a hospital only requires a full complement of medical staff from 9.00 am to 5.00 pm is inconsistent, in my view, with meeting the needs of patients. There needs to be a real shift in thinking from the present 9.00 am to 5.00 pm model to an acceptance of a 24 hour a day, 7 day a week model of care.

11.150 There is no reason to think that future rostering on the basis of a 24 hour a day, 7 day a week model of care cannot be done in a way which has regard to and deals with the concerns of patient care, flexibility of rostering arrangements, work/life balance and fairness in the sharing of shifts.

11.151 The NSW Nurses' Association drew my attention to a range of automated rostering systems – such as E-rostering commonly used in the National Health Service in the United Kingdom – which endeavour to strike an appropriate balance between maintaining adequate skill mix in the interests of quality patient care as against a reasonable work-life balance.²³⁸ I was told that the key difference between the systems implemented in various parts of the National Health Service and other automated systems is that the National Health Service has incorporated work-life balance for staff as a key objective to its rostering practices, and its automated systems therefore have the capacity to accommodate team-based self-rostering.²³⁹

11.152 Although alterations in the rostering of clinical staff would appear to members of the public to be simple common sense, it may be perceived by clinicians, particularly the medical profession as a radical change. I note that the implementation of any new

rostering model can only succeed with the cooperation of those affected by it. I would sincerely hope that this is one area of necessary reform that is not dominated by self interest, but that all involved put the interests of patient care at the forefront of planning and redesign.

Recommendation 41: *NSW Health, within 6 months, is to implement a project, the aim of which is to redesign rostering systems and practice for senior and junior doctors and senior nurses in a way which promotes safety and good quality patient care. The aim of the project must be:*

- (a) *To ensure the presence of an appropriate number and range of skills of these clinicians in all hospitals down to and including Peer Hospital Group Category C1 for 16 hours a day;*
- (b) *To ensure the availability of the services of these clinicians for 7 days per week; and*
- (c) *To ensure adequate coverage, whether by an on-call service or otherwise for the remaining 8 hour shift for each day.*

Nightshift culture

- 11.153 Finally, before leaving this topic, I heard evidence that some nurses prefer working night shift but develop a particular culture which is not necessarily conducive to patient care.
- 11.154 Indeed, one witness told me that her experience is that night shift staff tend to be largely the same people who are “permanent” on night shift.²⁴⁰ They do not usually work day shift.²⁴¹ She told me that the after-hours staff tend to choose night shift because it attracts penalty rates, and because it suits their family circumstances.²⁴² She said that night shift workers do not have as much exposure to the day-to-day things: they do not see the team doctors as often, they do not have the opportunity to meet with management and see what is happening on the wards, nor do they see what new in-services are available.²⁴³
- 11.155 In the witness’ view, night shift workers do not have access to education, partly because if a person works during the night, courses are difficult to get to.²⁴⁴ She told me that her perception, based on experience, is that some permanent night shift nurses aim simply to get through their shift without anything going wrong, and then hand over any problems to the next shift.²⁴⁵
- 11.156 It was suggested to me that every nurse on permanent night or after-hours shifts should spend at least one month of every year rotated through the day shifts to become familiar with current procedures, and to enable managers to check their level of competence.²⁴⁶ It was suggested that this would assist nurses to recognise deteriorating patients and take early action.²⁴⁷
- 11.157 I accept that there is in many public hospitals around the state a similar perception to that which I have just described. Whether it is the reality is probably impossible, at present, to determine. I do think however that the proper care of patients requires that all nursing staff, whenever they work, be adequately competent and have available sufficient training, performance and skill assessment. To achieve this aim, for example, it may be a comparatively simple matter to roster clinical nurse educators during evening and night shifts. Another way of achieving the same result might be to adopt the suggestion to which I have referred above about requiring everyone to be rotated through a minimum number of day shifts in each year. In undertaking the project about

which I have just made a recommendation, it will be appropriate to keep these matters in mind.

-
- ¹ NSW Health Briefing, 21 April 2008, transcript 24.5-10.
 - ² Letter from NSW Health to Special Commission of Inquiry, 6 November 2008.
 - ³ Submission of Dr Andrew Hooper, 30 March 2008, SUBM.008.0017 at 19.
 - ⁴ Submission of Westmead Medical Staff Council, undated, SUBM.013.0089 at 97.
 - ⁵ Submission of Westmead Medical Staff Council, undated, SUBM.013.0089 at 97.
 - ⁶ Submission of Westmead Medical Staff Council, undated, SUBM.013.0089 at 97.
 - ⁷ Meeting with Institute of Medical Education and Training, 3 April 2008, transcript 77.6-16.
 - ⁸ Dr Michael Brydon, Sydney Children's Hospital hearing, 19 May 2008, transcript 3047.45-3048.9.
 - ⁹ Meeting with representatives of the AMA (NSW) and ASMOF, 23 June 2008.
 - ¹⁰ Meeting with representatives of the AMA (NSW) and ASMOF, 23 June 2008; Workplace Research Centre, University of Sydney, *Working Conditions of Doctors and Nurses in NSW Public Hospitals – Survey for Submission to Garling Inquiry*, 20 March 2008 (Appendix A to submission of AMA (NSW) and ASMOF, 28 March 2008, SUBM.016.0015).
 - ¹¹ Submission of AMA (NSW) and ASMOF, 28 March 2008, SUBM.016.0015 at 20.
 - ¹² Submission of AMA (NSW) and ASMOF, 28 March 2008, SUBM.016.0015 at 20.
 - ¹³ Submission of AMA (NSW) and ASMOF, 28 March 2008, SUBM.016.0015 at 21.
 - ¹⁴ Confidential Armidale hearing, 26 March 2008, transcript 17.18-31.
 - ¹⁵ Submission of NSW Nurses' Association, March 2008, SUBM.042.0335 at 368.
 - ¹⁶ Submission of NSW Nurses' Association, March 2008, SUBM. 042.0335 at 351.
 - ¹⁷ Workplace Research Centre, University of Sydney, *Working Conditions of Doctors and Nurses in NSW Public Hospitals – Survey for Submission to Garling Inquiry*, 20 March 2008, pp. 12-13 (Appendix A to submission of AMA (NSW) and ASMOF, 28 March 2008, SUBM.016.0015).
 - ¹⁸ Helen Harwood, Mudgee hearing, 20 March 2008, transcript 715.37-43.
 - ¹⁹ Information provided during visit to Mona Vale Hospital on 12 March 2008.
 - ²⁰ Information provided during visit to Royal Prince Alfred Hospital on 14 February 2008.
 - ²¹ Confidential hearing at Inquiry's offices via video-link from Wagga Wagga, 30 May 2008, transcript 16.19-22.
 - ²² Confidential hearing at Inquiry's offices via video-link from Wagga Wagga, 30 May 2008, transcript 16.22-32.
 - ²³ Confidential Wagga Wagga hearing, 22 April 2008, transcript 9.34-45.
 - ²⁴ Confidential hearing at the Inquiry's offices via video-link from Tweed Heads, 29 May 2008, transcript 9.31-34.
 - ²⁵ Confidential hearing at the Inquiry's offices via video-link from Tweed Heads, 29 May 2008, transcript 9.35-38.
 - ²⁶ Confidential hearing at the Inquiry's offices via video-link from Tweed Heads, 29 May 2008, transcript 9.38-40.
 - ²⁷ Confidential Wollongong hearing, 14 April 2008, transcript 47.18-21.
 - ²⁸ Confidential Wollongong hearing, 14 April 2008, transcript 47.25-30.
 - ²⁹ Confidential Wollongong hearing, 14 April 2008, transcript 47.30-32.
 - ³⁰ Confidential Wollongong hearing, 14 April 2008, transcript 50.26-31.
 - ³¹ Confidential Wollongong hearing, 14 April 2008, transcript 50.33-34.
 - ³² Meeting with Professor Clifford Hughes, Clinical Excellence Commission, 12 February 2008.

-
- ³³ Meeting with Dr Helen Bevan, National Health Service (United Kingdom), 14 March 2008; National Health Service Institute for Innovation and Improvement, *The Productive Ward: Outline of Project*, August 2006, National Health Service, p. 1.
- ³⁴ National Health Service Institute for Innovation and Improvement, *The Productive Ward: Outline of Project*, August 2006, National Health Service, p. 1.
- ³⁵ Meeting with Dr Helen Bevan, National Health Service (United Kingdom), 14 March 2008; National Health Service Institute for Innovation and Improvement website, *The productive ward module structure*, http://www.institute.nhs.uk/quality_and_value/productivity_series/the_productive_ward_module_structure.html (23 November 2008).
- ³⁶ Meeting with Dr Helen Bevan, National Health Service (United Kingdom), 14 March 2008; National Health Service Institute for Innovation and Improvement website, *The productive ward module structure*, http://www.institute.nhs.uk/quality_and_value/productivity_series/the_productive_ward_module_structure.html (23 November 2008).
- ³⁷ Meeting with Dr Helen Bevan, National Health Service (United Kingdom), 14 March 2008; National Health Service Institute for Innovation and Improvement website, *The productive ward module structure*, http://www.institute.nhs.uk/quality_and_value/productivity_series/the_productive_ward_module_structure.html (23 November 2008).
- ³⁸ Meeting with Dr Helen Bevan, National Health Service (United Kingdom), 14 March 2008; National Health Service Institute for Innovation and Improvement website, *The productive ward module structure*, http://www.institute.nhs.uk/quality_and_value/productivity_series/the_productive_ward_module_structure.html (23 November 2008).
- ³⁹ Meeting with Dr Helen Bevan, National Health Service (United Kingdom), 14 March 2008.
- ⁴⁰ Meeting with Dr Helen Bevan, National Health Service (United Kingdom), 14 March 2008.
- ⁴¹ Meeting with Dr Helen Bevan, National Health Service (United Kingdom), 14 March 2008.
- ⁴² NSW Health Briefing, 2 September 2008, transcript 27.45-28.5.
- ⁴³ NSW Health Briefing, 2 September 2008, transcript 28.30-31.
- ⁴⁴ NSW Health Briefing, 2 September 2008, transcript 28.37-43.
- ⁴⁵ NSW Health Briefing, 2 September 2008, transcript 28.44-45.
- ⁴⁶ NSW Health Briefing, 2 September 2008, transcript 28.45-29.2.
- ⁴⁷ NSW Health Briefing, 2 September 2008, transcript 29.9.
- ⁴⁸ NSW Health Briefing, 2 September 2008, transcript 29.18-25.
- ⁴⁹ NSW Health Briefing, 2 September 2008, transcript 29.38-44.
- ⁵⁰ NSW Health Briefing, 2 September 2008, transcript 31.33-43.
- ⁵¹ NSW Health Briefing, 2 September 2008, transcript 32.27-28.
- ⁵² NSW Health Briefing, 2 September 2008, transcript 49.37-43.
- ⁵³ NSW Health Briefing, 2 September 2008, transcript 26.42-43 and 43.1-11.
- ⁵⁴ See the evidence of Julia Batty, Sydney Children's Hospital hearing, 19 May 2008, transcript 2999.25-31.
- ⁵⁵ Submission of Graeme Kershaw, North West Slopes Division of General Practice, 28 March 2008, SUBM.009.0230 at 231.
- ⁵⁶ Dr Susan Hodgkinson, Liverpool hearing, 17 April 2008, transcript 1861.4-5.
- ⁵⁷ Dr Susan Hodgkinson, Liverpool hearing, 17 April 2008, transcript 1860.15-32.
- ⁵⁸ Dr Susan Hodgkinson, Liverpool hearing, 17 April 2008, transcript 1860.34-38.
- ⁵⁹ Dr Susan Hodgkinson, Liverpool hearing, 17 April 2008, transcript 1860.38-39.
- ⁶⁰ Dr Susan Hodgkinson, Liverpool hearing, 17 April 2008, transcript 1860.38-40.
- ⁶¹ Dr Thomas Karplus, Concord hearing, 24 April 2008, transcript 2110.43-46.
- ⁶² Dr Thomas Karplus, Concord hearing, 24 April 2008, transcript 2110.46-2111.6.

-
- ⁶³ Dr Judith Trotman, Concord hearing, 24 April 2008, transcript 2192.22-26.
- ⁶⁴ Dr Judith Trotman, Concord hearing, 24 April 2008, transcript 2192.28-44.
- ⁶⁵ Letter from NSW Health to Special Commission of Inquiry, 4 September 2008.
- ⁶⁶ NSW Health Briefing, 21 April 2008, transcript 22.45-23.2.
- ⁶⁷ NSW Health Briefing, 21 April 2008, transcript 30.3-6; NSW Health Presentation to Special Commission of Inquiry: *Cutting Red Tape*, 21 April 2008, p. 5.
- ⁶⁸ NSW Health Briefing, 21 April 2008, transcript 30.3-6; NSW Health Presentation to Special Commission of Inquiry: *Cutting Red Tape*, 21 April 2008, p. 5.
- ⁶⁹ NSW Health Briefing, 21 April 2008, transcript 30.3-6; NSW Health Presentation to Special Commission of Inquiry: *Cutting Red Tape*, 21 April 2008, p. 5.
- ⁷⁰ Information provided during visit to Concord Repatriation General Hospital on 21 February 2008.
- ⁷¹ Confidential Bankstown hearing, 13 May 2008, transcript 12.47-13.2.
- ⁷² Confidential Bankstown hearing, 13 May 2008, transcript 13.2-5.
- ⁷³ Confidential submission, 28 April 2008, SUBM.039.0009 at 12.
- ⁷⁴ Confidential submission, 28 April 2008, SUBM.039.0009 at 12.
- ⁷⁵ Dr Louis Christie, Orange hearing, 18 March 2008, transcript 542.47-543.9.
- ⁷⁶ Dr Thomas Karplus, Concord hearing, 24 April 2008, transcript 2106.31-35.
- ⁷⁷ Dr Thomas Karplus, Concord hearing, 24 April 2008, transcript 2106.37-42.
- ⁷⁸ Dr Thomas Karplus, Concord hearing, 24 April 2008, transcript 2106.43-45.
- ⁷⁹ Dr Thomas Karplus, Concord hearing, 24 April 2008, transcript 2106.45-2107.1.
- ⁸⁰ Confidential Royal North Shore Hospital hearing, 2 April 2008, transcript 7.17-42.
- ⁸¹ Maree Nott, Mudgee hearing, 20 March 2008, transcript 742.43-45.
- ⁸² Maree Nott, Mudgee hearing, 20 March 2008, transcript 742.34-36.
- ⁸³ Maree Nott, Mudgee hearing, 20 March 2008, transcript 742.45-743.1.
- ⁸⁴ Information provided during visit to Liverpool Hospital on 26 February 2008.
- ⁸⁵ Confidential Bankstown hearing, 13 May 2008, transcript 64.40-41.
- ⁸⁶ Confidential Bankstown hearing, 13 May 2008, transcript 64.41-42.
- ⁸⁷ Dr Charles Lawrie, Hornsby hearing, 11 March 2008, transcript 231.18-34.
- ⁸⁸ Rosalyn Ferguson, Hornsby hearing, 11 March 2008, transcript 232.35-233.9.
- ⁸⁹ Confidential submission, 28 March 2008, SUBM.014.0092 at 106.
- ⁹⁰ Dr Sally McCarthy, Prince of Wales Hospital hearing, 1 May 2008, transcript 2579.39-41.
- ⁹¹ Dr Sally McCarthy, Prince of Wales Hospital hearing, 1 May 2008, transcript 2579.43-45.
- ⁹² Dr Sally McCarthy, Prince of Wales Hospital hearing, 1 May 2008, transcript 2581.29-38.
- ⁹³ Dr Peter Roberts, Hornsby hearing, 11 March 2008, transcript 203.41-204.3.
- ⁹⁴ Information provided during visit to Royal Prince Alfred Hospital on 14 February 2008.
- ⁹⁵ Letter from NSW Health to Special Commission of Inquiry, 21 October 2008.
- ⁹⁶ Colera, E, Jayasuriya R, Hardy J, Bannan A, Thorper M, "Communication loads on clinical staff in the emergency department" (2002) 176 Medical Journal of Australia, 415-418.
- ⁹⁷ Submission of Dr Charles Lawrie, Dr Anne Clarke & Rosalyn Ferguson, undated, SUBM.010.0011 at 11; Submission of Dr Sue Ieraci and Dr Deniz Tek, March 2008, SUBM.009.0001 at 2; Information provided during visit to Liverpool Hospital on 26 February 2008.
- ⁹⁸ Letter from NSW Health to Special Commission of Inquiry, 21 October 2008.
- ⁹⁹ Letter from NSW Health to Special Commission of Inquiry, 21 October 2008.
- ¹⁰⁰ Submission of Dr Simon Battersby and Dr Bill Munro, Medical Staff Council of Wyong Hospital and Gosford Hospital respectively, March 2008, SUBM.002.0050 at 54.

-
- 101 Submission of Dr Simon Battersby and Dr Bill Munro, Medical Staff Council of Wyong Hospital and Gosford Hospital respectively, March 2008, SUBM.002.0050 at 54.
- 102 Submission of Dr Simon Battersby and Dr Bill Munro, Medical Staff Council of Wyong Hospital and Gosford Hospital respectively, March 2008, SUBM.002.0050 at 55.
- 103 Information provided during visit to Royal Prince Alfred Hospital on 14 February 2008.
- 104 Information provided during visit to Concord Repatriation General Hospital on 21 February 2008.
- 105 Information provided during visit to Concord Repatriation General Hospital on 21 February 2008.
- 106 Information provided during visit to St George Hospital on 21 February 2008.
- 107 Information provided during visit to St George Hospital on 21 February 2008.
- 108 Information provided during visit to Liverpool Hospital on 26 February 2008.
- 109 Information provided during visit to Liverpool Hospital on 26 February 2008.
- 110 Information provided during visit to St George Hospital on 21 February 2008.
- 111 Information provided during visit to Liverpool Hospital on 26 February 2008.
- 112 Information provided during visit to Liverpool Hospital on 26 February 2008.
- 113 Dr Peter Roberts, Hornsby hearing, 11 March 2008, transcript 205.31-43.
- 114 Submission of Dr Michael Golding on behalf of Sutherland Hospital Emergency Department Staff Specialists, SUBM.023.0202 at 207.
- 115 Submission of Dr Andrew Hooper, 30 March 2008, SUBM.008.0017 at 21.
- 116 Dr Gina Watkins, private Sydney Children's Hospital hearing, 19 May 2008.
- 117 Dr Gina Watkins, private Sydney Children's Hospital hearing, 19 May 2008.
- 118 Dr Gina Watkins, private Sydney Children's Hospital hearing, 19 May 2008.
- 119 Dr Dennis Pisk, Tweed Heads hearing, 29 April 2008, transcript 2413.27-31.
- 120 Confidential submission, 28 March 2008, SUBM.014.0092 at 102.
- 121 Information provided during visit to St George Hospital on 21 February 2008 and during visit to Liverpool Hospital on 26 February 2008.
- 122 Submission of Dr Sue Ieraci and Dr Deniz Tek, March 2008, SUBM.009.0001 at 2.
- 123 Submission of Dr Sue Ieraci and Dr Deniz Tek, March 2008, SUBM.009.0001 at 2 citing Morris J, Ieraci S, Bauman A, & Morhsin M, *Emergency Department Workpractice Review Project: Project Report*, May 2001, NSW Department of Health.
- 124 Morris J, Ieraci S, Bauman A, & Morhsin M, *Emergency Department Workpractice Review Project: Project Report*, May 2001, NSW Department of Health, SUBM.009.0012.
- 125 Morris J, Ieraci S, Bauman A, & Morhsin M, *Emergency Department Workpractice Review Project: Project Report*, May 2001, NSW Department of Health, SUBM.009.0012 at 0027 at 27.
- 126 Morris J, Ieraci S, Bauman A, & Morhsin M, *Emergency Department Workpractice Review Project: Project Report*, May 2001, NSW Department of Health, SUBM.009.0012 at 22.
- 127 Morris J, Ieraci S, Bauman A, & Morhsin M, *Emergency Department Workpractice Review Project: Project Report*, May 2001, NSW Department of Health, SUBM.009.0012 at 29.
- 128 Dr Rebecca Kozor, Hornsby hearing, 11 March 2008, transcript 178.6-31.
- 129 Dr Rebecca Kozor, Hornsby hearing, 11 March 2008, transcript 179.31-38.
- 130 Dr Rebecca Kozor, Hornsby hearing, 11 March 2008, transcript 178.36-179.2.
- 131 Dr Lisa Phipps, Westmead hearing, 10 April 2008, transcript 1494.40-44.
- 132 Dr Lisa Phipps, Westmead hearing, 10 April 2008, transcript 1494.44-1495.2.
- 133 Dr Lisa Phipps, Westmead hearing, 10 April 2008, transcript 1495.2-5.
- 134 Dr Lisa Phipps, Westmead hearing, 10 April 2008, transcript 1495.7-16.
- 135 Confidential Armidale hearing, 26 March 2008, transcript 17.47-19-6.
- 136 Rozlyn Norman, Tamworth hearing, 25 March 2008, transcript 801.31-32.

-
- 137 Rozlyn Norman, Tamworth hearing, 25 March 2008, transcript 801.33-35.
- 138 Rozlyn Norman, Tamworth hearing, 25 March 2008, transcript 801.38-802.18.
- 139 Letter from NSW Health to Special Commission of Inquiry, 4 September 2008.
- 140 Brian Grant, Liverpool hearing, 17 April 2008, transcript 1841.40-1842.07.
- 141 Karen Fernance, Bankstown hearing, 13 May 2008, transcript 2834.40-2835.17.
- 142 Confidential Wollongong hearing, 14 April 2008, transcript 42.41-44.
- 143 Confidential Wollongong hearing, 14 April 2008, transcript 43.2-3.
- 144 Confidential Wollongong hearing, 14 April 2008, transcript 43.3-5.
- 145 Confidential Wollongong hearing, 14 April 2008, transcript 43.5-6.
- 146 Lorraine Fitzgerald and Karen Fernance, Bankstown hearing, 13 May 2008, transcript 2832.37-45.
- 147 Jennifer Baroutis, Port Macquarie hearing, 28 March 2008, transcript 1098.42-1099.1.
- 148 Jennifer Baroutis, Port Macquarie hearing, 28 March 2008, transcript 1098.35-38.
- 149 Confidential Wollongong hearing, 14 April 2008, transcript 46.39-40 and 47.3-4.
- 150 Confidential Wollongong hearing, 14 April 2008, transcript 46.40-41.
- 151 Information provided during visit to Macksville Hospital on 27 March 2008.
- 152 Information provided during visit to The Children's Hospital at Westmead on 15 May 2008.
- 153 Wendy Smith, Liverpool hearing, 17 April 2008, transcript 1836.33-40.
- 154 Wendy Smith, Liverpool hearing, 17 April 2008, transcript 1836.44-1837.1.
- 155 Pamela Barrett, Tweed Heads hearing, 29 April 2008, transcript 2388.34-41.
- 156 Pamela Barrett, Tweed Heads hearing, 29 April 2008, transcript 2388.41-2399.4.
- 157 Pamela Barrett, Tweed Heads hearing, 29 April 2008, transcript 2399.5-6.
- 158 Jan Tweedie, Royal North Shore Hospital hearing, 14 March 2008, transcript 313.13.
- 159 Jan Tweedie, Royal North Shore Hospital hearing, 14 March 2008, transcript 313.35-39.
- 160 Jan Tweedie, Royal North Shore Hospital hearing, 14 March 2008, transcript 314.9-13.
- 161 Jennifer Kiddle, Mudgee hearing, 20 March 2008, transcript 737.13-14.
- 162 Jennifer Kiddle, Mudgee hearing, 20 March 2008, transcript 737.14-24.
- 163 Wendy Goodman, John Hunter Hospital hearing, 12 May 2008, transcript 2769.3-12.
- 164 Wendy Goodman, John Hunter Hospital hearing, 12 May 2008, transcript 2769.18-19.
- 165 Letter from NSW Health to Special Commission of Inquiry, 21 October 2008; NSW Health, *Wardsperson – Position Description*, Position No. 04175210018, NSW Health, p. 1.
- 166 Letter from NSW Health to Special Commission of Inquiry, 21 October 2008.
- 167 Letter from NSW Health to Special Commission of Inquiry, 21 October 2008; NSW Health, *Hospital Assistant Grade 2 (Cleaner) – Position Description*, Position No. 0407605A08, NSW Health, p. 1.
- 168 Letter from NSW Health to Special Commission of Inquiry, 21 October 2008.
- 169 Letter from NSW Health to Special Commission of Inquiry, 21 October 2008.
- 170 Letter from NSW Health to Special Commission of Inquiry, 21 October 2008.
- 171 Jan Tweedie, Royal North Shore Hospital hearing, 14 March 2008, transcript 312.44-47.
- 172 Jan Tweedie, Royal North Shore Hospital hearing, 14 March 2008, transcript 312.45-47.
- 173 Lorraine Fitzgerald, Bankstown hearing, 13 May 2008, transcript 2837.2-10.
- 174 Karen Fernance, Bankstown hearing, 13 May 2008, transcript 2837.12-31.
- 175 Lorraine Fitzgerald, Bankstown hearing, 13 May 2008, transcript 2835.40-45.
- 176 Debbie Skinner, Hornsby hearing, 11 March 2008, transcript 245.15-16 and 23-24.
- 177 Debbie Skinner, Hornsby hearing, 11 March 2008, transcript 245.23-36.
- 178 Confidential submission, 16 April 2008, SUBM.031.0059 at 73.

-
- 179 Confidential submission, 16 April 2008, SUBM.031.0059 at 73.
- 180 Confidential Royal Prince Alfred Hospital hearing, 20 May 2008, transcript 20.21-25.
- 181 Confidential Royal Prince Alfred Hospital hearing, 20 May 2008, transcript 20.25-28.
- 182 Confidential Royal Prince Alfred Hospital hearing, 20 May 2008, transcript 20.30-35.
- 183 Julie Gibbs, St George Hospital hearing, 14 May 2008, transcript 2860.21-28.
- 184 Letter from NSW Health to Special Commission of Inquiry, 21 October 2008.
- 185 Admitted patient data collection – 2002/2003 and 2007/2008 – NSW Health Information Exchange.
- 186 Jan Tweedie, Royal North Shore Hospital hearing, 14 March 2008, transcript 314.9-19.
- 187 Submission of Dr David Potter, 12 June 2008, SUBM.076.0388 at 398.
- 188 Submission of Dr David Potter, 12 June 2008, SUBM.076.0388 at 398.
- 189 Submission of Dr David Potter, 12 June 2008, SUBM.076.0388 at 398.
- 190 Dr Dennis Pisk, Tweed Heads hearing, 29 April 2008, transcript 2408.37-2409.4.
- 191 Dr Dennis Pisk, Tweed Heads hearing, 29 April 2008, transcript 2409.4-9.
- 192 Dr Dennis Pisk, Tweed Heads hearing, 29 April 2008, transcript 2409.9-14.
- 193 Confidential Westmead hearing, 26 May 2008, transcript 40.33-44.
- 194 Andrea Delprado, Liverpool hearing, 17 April 2008, transcript 1890.39-44.
- 195 Andrea Delprado, Liverpool hearing, 17 April 2008, transcript 1890.44-47.
- 196 Confidential Royal Prince Alfred Hospital hearing, 20 May 2008, transcript 20.37-40.
- 197 Confidential Royal Prince Alfred Hospital hearing, 20 May 2008, transcript 20.41-44.
- 198 Confidential Royal Prince Alfred Hospital hearing, 20 May 2008, transcript 20.44-47.
- 199 Alison Jux, Tweed Heads hearing, 29 April 2008, transcript 2401.30-36.
- 200 Alison Jux, Tweed Heads hearing, 29 April 2008, transcript 2401.34-2402.3.
- 201 Alison Jux, Tweed Heads hearing, 29 April 2008, transcript 2401.3-6.
- 202 Suzanne Samuels, Nepean Hospital hearing, 8 April 2008, transcript 1394.33-46.
- 203 Amanda Short, Coffs Harbour hearing, 27 March 2008, transcript 951.36-45.
- 204 Amanda Short, Coffs Harbour hearing, 27 March 2008, transcript 951.40-47.
- 205 Dr Jeremy Hsu, Westmead hearing, 10 April 2008, transcript 1499.13-15.
- 206 Dr Jeremy Hsu, Westmead hearing, 10 April 2008, transcript 1498.30-31.
- 207 Dr Jeremy Hsu, Westmead hearing, 10 April 2008, transcript 1498.33-35.
- 208 Dr Jeremy Hsu, Westmead hearing, 10 April 2008, transcript 1498.45-1499.2.
- 209 Dr Jeremy Hsu, Westmead hearing, 10 April 2008, transcript 1499.43-1500.14.
- 210 Dr Jeremy Hsu, Westmead hearing, 10 April 2008, transcript 1500.37-45.
- 211 Dr Randall Greenberg, Dubbo hearing, 19 March 2008, transcript 645.31-36.
- 212 Submission of Kenneth Gander, 1 April 2008, SUBM.023.0284 at 284.
- 213 Submission of Kenneth Gander, 1 April 2008, SUBM.023.0284 at 284.
- 214 Submission of Michelle Lewis, 26 March 2008, SUBM.010.211 at 212.
- 215 Submission of Michelle Lewis, 26 March 2008, SUBM.010.211 at 212.
- 216 Confidential Westmead hearing, 26 May 2008, transcript 40.5-7.
- 217 Confidential Westmead hearing, 26 May 2008, transcript 40.5-10.
- 218 Confidential Westmead hearing, 26 May 2008, transcript 40.21-24.
- 219 Confidential Westmead hearing, 26 May 2008, transcript 41.29-33.
- 220 Submission of Dr Richard Cracknell, 3 March 2008, SUBM.003.0202 at 204-205.
- 221 Submission of Dr Richard Cracknell, 3 March 2008, SUBM.003.0202 at 204-205.
- 222 Dr Roslyn Crampton, Westmead hearing, 10 April 2008, transcript 1516.45-46.

- 223 Dr Roslyn Crampton, Westmead hearing, 10 April 2008, transcript 1516.35-39.
- 224 Dr Roslyn Crampton, Westmead hearing, 10 April 2008, transcript 1516.39-43.
- 225 Confidential Wollongong hearing, 14 April 2008, transcript 49.24-26.
- 226 Confidential Wollongong hearing, 14 April 2008, transcript 49.26-30.
- 227 Confidential Wollongong hearing, 14 April 2008, transcript 49.32-36.
- 228 Confidential Wollongong hearing, 14 April 2008, transcript 49.36-39.
- 229 Confidential Wollongong hearing, 14 April 2008, transcript 49.41-44.
- 230 Dr Gregory Purcell, Royal North Shore Hospital hearing, 14 March 2008, transcript 417.20-26.
- 231 Dr Gregory Purcell, Royal North Shore Hospital hearing, 14 March 2008, transcript 417.28-28.
- 232 Dr Gregory Purcell, Royal North Shore Hospital hearing, 14 March 2008, transcript 418.6-18.
- 233 Rosalyn Ferguson, Hornsby hearing, 11 March 2008, transcript 226.17-19.
- 234 NSW Health, *Special Commission of Inquiry Presentations: NSW Health Workforce*, 4 April 2008, p. 4.
- 235 Submission of NSW Nurses' Association, March 2008, SUBM.042.0335 at 341.
- 236 Submission of Patricia Bradd, NSW Health Area Directors of Allied Health Council, 28 March 2008, SUBM.002.0177 at 3.
- 237 Meeting with Institute of Medical Education and Training, 3 April 2008, transcript 43.25-30.
- 238 Submission of NSW Nurses' Association, September 2008, SUBM.095.0001 at 11.
- 239 Submission of NSW Nurses' Association, September 2008, SUBM.095.0001 at 13.
- 240 Confidential hearing at the Inquiry's offices, 13 June 2008, transcript 17.43-46.
- 241 Confidential hearing at the Inquiry's offices, 13 June 2008, transcript 17.46.
- 242 Confidential hearing at the Inquiry's offices, 13 June 2008, transcript 17.46-18.2.
- 243 Confidential hearing at the Inquiry's offices, 13 June 2008, transcript 18.2-7.
- 244 Confidential hearing at the Inquiry's offices, 13 June 2008, transcript 18.7-9.
- 245 Confidential hearing at the Inquiry's offices, 13 June 2008, transcript 18.29-35.
- 246 Confidential hearing at the Inquiry's offices, 13 June 2008, transcript 20.4-12.
- 247 Confidential hearing at the Inquiry's offices, 13 June 2008, transcript 20.1-2.

12 Bullying & workplace culture

What is bullying?	400
Definitions	400
Types of bullying behaviours	401
What is not bullying	402
Experience of NSW Health workers	402
Doctors	402
Nurses	404
Allied Health workers.....	408
NSW Ambulance Service	409
Management.....	411
“Horizontal” bullying.....	412
Other evidence	412
NSW Health’s approach to bullying	413
Risk management approach.....	413
NSW Health policies and procedures.....	414
Workplace culture	415
“Just Culture”	417
Implementing “Just Culture” into other workplace behaviours	419
Implementation of “Just Culture” in NSW Health.....	420

- 12.1 During public and private hearings of this Inquiry, 35 people gave evidence about bullying and harassment they had experienced or had observed in NSW public hospitals. These witnesses included nurses, doctors and allied health workers from a wide variety of disciplines, together with people in management.
- 12.2 In addition, I received 43 submissions concerning bullying and harassment and 47 submissions concerning workplace culture in NSW public hospitals. During the course of the many visits which I undertook, I also received a large number of complaints about bullying and harassment.
- 12.3 I also met with Judith Meppem PSM, former Chief Nursing Officer for NSW, who has 43 years experience in nursing, midwifery and nursing management in both rural and metropolitan NSW hospitals, to obtain her perspective on bullying and harassment in NSW public hospitals. Ms Meppem discussed two reviews she completed in 2007 and 2008 into allegations of bullying and harassment at Royal North Shore Hospital and Wollongong Hospital respectively.
- 12.4 Further, I reviewed the evidence given and public submissions (some 190) made to the NSW Parliament, General Purpose Standing Committee No. 2 Inquiry into the management and operations of the NSW Ambulance Service (**Parliamentary Inquiry**), established on 15 May 2008, with respect to bullying and harassment in the NSW Ambulance Service. The evidence and submissions gave graphic and detailed accounts of bullying and harassment in the NSW Ambulance Service. A further 54 confidential submissions were made to the Parliamentary Inquiry which, despite my request, were not made available to me so I was not able to review them. I refer to the recently published report of the Parliamentary Inquiry below.

What is bullying?

Definitions

- 12.5 NSW Health describes workplace bullying as unreasonable behaviour in the workplace, or in the course of or related to employment that will **generally** meet all of the following criteria:
- (a) it is repeated;
 - (b) it is unwelcome and unsolicited;
 - (c) the recipient considers the behaviour to be offensive, intimidating, humiliating or threatening; and
 - (d) a reasonable person would consider the behaviour to be offensive, intimidating, humiliating or threatening.¹
- 12.6 A joint NSW Health, Public Service Association and Nursing Association statement issued in 2002 said:

"Bullying, harassment and discrimination includes a wide range of unwelcome and unsolicited behaviours that are largely defined by the offended person. Generally bullying involves persistent long term behaviour that intimidates, offends, degrades or humiliates an employee. To be able to bully, the person must have organisational

or personal power over the victim, and must be willing to abuse this power.”²

- 12.7 In giving evidence before the NSW Parliamentary Inquiry into the Management and Operations of the NSW Ambulance Service, Mr John McDonald, director of ProActive ReSolutions offered the following “plain English” definitions:
- Bullying is “I’m behaving badly towards you and I intend to”.
 - Harassment is “I am behaving badly towards you and I may or may not intend to”.
 - Vilification is “I am going to humiliate you publicly because of the group you belong to”.³
- 12.8 The common themes of less favourable treatment, intentional, inappropriate, humiliating, unreasonable, threatening, degrading, offensive or unwelcome behaviour and misuse of a power relationship, lie at the core of bullying.

Types of bullying behaviours

- 12.9 There is a plethora of workplace behaviours that can be characterised as bullying. NSW Health policy and guideline documents give the following examples:
- verbal abuse;
 - exclusion from receiving information or workplace social interactions;
 - belittling or undermining sarcasm;
 - touching, pushing, standing over;
 - damage to personal property;
 - persistent teasing;
 - watching and following;
 - threats of dismissal or use of organisational processes to offend, intimidate, humiliate or threaten;
 - regularly allocating the heaviest workload to a particular staff member;
 - blocking reasonable access to professional development or leave entitlements;
 - subjecting the work of a particular staff member to unwarranted excessive scrutiny;
 - mobbing, which is the malicious, deliberate attempt by co-workers to force a person (be they a peer, supervisor or manager) out of the workplace through harassment, humiliation or unjust accusations.⁴
- 12.10 Other examples provided by the NSW Department of Premier & Cabinet include:
- being subjected to constant ridicule and being put down in front of colleagues;
 - being the victim of loud and abusive, threatening or derogatory language usually when other employees are present;
 - leaving offensive messages on email or by telephone, including offensive messages through the use of SMS and material posted on the internet; and
 - being subjected to practical jokes.⁵
- 12.11 Bullies can be managers, supervisors, fellow workers, clients or members of external organisations. During this Inquiry, I heard evidence of bullying between:
- doctors and doctors;
 - doctors and nurses;
 - doctors and allied health workers;
 - doctors and patients;

- doctors and families of patients;
- nurses and nurses;
- nurses and allied health workers;
- nurses and patients;
- nurses and families of patients; and
- allied health workers and allied health workers.

What is not bullying

12.12 Legitimate managerial actions are not bullying. Management of any organisation has a prerogative to direct and control how work is done in the workplace, as a necessary incident of the employment relationship.

12.13 NSW Health recognises the following as legitimate managerial actions:

- providing constructive feedback on a staff member's work performance;
- managing performance or underperformance issues;
- transferring, terminating or taking action to make a staff member redundant where the process is conducted fairly and equitably;
- taking justifiable decisions related to recruitment, selection and other development opportunities;
- allocating work in compliance with systems and policies;
- ensuring that workplace policies are implemented;
- undertaking disciplinary procedures for proven misconduct, or for actions involving significant breaches of other policies; and
- overseeing injury and illness processes in accordance with occupational health and safety, injury management and workers compensation legislation and policies.⁶

Experience of NSW Health workers

12.14 I have received a large volume of material containing general allegations of bullying and harassment in the public hospital system. I have also received specific allegations pertaining to individual cases. Many of these are contained in confidential submissions or evidence taken in private, at the request of complainants.

12.15 With one exception (outlined in Appendix 8), it has not been possible to investigate individual complaints and determine their merits. However, it is important to set out in some detail at least the perceptions of bullying in its many forms of discrimination and racism within the NSW public hospital system. In recording these examples, I have not reached any conclusions as to the individual allegations, but I have no doubt, given the material before me, that there is a negative culture in NSW public hospitals which at worst manifests itself in bullying and harassment, but which also reflects a great divide between clinicians and administrators. The following review of evidence shows examples of both.

Doctors

12.16 The Inquiry received evidence and submissions from doctors of many instances of bullying and harassment. This material was contained in a number of confidential submissions or in private hearings. The vast majority of people who told me about bullying and harassment asked that their identity be kept confidential. I have not

therefore conducted an inquiry into the ultimate issue as to whether or not the conduct complained of was bullying or harassment, with the exception of the instance which I outline in Appendix 8. However, the evidence demonstrates dysfunctional relationships between management and clinicians in many NSW Health establishments. These issues are considered elsewhere in this report.

Examples of bullying - doctors

- 12.17 Some doctors described as bullying the behaviours of other doctors and administrators in response to a challenge to a new rule, lodging a complaint or merely “speaking out”. This response, I was told, engendered a fear of retribution:
- I was told that there is a culture of very quiet but very persistent bullying from the top down, exemplified by intimidatory language and behaviours. When a doctor complained about lack of consultation concerning the amalgamation of pathology services, 2 senior managers claimed the doctor was “badly out of line” and said they had been asked by the chief executive to talk to the doctor, who was given no opportunity to respond.⁷
 - Following a doctor’s refusal to accept a workforce restriction, which necessitated resigning either as a staff specialist or as a VMO, and objection to intimidation from the Area Health Service, the doctor told me that his VMO payments were withheld for a “long time”; he believed this was in retaliation for his refusal.⁸
 - When a doctor spoke out publicly expressing concerns about planned service capacity changes, I was told that allegations of bullying were made against the doctor and investigated by a person with whom the doctor had had disagreements over clinical issues. The doctor told me that while he was not dismissed from the hospital, he was offered only a 12 month reappointment at another hospital in the same Area Health Service. The doctor made the observation to me that senior managers need to lead by example to rid NSW Health of bullying.⁹
 - I was told that disciplinary action, and subsequent dismissal, were imposed as retribution for speaking out.¹⁰
 - A specialist doctor, with 10 years experience in the public health system, submitted that all nursing staff and most medical staff feel threatened and unable to speak out about patient care concerns in the health system. Staff experience bullying and intimidation tactics by management, which prevent them from being able to address their concerns.

“Staff in all disciplines is exhausted by the daily obstacles encountered, the recurring failures in care identifying the same problems which are never addressed, and the ongoing and constant decline in hospital care. Some have stopped ‘swimming against the current’, some turn a blind eye to glaring inefficiencies, some change departments in hope for a positive change, some leave the public system moving to the private and some who are completely disillusioned, leave the Medical Profession altogether.”¹¹

- A doctor explained the need to give evidence privately because of the “totalitarian environment” and the “fear of retribution” for both the doctor personally and the departments for which the doctor is responsible:

“We live in a micromanaged hell, a micro-mismanaged hell. It is run with a top-down culture of bullying and with the bottom-up response of fear and loathing.”¹²

- I was told that staff in some facilities in the Sydney West Area Health Service operate daily in a climate of fear, which is detrimental to providing quality patient care, destructive to education and training and contrary to NSW Health and Area Health Service policy. The public hospital system was described as dysfunctional, and micromanaged by non-clinicians to minimise unfavourable publicity as the highest imperative. The doctor submitted that the culture needs to change and existing policies need to be appropriately and consistently applied.¹³
- One doctor said,¹⁴

"A doctor who chooses to speak out can expect to be threatened in some way. Managers have no compunction about threatening doctors who speak out publicly about deficiencies in the service or even those who just simply expect a simple clinical process to go according to the way it goes everywhere else."

12.18 I was told of practices of unequal treatment by other hospital staff:

- An overseas trained doctor complained of discrimination, racism, mis-information about salaries and reimbursement of relocation costs and a lack of procedural fairness. This, I was told, led to resignations from good foreign-trained doctors resulting in cost increases in having to replace them, and lack of continuity of patient care. The doctor told me his treatment of a patient was initially found to be negligent. However a subsequent review by two professors reported no departure from accepted medical practice in that specialty. Nonetheless, the doctor's contract was not extended and no right of reply was given. The following comment was made by the doctor in relation to overseas trained doctors:

"There's a general attitude of exploitation, loathing, hysteria and paranoia around the service we provide. The successes we achieve are downplayed because of who we are and little oversights we make are blown up into disasters. It's the lack of dignity, the lack of being able to do anything about our circumstances that cuts so deeply."¹⁵

- A doctor told me that he resigned from the Emergency Department after working there for 5 years. While no patient complaints had ever been made against the doctor, he had difficulties with the director of the Emergency Department, whom the doctor believed disliked him personally, and was trying to get rid of him. The doctor received a warning letter, less favourable contractual terms in his next contract, and "punishment" by way of unfavourable rostering practices.¹⁶

Nurses

- 12.19 In greater volume than any other group of health professionals, I heard evidence and received submissions from nurses of bullying and harassment experienced in NSW public hospitals.
- 12.20 The NSW Nurses' Association complained that bullying and harassment is endemic in NSW public hospitals. The Association submitted there is an underlying culture of fear and intimidation embedded throughout the entire public health sector and grievances can take over 12 months to resolve. The Association advocates a new approach, placing emphasis on appropriate workplace behaviours, resilience, emotional intelligence, effective communications, and conflict resolution. Training in appropriate workplace behaviour and staff surveys are needed to monitor organisational performance.¹⁷
- 12.21 Ms Tracey Osmond, Chief Executive of the College of Nursing noted that:

"... despite excellent, comprehensive policies from the Health Department there are still issues at a local level regarding bullying and harassment."¹⁸

12.22 I was told that the anti-bullying policy is not effective at Royal North Shore Hospital. Nurses have nowhere to go to complain about bullying. They are told to take up the issue with their managers, but it is the managers who are the bullies, or so it is alleged. It was suggested to me that there be an annual anti-bully awareness day and a whistleblower hot-line.¹⁹

12.23 One nurse described a culture of harassment, intimidation and bullying, and said that NSW Health policies are worthless:

"Just because something is written on a piece of paper doesn't mean it has to be practised. I think generally because nurses are giving people, that really want to help, a lot of them sit back and just take things that aren't necessarily right."²⁰

12.24 I was told bullying takes many forms. Some nurses complained about the way they were treated by their supervisors and managers:

- A director of mental health services was described as having a dictatorial and autocratic management style. People were afraid to say anything for fear of being "instantly put in your place". Disciplinary processes were used to pursue personal vendettas. Staff were working with a sense of fear – people were whispering and hiding in corners, afraid that everything they do and say was being scrutinised.²¹
- I was told of an "authority gradient", said to be culturally entrenched in clinical practice:²² nurses don't have the right to question doctors because of the different levels of education and training; there is an air of arrogance that doctors display towards nurses who are made to believe they don't have the right to question and should not question.
- A clinical nurse specialist told me that she was chastised by her manager for being forthright about advocating the addition of a particular service:

"I was told I had behaved very, very badly, that if I was her child, she would lock me in a room and keep me there and that I needed to realise that I needed to just be quiet and settle down ... It is irrational behaviour. I think it stems from incompetent people being placed in positions where they are unable to perform."²³

- In Newcastle, I was told that some administrators treat senior nursing staff "like children", while senior nursing administration turns a blind eye to surgeons who bully and harass staff.²⁴
- At Westmead, I was told that there had been 22 resignations in 3 months in a department due to bullying and harassment. The Nurse Unit Manager said that, while the "zero tolerance" policy was being disseminated by the Area Health Service, bullying is prevalent. The causes could be people trying to create a niche to justify their positions, the traditionally hierarchical structures of hospitals, or people asserting their power over others.²⁵
- A group of neonatal intensive care nurses felt they were harassed and bullied - treated like children by management and ignored.²⁶
- An administrator was described to me as having a dismissive attitude of not listening to nurses who raised issues about a dispute between them with the administrator.²⁷

- A clinical nurse consultant told me that she left after 17 years working in a specialty medical area due to 6 months of one-on-one bullying by her manager, comprising hostile body language, verbal hostility, marginalising, refusing to make eye contact and have meetings. This was said to be symptomatic of a culture in NSW Health of bullying, cover-up, lying and “protecting your mates”.²⁸

12.25 Other forms of “bullying” were raised with me by nurses, who claimed that:

- At Wollongong midwives are pressured to work a greater workload. If they don’t, they will not be looked at favourably when rostering is carried out. Midwives are reluctant to report bullying for fear of retribution.²⁹
- There are inequitable rostering practices, bias and bullying.³⁰
- One nurse gave me a number of examples of what she regarded as bullying including problems with salary payments, occupational health and safety concerns being ignored, unfair dismissal, cancellation of appointments with Human Resources staff without notice and dismissive responses to bullying concerns.³¹
- A midwife complained about threats of disciplinary action if cord blood was not collected from each delivery, however the midwife later conceded that she was aware that the cord blood samples were being collected for a research project, which was appropriate.³²

In my view, these three complaints are certainly grievances, but may not necessarily amount to bullying.

12.26 I heard numerous complaints about NSW Health’s management of grievances and complaints:

- A nurse with 27 years experience at Royal North Shore Hospital complained of being bullied. She told me bullying caused a dysfunctional environment that impacted on patient care. Furthermore, she said making a complaint about bullying is “professional suicide”, and complaint handling procedures are characterised by long delays, which are put in place to placate complainants, who think something is being done, when it is not.³³
- I was told that there is a low level of confidence about the way complaints, grievances and protected disclosures are dealt with and there is limited feedback on incident reporting. Nurses and midwives believe there is a culture of bullying and intimidation within upper management ranks in the Illawarra.³⁴
- A nurse gave evidence that, while an investigation into a complaint against her was not upheld, she went through “three months of hell”, and was not allowed to review patient notes to assist in her response.³⁵
- A clinical nurse consultant at Prince of Wales Hospital told me that she left the profession after 30 years, following a lengthy investigation into allegations against her that were ultimately not substantiated. The complainant was appointed to the clinical nurse consultant’s position when she was stood down; however, the clinical nurse consultant was unable to return to her position at the conclusion of the investigation, as it had been down graded. The clinical nurse consultant was very critical of the investigation process and the behaviour of an investigator and the return to work coordinator.³⁶
- Another nurse said that a complaint made against a doctor of bullying and harassment “disappeared” from the complaints system after 12 months and was never dealt with or finalised. The complainant and other witnesses were and continued to be in fear of the doctor.³⁷

- Management of a complaint of bullying by fellow workers was described as characterised by bias, lack of procedural fairness, a refusal to provide documents and took 5 months to complete. The complainant suggested that an independent agency be established to ensure grievance investigations are conducted appropriately.³⁸
 - I was told that there were lengthy delays in delivering training to managers and nursing staff on bullying prevention, despite an external consultant having been engaged.³⁹
- 12.27 A number of nurses told me of their fear of retribution if they “spoke out”, made a complaint or even made suggestions for improvement:
- Staff told me they were reluctant to make formal grievances due to inequitable rostering “paybacks”.⁴⁰
 - I was told that persecution and retribution for speaking out is real, including a permanently bad roster, no opportunity for promotion or losing your job. Senior management in some hospitals were described as bullies who were unapproachable and dictatorial:

“There is a culture of silence, apathy and disenchantment within staff. No one is encouraged to speak out about the failings of the system ... There is no trust. If we cannot speak out about serious concerns in confidence to anyone without fear of retribution, how can they ever be fixed. Indeed they cannot.”⁴¹
 - A group of Nurse Unit Managers said they were afraid of reprisals and too afraid to speak out publicly. They complained of being attacked, abused and threatened by Directors of Nursing, and said that fear and intimidation have silenced Nurse Unit Managers at all levels.⁴²
 - Another nurse explained that it was necessary to give evidence in camera because the Area Health Service has a history of harassment, intimidation and bullying which the nurse had herself experienced.⁴³
 - A Nurse Unit Manager at Concord, speaking representatively for a number of people afraid to come forward because of possible repercussions, told me that there was bullying by a group of administrators known as the “Girls Club”, whose usual tactic was to restructure, or make false claims against individuals.⁴⁴
 - A Nurses’ Association delegate said that senior nursing staff tend to be bullies and gave an example of a nurse who was moved from her position as a result of “whistleblowing”.⁴⁵
 - A Nurse Unit Manager at Bankstown complained of being bullied and believed it was retribution for complaints by multi-cultural nurses on her ward about a nurse educator’s behaviour and ethnicity-related comments.⁴⁶
 - I was told that reporting honesty is punished and mistakes are covered up for fear of the process of “fact finding” exercises. Reporting colleagues results in isolation bullying (being “sent to Coventry”).⁴⁷
 - Nurses said they have no professional or personal protection against career and financial losses, if they speak out.⁴⁸
 - Hospitals were said to thrive on a culture of fear, where anyone who speaks out in disagreement with management is marginalised. There is also “favouritism” amongst nurses – unit management allow friends to have more favourable rosters and promotional positions.⁴⁹
 - After more than 3 decades of unblemished conduct as an enrolled nurse at the one hospital, the nurse queried why government policy was not being followed:

"That was the start of three years of on-going bullying in the work place, beat up and false allegation. Not once did I ever see a complaint in writing or signed. You face a stressful meeting called a 'fact find'. These inquiries can be strung out over many months. If possible they would find you guilty, usually it is for breaking the Code of Ethics, unprofessional behaviour or inappropriate behaviour. The next time the penalty is harsher because of your previous history. They are the judge and jury. It does not matter what you say or do they can write what they like, twist things as they like and within a very short time what they write becomes documented history. Human Resources always support and back up management. The nurses at Royal North Shore Hospital call speaking out 'Career Suicide' I called it Crucifixion [sic] by Documentation."⁵⁰

Allied Health workers

12.28 Bullying and harassment is also experienced by allied health workers, with similar themes as those described to me by nurses and doctors:

- A pathology technician described a workplace culture of bullying characterised by a lack of dignity and respect in the workplace, intimidation, bullying, harassment, sexual harassment, leaking confidential information, emotional blackmail, misinformation, victim blaming, and discriminatory work practices to control and subdue staff. Staff were said to adapt by "learned helplessness".⁵¹
- I was told that major restructures in NSW Health have resulted in many allied health staff being "in limbo", acting in positions. They harbour fears about the workplace consequences of appearing to be critical of the organisation. There is fear of retribution from management.⁵²
- One allied worker said that time constraints have been used to set people in competition with each other in the name of productivity improvements, instead of promoting cooperation and communication, and this is the "perfect breeding ground for bullying".⁵³
- A social worker told me that friendship is the basis for recruitment and retention of staff. Managers police certain staff by excessive scrutiny. Some individuals are targeted for humiliation at staff meetings and one-on-one interrogations. There is also harassment by preventing staff from attending workshops and rejecting leave applications.⁵⁴

12.29 Allied health workers were also critical of complaint handling processes:

- One allied health worker told me that a complaint about a manager's bullying, bad behaviour, favouritism and negative discrimination took 5 months for Human Resources to action, after trying to dissuade the complainant from proceeding with the complaint. An appeal found the manager's behaviour was not bullying and noted there was a fine line between bullying and bad communication. The allied health worker suggested that all complaints of bullying should be dealt with outside the Area Health Service.⁵⁵
- A grievance filed at Royal North Shore complaining about the conduct of a doctor was not resolved after 8 months. Human Resources apparently discouraged the complainant from making the grievance, as they were short-staffed. The grievance was then passed from officer to officer. The complainant has since been told the doctor will not apologise.⁵⁶ No other resolution has occurred

12.30 Like doctors and nurses, allied health workers expressed fears of retribution if they "spoke out" or made complaints:

- One allied health worker said that people are afraid to speak out because of possible negative repercussions; it takes courage to speak the truth and suffer the consequences and there is anecdotal evidence that bullying and harassment occur when people have spoken openly about the realities of their workplace. People are not allowed to talk to anyone outside the unit.⁵⁷
- A social worker told me that staff harboured fears about the workplace consequences of appearing before the Inquiry. They perceived that their observations would be discounted at best and dismissed at worst, and they may be subjected to chastisement and bullying by managers as a result. Front-line clinical operations managers were said to live in fear of retribution from senior management.⁵⁸

NSW Ambulance Service

- 12.31 I received one submission from a paramedic in relation to bullying and harassment. The ambulance officer complained of bullying by the hospital when he lodged an incident report concerning the hospital's decision to transfer a patient in the final stages of labour to another hospital. While the ambulance officer was querying the hospital's decision with the NSW Ambulance Service station officer, the baby was born. The hospital manager complained to the station officer about the paramedic's criticism in the incident report and claimed the paramedic had incited the patient to complain:

"...it is an emotionally taxing experience to have to add to one's duties the concern that one may be bullied into overseeing the maltreatment of hospital patients."⁵⁹

- 12.32 As noted above, the NSW Parliamentary Inquiry into the Management and Operation of the NSW Ambulance Service received a large number of submissions concerning complaint handling, bullying and harassment in the Ambulance Service⁶⁰, including evidence of:

- (a) Widespread acceptance by management of bullying behaviours including verbal abuse, spreading rumours, making of false complaints and ensuing frivolous investigations, preferential treatment to "favourites" and discriminatory treatment of those that are not, isolation and derogatory remarks;
- (b) fear of retribution for "speaking out";
- (c) mishandling of investigations characterised by poor and inconsistent investigation methods, lengthy delays in finalising investigations and lack of procedural fairness; the Professional Standards & Conduct Unit was widely criticised by ambulance officers for its lack of competence.⁶¹

- 12.33 Much publicity was given to the tragic case of Mrs Christine Hodder, the first female ambulance officer to serve at Cowra Ambulance Station, who committed suicide in 2005. In a submission to the NSW Parliamentary Inquiry, Mrs Carolynn Hodder said:

"Harassment, intimidation and bullying and its consequences are very well documented and there is supposed to be a Policy of "Zero Tolerance" towards it. We must all obey the rules. Those in higher management have to be accountable, especially when they are approached directly through the correct channels to resolve issues. Christine's situation should have been sorted out before it reached this terrible conclusion. Your department needs to ask some serious questions of the NSW Ambulance Service for instance; why they have allowed these types of behaviours to continue to the point where people from that one station are transferring away, going on stress leave and in Christine's case

becoming so demoralized and depressed that she committed suicide.

It seems the service has a warped view of its Bullying and Harassment policy. Instead it seems to have a zero tolerance toward victims of this behaviour and the victims are then subject to the same type of behaviour from higher management. It's a very ugly unsafe department for its employers [sic] and will be until this culture changes ... We have since been told about many bullying, intimidation and harassment problems faced by others in the ambulance [sic]. So no lessons have been learned."⁶²

- 12.34 Before the NSW Parliamentary Inquiry, the Director-General of NSW Health, Professor Debora Picone gave evidence of NSW Health's "zero tolerance" policy towards bullying and harassment. She noted that international studies have revealed that the incidence of verbal abuse and bullying in industrialised countries is between 10 and 20 per cent. Professor Picone said NSW Health's code of conduct sets the tone for NSW Health and makes it very clear to people that bullying and harassment is not acceptable. A bullying and harassment task force was established in 2007 by the NSW Ambulance Service and by the end of 2009, all 400 managers in NSW Health will have completed training in bullying and harassment. However, Professor Picone also noted:

"I do believe that there are pockets of bullying and harassment in [the NSW Ambulance Service], and I believe that we have to work diligently to stamp that out. It is not accepted, under any circumstances."⁶³

- 12.35 In its answers to additional questions on notice from the NSW Parliamentary Inquiry,⁶⁴ NSW Health said that professional practice units have been established across the NSW Health system since 2000 to conduct transparent and objective investigations into serious complaints and grievances by staff and patients. In the Ambulance Service context, the Professional Standards & Conduct Unit is the equivalent of a professional practice unit:

"Established in 2000, the Unit provides expert guidance, advice and case management in respect of allegations of misconduct, consumer complaints and staff grievances and complaints."⁶⁵

- 12.36 According to NSW Health, the NSW Ambulance Service has, in 2008:
- increased the investigation staff of the Professional Standards & Conduct Unit by two;
 - refined its case management practices to include increased involvement of operational managers and personnel from workforce;
 - engaged IT consultants to develop a case management system to streamline case processing;
 - been working on delivering better organisational responses to workplace conflict and complaints of bullying and harassment.

- 12.37 These measures will, according to NSW Health:

"... ensure the PCSU [Professional Standards & Conduct Unit] concentrates on and responds in a timely way to serious misconduct matters."⁶⁶

- 12.38 The NSW Ambulance Service also convened a Health Workplace Behaviours Forum on 28 May 2008, at which 100 Ambulance Service staff from different occupational groups

and levels throughout NSW participated. The Forum produced the following recommendations, which are being implemented by the Ambulance Service:

- a review of all policies and procedures;
- training for all staff in managing workplace conflict; and
- making bullying and harassment a joint responsibility between staff and managers.

Finally, the NSW Ambulance Service has created a role of Healthy Workplace Strategy Manager “to coordinate services to manage and monitor swift resolution of staff grievance and complaints and workplace conflict through restorative practices and mediation, and policies, procedures and programs”.⁶⁷

- 12.39 On 20 October 2008, the report of the NSW Parliamentary Inquiry into the management and operations of the NSW Ambulance Service was published.⁶⁸ The report was critical of the culture and management of bullying and harassment in the NSW Ambulance Service. It made recommendations to strengthen NSW Ambulance Service management’s performance and accountability, including recommendations to improve grievance handling by clarifying and simplifying grievance procedures, increasing resources to the Professional Standards and Conduct Unit and ensuring the provision of impartial grievance advisory services to staff.

Management

- 12.40 I heard descriptions from a number of doctors and nurses as to the conduct of hospital administrators which they considered to be bullying and intimidatory, some of which were said to impact adversely on patient care. It is necessary, particularly in this context to keep in mind the fine line which can exist between legitimate management activity and discretion on the one hand and bullying and unacceptable behaviour on the other.
- 12.41 Lack of consultation of clinicians by hospital administrators was raised in this context:
- I heard evidence that NSW Health functions with “no consultation” as its guiding principle. When something is exposed publicly, the standard response is to first deny the problem, then when the evidence becomes overwhelming, NSW Health tries to blame someone either within or without the department. The end solution is then to sack someone often with minimal natural justice, quite unfairly.⁶⁹
 - A doctor claimed that administrators take action without consultation, discussion or notification including secretly decreasing staff and resources. I was told that there is a lack of accountability of administrators for their actions, particularly in relation to NSW Health policies dealing with harassment in the workplace: processes are not in place to enable the policies to be followed, resulting in delays and unreasonable investigation reports that the doctor described as “Monty Pythonesque”.⁷⁰
 - Conjoint Professor John Duggan submitted that morale in medical staff is at “rock bottom”. In his opinion, senior staff have no role or contact with the administration, and have become *de facto*, impotent, part time contract workers. Professor Duggan complained that bullying is rife in the public health care system:

“The problem reaches down the chain to the ward nursing staff where senior nursing staff find themselves with inadequate staffing but yet are expected and expect to deliver nursing standards whatever the human cost.”⁷¹
- 12.42 The following specific allegations of bullying behaviours were raised with me:

- Dr Fisher at Dubbo Hospital described how efforts to find an available bed for a patient can lead to harassment and bullying, and a very unpleasant workplace.⁷²
- Administrative processes were described as being so cumbersome that junior doctors cannot make overtime claims, leading to under-payment for hours worked. This was categorised as on-going systemic bullying and poor treatment.⁷³
- The Director of the Intensive Care Unit at St Vincent's Public Hospital, Dr Wright, told me that lack of credibility of directors of nursing (in terms of bedside nursing experience) can lead to situations where administrators in hospitals are "forcing" decisions on them in circumstances where the nurses do not have the experience, or authority based on long clinical practice, to object, often to the detriment of proper patient care. Dr Wright said:

"If you have someone who has this bedside experience and credibility with the staff, you then generate amongst these middle managers and the clipboard people a situation where they come along and say 'What can I do to help you?' instead of saying 'What can we do to hinder you?' which is what happens in the majority of circumstances."⁷⁴

- 12.43 A medical scientist submitted that a culture of bullying among management was the cause of one of the highest grievance levels in the NSW health system, resulting in a massive turnover of staff, demoralisation, lowering the performance of good workers and economic loss. I was told that bullying complaints are almost never investigated properly, so bullying is tolerated.⁷⁵

"Horizontal" bullying

- 12.44 In all professions, I heard evidence of instances of "horizontal" bullying, that is, bullying between peers or co-workers:
- (a) a complaint of verbal abuse by another doctor in front of others in the operating theatre was made to the manager of the relevant facility; I was told the complaint was mismanaged and characterised by inordinate delays for over 12 months. The complainant believes there was no adequate resolution of the complaint.⁷⁶
 - (b) a Nurse Unit Manager spoke of "horizontal" bullying of staff who don't fit the emergency department mould:

"ED nurses think of themselves as pretty enthusiastic, high pace, rough and tough nurses, and if you don't fit that mould then often you do end up victimised. There is verbal abuse [between nurses] ... I think it is probably something that has contributed to it being an uncomfortable workplace for some, and hence we have ended up with a lot of vacancies. Not many steps have been made by hospital executives, if they are aware of it, to assist in dealing with that problem."⁷⁷
 - (c) a hospital manager told me that there is a long-standing culture of bullying amongst middle management in NSW Health and low level bullying amongst middle managers of each other. The manager said there seems to be acceptance among staff at the hospital that inappropriate behaviour is acceptable.⁷⁸

Other evidence

- 12.45 Ms Judith Meppem, PSM, told me in private conference on 15 July 2008 that there are systemic issues of bullying and harassment in all NSW hospitals. While NSW Health

policies are, in Ms Meppem's view, by and large comprehensive, they are not universally embraced or implemented appropriately, and strong leadership is needed to ensure that the rhetoric is matched by actual practices in the workplace.

- 12.46 Ms Meppen believes there is a clash of "generations" among nurses; younger, better educated nurses do not respond well to the "command and control" hierarchy that existed when senior nurses and administrators began their careers. Consequently, "Generation X" and "Generation Y" nurses perceive the behaviour of some of their superiors as bullying and intimidating, while their superiors are simply behaving as they were taught. Ms Meppen told me there is a fine line between bullying behaviours and the exercise of management prerogative, and she does not consider the demarcation between them is as clear in NSW Health policy as it might be.
- 12.47 The pressures of modern nursing, in terms of increased workload, pressures on staffing levels, skill mix⁷⁹ and problems with bed availability all contribute to creating a divide between clinicians and hospital administrators. There is a perception that administrators only focus on the "bottom line" and clinicians and nurses only focus on patient care. Working under such pressures may lead hospital staff to deal with each other abruptly and often rudely and often people do not perceive their behaviour to be offensive to others.
- 12.48 Ms Meppen told me she believes there has been a total failure of performance management of staff in NSW hospitals. Trouble spots are not identified and dealt with expeditiously, and grievance management and disciplinary processes are poorly managed. Ms Meppen advocates the implementation of robust grievance handling processes, with hard targets for resolving complaints; ordinary complaints should be resolved within a month, while more complex cases should have a target of 3 months maximum. Compliance (and non-compliance) with timeframes should be reported.

NSW Health's approach to bullying

- 12.49 In its submission to this Inquiry, NSW Health noted that:
- (a) it continues to work on the issue of violence and aggression in the workplace;
 - (b) it has introduced a clear "zero tolerance" policy and accompanying strategies to attempt to deal with these problems;
 - (c) improving the working environment for NSW Health staff will contribute to better patient care and improved staff morale.⁸⁰

Risk management approach

- 12.50 NSW Health adopts a risk management approach to the prevention of workplace bullying, based on the identification and quantification of risks, development of appropriate measures to eliminate or control those risks, and monitoring the effectiveness of the responses to the risks. Its policy states that:

"Like all foreseeable workplace risks, the potential for workplace bullying must be identified and assessed, and eliminated as far as possible. If the risk is unable to be eliminated, appropriate risk controls must be put in place."⁸¹

- 12.51 NSW Health has identified as risk controls:
- (a) preventative activities,

- (b) management activities,
- (c) standards, policies and procedures; and
- (d) training to eliminate, avoid or minimise the risk of harm.

12.52 These measures include:

- good physical workplace design;
- staff understanding of and commitment to the Code of Conduct;
- communication to all staff about bullying behaviours;
- ensuring grievance management processes work;
- senior management promotion of a bullying-free environment;
- encouragement of self-resolution of conflict;
- clear and simple processes for reporting bullying;
- equipping managers to respond promptly and effectively to bullying complaints;
- up-to-date position descriptions, so staff understand their roles and responsibilities;
- appropriate working schedules to allow staff to manage work, life and family responsibilities; and
- encouraging consultation and staff involvement in decision-making.⁸²

12.53 In accordance with standard risk management processes, NSW Health guidelines note that monitoring, reviewing and evaluation of the risk control program must be undertaken at least every one to 2 years. The guidelines provide that responsibility to evaluate the effectiveness of a workplace risk control program should be allocated to a senior manager, with staff being invited to participate in the evaluation process.⁸³

NSW Health policies and procedures

12.54 NSW Health has a suite of policies and procedures addressing workplace behaviours, in support of its “zero tolerance” of bullying and harassment. These include:

- (a) the joint anti-bullying statement, signed by major health unions and the Acting Director-General of NSW Health in 2001;⁸⁴
- (b) the joint anti-bullying statement, signed by the Public Service Association, the Nursing Association and the Acting Director-General of NSW Health in 2002;⁸⁵
- (c) a zero tolerance to violence policy, which acknowledges that bullying is “internal violence”, introduced in 2003;⁸⁶
- (d) a training program on preventing and managing violent behaviour in the NSW health workplace, introduced in 2003;⁸⁷
- (e) the NSW Health code of conduct;⁸⁸
- (f) policy and guidelines for grievance management, introduced in 2005 and 2007 respectively;⁸⁹ and
- (g) detailed guidelines for the prevention and management of workplace bullying, introduced in 2007;⁹⁰

12.55 NSW Health policies and procedures are detailed and comprehensive. On their face, they reflect best practice in NSW Government agencies, and are easily accessible on the internet. Of course, policies and guidelines alone are not enough. They need to be understood and implemented, at all levels of NSW Health.

Procedures for making a complaint

- 12.56 NSW Health guidelines contain detailed procedures for making and managing a bullying complaint. Complaints are to be handled sensitively and seriously and acted on promptly. Confidentiality of documents concerning the complaint must be assured. Straightforward complaints should be handled by the manager who receives the complaint; more complicated matters may require investigation by experienced and expert investigators. Mechanisms should be in place to evaluate whether the complaint management system is effective and timely.⁹¹
- 12.57 NSW Health guidelines contain guidance on treating complainants and respondents fairly and requires a risk assessment to be conducted of potential ongoing risks to both parties associated with current work arrangements. Neither the complainant nor the respondent should be unduly disadvantaged by any changes to workplace arrangements following this risk assessment.⁹²
- 12.58 Under NSW Health guidelines, an initial assessment is made to obtain a sense of the potential seriousness of the matter and whether it falls within the guidelines' definitions of bullying. If the complaint is a minor workplace issue, it should be dealt with under NSW Health's grievance resolution process. The guidelines are clear that serious workplace issues, such as bullying, must be managed in accordance with the prevention and management of workplace bullying guidelines.⁹³
- 12.59 At a NSW Health briefing, an area health service Chief Executive told me of their experience in NSW Health which was that front line managers need up-skilling, including mediation training; ideally by way of a recognised 5-day training course in mediation. I was told that without such training, people don't know what to do and tend to sit on their hands and do nothing which results in the worsening of the conflict. I was told that mediation training for front line managers and general managers was a good thing.⁹⁴

Workplace culture

- 12.60 From an analysis of the evidence I have received, there are some instances of perceived bullying or harassment that were not actually bullying or harassment. It appears that some health workers respond adversely to decisions that are legitimately made by their superiors or by hospital administrators, and some object to the way people communicate with them.
- 12.61 Some health workers object to participating in performance management, which is also a legitimate managerial activity.
- 12.62 Other evidence pointed to serious cases of bullying and harassment, many of which were not appropriately or expeditiously managed, contrary to the mandates of NSW Health policies and guidelines.
- 12.63 Most large organisations, in both the private and public sectors, have well developed conflict resolution processes. Documented, fair and appropriately implemented processes are necessary for organisations to discharge their workplace health and safety obligations to employees, contractors and volunteers.
- 12.64 While I consider that the framework of NSW Health's policies and procedures on prevention of bullying is both robust and comprehensive, there are serious deficiencies in their implementation.

- 12.65 In order for the framework to be effective:
- (a) adequate resourcing is necessary, both in terms of personnel and budget, for the proper implementation of relevant policies and guidelines;
 - (b) comprehensive training of, and support to, NSW Health supervisors and managers is essential for the successful implementation of NSW Health's "zero tolerance" (of bullying) policy; and
 - (c) a thorough process of monitoring and reviewing performance against the requirements of the "zero tolerance" policy is necessary, together with continuous improvement measures.
- 12.66 Above all, leadership by sustained senior management commitment and oversight is essential to the successful operation of conflict resolution processes in an organisational context.
- 12.67 I conclude from the evidence before me that:
- (a) there is a lack of understanding of, and commitment to, NSW Health's policies and guidelines in relation to workplace behaviours by all levels of staff, including senior management;
 - (b) there is a widespread feeling of distrust and anxiety in some hospitals about how staff deal with one another; this distrust extends to senior management, who are perceived to treat subordinates rudely and unequally, and generally to be uninterested and ineffective in dealing with complaints;
 - (c) the procedures for dealing with grievances and complaints are not effective, and staff have no faith that complaints will be dealt with appropriately and confidentially or that they will receive fair treatment; and
 - (d) NSW Health has, therefore, failed to successfully implement its risk management approach to the prevention of workplace bullying (see above).
- 12.68 In my view, the behaviours of staff in many NSW public hospitals are a reflection of a poor workplace culture. The workplace culture in NSW public hospitals is characterised by lack of respect and trust, absence of empathy and compassion, inability to celebrate the success of others, failure to communicate, and a lack of collaboration. Many managers are perceived to be ill-suited for their positions and therefore ineffective. Staff feel victimised and powerless.
- 12.69 Poor workplace culture is not conducive to good outcomes, especially in a public health environment. Poor outcomes for patients can have dire consequences. Many health workers told me that low morale in NSW public hospitals can and does impact adversely on patient care and patient safety.
- 12.70 One approach to improving workplace culture is to address organisational culture in a wider context. This has proven to be successful in the USA, where the principles of "Just Culture" have been adopted by health services, and in other industries where highly developed safety management systems are required. I discuss in some detail what one of the available designs of "Just Culture" involves below.
- 12.71 In general terms a "Just Culture" in a workplace is a culture:
- where the employer is accountable for the systems it has designed and for supporting safe choices by patients, visitors and staff;
 - where employees are accountable for the quality of their choices, not for the severity of the outcome when an error is made.

- that is characterised by learning from mistakes, openness and fairness, robust safe systems and the management of behavioural choices.
- 12.72 A “Just Culture” is to be contrasted with a “blame” culture, which tends to drive defensive and unsafe behaviours, failure to report and failure to improve from learning from mistakes.
- 12.73 Any large organisation faces a daunting task when introducing major change. NSW Health has around 118,000 staff. It has undergone significant change over the past decade. The organisation must continue to deliver highest quality health services expected by the NSW public while change processes take place.
- 12.74 Successful implementation of a “Just Culture” program into NSW Health’s workplace behaviours will take at least 5 years. However, the implementation program will be able to identify short, medium and long terms goals, so that some immediate successes can be achieved.

“Just Culture”⁹⁵

- 12.75 I note that Bret Walker, SC, in his 30 July 2004 *Final Report of the Special Commission of Inquiry into Campbelltown and Camden Hospitals* addressed “Just Culture” principles in chapter 5, *No-Blame v Individual Accountability*. In speaking of the division between “theoreticians” who like to collect, cultivate and categorise errors and “practitioners” who are interested in eliminating errors or controlling their effects by system changes, Commissioner Walker said:

“It follows from my comments above, and elsewhere in this Report and particularly in Chapter 3, that I think it is high time that the two camps struck their separate tents and travelled together.”⁹⁶

- 12.76 In 2001, David Marx, JD, engineer and attorney, published his *Patient Safety and the “Just Culture:” A Primer for Health Care Executives*, in which he identified the tension between an open learning culture and the need to hold individuals accountable for their actions. He developed the principles of “Just Culture”, which advocate people being accountable for their actions at a point that is mid way between the extremes of a punitive culture and a blame-free culture. This program is regarded widely throughout the world as a leading example of this philosophy.
- 12.77 David Marx has established the “Just Culture” Community, through his risk management firm, Outcome Engineering LLC, based in Texas, USA. “Just Culture” principles have been adopted by health services across Minnesota and North Carolina, USA.⁹⁷ “Just Culture” principles have been applied to safety management in the health, aviation, oil exploration and heavy rail industries.
- 12.78 In the health context, “Just Culture” is:

“a safety-supportive system of shared accountability where health care institutions are accountable for the systems they have designed and for supporting the safe choices of patients, visitors, and staff.”⁹⁸

- 12.79 Staff, in turn, are accountable for the quality of their choices, not for the severity of the outcome when an error is made.

“In a Just Culture, we report our errors, hazards, near-misses, and events so that when properly investigated, we can learn lessons, draw conclusions and make improvements that lead us to a more robust system design. A just

reporting culture gives us the opportunity to make safer choices, and guide us to better outcomes for those who receive our services as well as those for whom we work.”⁹⁹

- 12.80 As initially developed, the “Just Culture” program concentrates on the safety of the operations of a system such as the health system. It was in this context, that it was considered by Commissioner Walker.
- 12.81 But, as it seems to me, at its core is a set of principles which can, and ought be, applied to workplace behaviours generally. I give an example of this below. The reason it or something similar, can be applied, is because of the features which it articulates:
- (a) An open and fair workplace where each participant is entitled to dignity and respect;
 - (b) A workplace where it is recognised that learning and the sharing of learning is to be encouraged rather than discouraged; and
 - (c) A workplace which has and makes known a clear set of rules and guidelines about behaviour which are implemented consistently throughout the organisation.
- 12.82 In a “Just Culture” organisation, health care professionals have three duties:
- (a) the Duty to Produce an Outcome;
 - (b) the Duty to Follow a Procedural Rule;
 - (c) the Duty to Avoid Causing Unjustifiable Risk or Harm.

The Duty to Produce an Outcome

- 12.83 This duty requires health care professionals to be accountable for a set of outcomes. Examples include, in an employment context, time and attendance, proper attire, obligation not to steal or engage in harassment. I see no reason why this duty ought not encompass a zero tolerance of bullying and like behaviour.
- 12.84 The outcomes need to be:
- (a) known to the health care professional; and
 - (b) able to be produced.
- 12.85 The program recognises that there may be legitimate grounds for not producing an outcome in a given circumstance.¹⁰⁰ It further recognises that the risk of not producing an outcome in a given situation may be exceeded by the social benefit.¹⁰¹
- 12.86 In a “Just Culture” organisation, managers help employees to produce better outcomes; if that fails, some form of punitive or disciplinary action may be necessary for repeated, non-legitimate breaches of this duty.

The Duty to Follow a Procedural Rule

- 12.87 This duty requires health care professionals to follow a set of procedural rules established by the institution or employer, such as NSW Health.
- 12.88 The procedural rules need to be:
- (a) known to the health care professional; and
 - (b) able to be followed.

- 12.89 The procedural rule may be inadvertently violated or may be knowingly violated. A single instance of inadvertent violation would lead to the health care professional being “consoled” and the institution or employer would seek to understand what human factors were involved that increased the likelihood that the human error would occur.
- 12.90 The risk of knowing violation of a procedural rule might be outweighed by the social benefit. Even if there was no justification for the knowing violation, the health care professional may have had a good faith, but mistaken, belief that the violation was insignificant or justified.
- 12.91 In a “Just Culture” organisation, health care professionals who have a good faith belief that the violation was either insignificant or justified would be considered to have engaged in “at-risk” behaviour and would be coached and their behaviour investigated to better understand its source. However, if the health care professional did not have a good faith belief in the justification for the violation, they would be dealt with for reckless violation; punitive action may be necessary.

The Duty to Avoid Causing Unjustifiable Risk or Harm

- 12.92 This duty requires health care professionals, above other duties, not to cause unjustifiable risk or harm to others. The duty prohibits deliberate and reckless acts.
- 12.93 In a “Just Culture” organisation, when an incident occurs that causes harm or puts another person at risk of harm (personal injury or property damage), the health care professional’s motivation or purpose is determined:
- (a) Purposely causing harm is culpable or blameworthy behaviour that warrants punitive action.
 - (b) However, absent purpose, the health care professional may have knowingly caused harm for which punitive action could follow.
 - (c) Even if the person did not knowingly do so, they may have consciously disregarded the substantial and unjustifiable risk, and would be considered to have acted recklessly.
- 12.94 Punitive action may be necessary to respond to reckless behaviour. The behaviour needs to be assessed against the objective standard of whether a similarly situated person would have seen the risk and appreciated it being substantial and unjustifiable.
- 12.95 Repetitive at-risk behaviours in a “Just Culture” need to be analysed carefully and purpose designed solutions identified.

Implementing “Just Culture” into other workplace behaviours

- 12.96 Some organisations have sought to expand the “Just Culture” program into other areas of their business, that is, beyond organisational safety management systems.
- 12.97 Fairview Health Services in Minnesota, USA has recognised that, in order to properly implement “Just Culture” in patient safety, it is necessary to “eliminate the policies that don’t allow you to incorporate “Just Culture”.¹⁰² Fairview Health Services incorporated the language of “Just Culture” into organisational policies relating to employees, job descriptions, medical staff by-laws and codes of conduct, including disciplinary procedures and consequences:

“Our organisation is still in the process of incorporating just culture principles into policies, but we have eliminated the policy barriers to using the

principles. For example, if you have policies that authorize punishment (e.g., written reprimand or dismissal) after a certain number of errors, or that predicate punishment on the severity of the outcome, get rid of them.”¹⁰³

12.98 Rail Corporation New South Wales (**RailCorp**) implemented a “Just Culture” safety program in 2006, as a response to recommendations made by the Special Commission of Inquiry into the Waterfall Rail Accident in 2005. In 2007, RailCorp expanded its “Just Culture” program into the management of human resources and operational issues and incidents, to cover ethical and expected behaviours in the workplace.¹⁰⁴ The RailCorp “Just Culture” program¹⁰⁵ is made up of the following:

- (a) a Just Culture policy; and
- (b) a Just Culture framework and model,

both of which are supported by the RailCorp Code of Conduct, and a comprehensive suite of human resources policies and procedures, including a detailed Dignity & Respect in the Workplace policy and procedure, which obliges all RailCorp employees to:

- (a) not engage in harassment or bullying;
- (b) treat colleagues and customers with dignity and respect at work and during work-related activities;
- (c) think carefully about their own behaviour and how it may impact on others;
- (d) bring instances of harassment or bullying to the attention of their supervisor/manager.

12.99 Under the RailCorp “Just Culture” framework, desired leadership behaviours, aligned to RailCorp’s corporate values, are expected of RailCorp managers and team leaders. The following behaviours are mandated for RailCorp managers in “Just Culture” training:

- (a) Lead by example – demonstrate organisational values;
- (b) Use “Just Culture” principles in everyday management;
- (c) Acknowledge a duty of care to staff;
- (d) Use a consultative not a command and control approach to managing;
- (e) Focus on developing effective communication and teamwork;
- (f) Be a great listener – don’t talk at people;
- (g) Seek to develop your own capabilities and knowledge.

12.100 The “Just Culture” program is being implemented in RailCorp through an extensive program of training, coaching and follow-up, with the full support of RailCorp Board and executive management, and the Minister for Transport.¹⁰⁶

12.101 A comprehensive conflict resolution process, supported by a Grievance Advisory Service,¹⁰⁷ is part of RailCorp’s “Just Culture” model.

Implementation of “Just Culture” in NSW Health

12.102 As set out in my recommendations below, in my view, NSW Health ought introduce a “Just Culture” policy in order to address the absence of respect and proper standards of

behaviour including bullying, inappropriate workplace behaviour and inadequate grievance resolutions practices which help define an uninterrupted work plan.

Recommendation 42: *In order to implement meaningful and long-lasting improvement to its workplace culture, NSW Health, as a key priority, embark immediately on a workplace culture improvement program based on "Just Culture" principles, that clearly identifies acceptable behaviours in the workplace and that is linked to NSW Health corporate values.*

Recommendation 43: *NSW Health should:*

- (a) *engage external expertise to develop the "Just Culture" program;*
- (b) *ensure that all of its senior management personally champion "Just Culture" principles and regard the program as a key priority area for reform;*
- (c) *implement a comprehensive training program for all staff and managers in "Just Culture" principles, to be completed within 3 years;*
- (d) *introduce new procedures for the management of bullying complaints, characterised by fair and reasonable treatment of complainants and respondents, the introduction of timeframes within which complaints need to be resolved and reporting to senior management on the progress of conflict resolution processes;*
- (e) *review existing resources for the management of bullying complaints and implement steps to ensure sufficient numbers of staff are able to handle and resolve complaints in a timely manner;*
- (f) *formulate protocols for, and mechanisms to protect, confidentiality during investigations of bullying complaints, clearly identifying where confidentiality will not be kept (eg if a person discloses self-harm or a criminal offence); and*
- (g) *establish a grievance advisory service to provide independent, objective advice to complainants and respondents in relation to bullying complaints.*

Recommendation 44: *In order to ensure the successful implementation of the "Just Culture" program, I recommend that NSW Health:*

- (a) *implement annual audits to monitor the performance of complaint management systems and compliance with agreed targets; and*
- (b) *measure its success in implementation by reporting on its progress in its annual report.*

¹ NSW Health, *Bullying - Prevention and Management of Workplace Bullying: Guidelines for NSW Health*, GL2007_011.

² NSW Health, *Bullying, Harassment and Discrimination - Joint Management, PSA and Nursing Association Statement*, PD2005_250t.

- 3 NSW Parliament GPSC No. 2 *Inquiry into the Management and Operations of the NSW Ambulance Service*, 22 July 2008, Transcript p. 7.
- 4 NSW Health, *Bullying - Prevention and Management of Workplace Bullying: Guidelines for NSW Health*, GL2007_011.
- 5 Premiers Department, *Dignity and Respect: Policy and Guidelines on Preventing and Managing Workplace Bullying*, M2007-02.
- 6 NSW Health, *Bullying – Prevention and Management of Workplace Bullying: Guidelines for NSW Health*, GL2007_011.
- 7 Confidential Tamworth Hospital hearing, 25 March 2008, transcript 10.12-10.47.
- 8 Confidential Sydney Children’s Hospital hearing, 19 May 2008, transcript 31.44-32.6.
- 9 Confidential Liverpool hearing, 17 April 2008, transcript 25.17-36.34.
- 10 Confidential submission, undated, SUBM.047.0020.
- 11 Confidential submission, 18 March 2008, SUBM.050.0197.
- 12 Confidential Westmead Hospital hearing, 26 May 2008, transcript 78.10-78.16.
- 13 Confidential submission, 15 April 2008, SUBM.069.0128.
- 14 Dr Brodie-Croos, Queanbeyan Hospital hearing, transcript 1744.40.
- 15 Confidential submission, undated, SUBM.028.0215.
- 16 Confidential submission, 27 March 2008, SUBM.027.0334.
- 17 Submission of NSW Nurses’ Association, March 2008, SUBM.042.0335.
- 18 Submission of College of Nursing, March 2008 SUBM.013.0073.
- 19 Diana Gomes, Hornsby Hospital hearing, transcript 239.31-240.31.
- 20 Margo MacKenzie, Mudgee Hospital hearing, transcript 762.16-762.31.
- 21 Confidential Hornsby hearing, 11 March 2008, transcript 7.30-11.28.
- 22 Confidential Armidale hearing, 26 March 2008, transcript 22.12-22.33.
- 23 Confidential Queanbeyan hearing, 15 April 2008, transcript 3.10-3.47.
- 24 Confidential Newcastle hearing, 12 May 2008, evidence transcript 13-14.
- 25 Confidential Westmead Hospital hearing, 26 May 2008, transcript 65.16-66.2.
- 26 Confidential submission, 1 May 2008, SUBM.037.0107.
- 27 Confidential submission, 25 March 2008, SUBM.074.0091.
- 28 Confidential submission, 19 March 2008, SUBM.053.0059.
- 29 Confidential Wollongong hearing, 14 April 2008, transcript 45.2-45.23.
- 30 Anonymous submission, undated, SUBM.001.0208.
- 31 Confidential submission, 18 June 2008, SUBM.077.0120.
- 32 Jane Morley, Westmead Hospital hearing, 26 May 2008, transcript 3207.5-3207.11.
- 33 Helen Ganley, Royal North Shore Hospital hearing, 2 April 2008, transcript 1311.12-1313.26,
- 34 Angela Pridham, Wollongong Hospital hearing, 14 April 2008, transcript 1716.7.
- 35 Confidential Wollongong hearing, 14 April 2008, transcript 24.14-27.1.
- 36 Confidential Prince of Wales Hospital hearing, 1 May 2008, transcript 62.12-73.27.
- 37 Confidential submission, 19 May 2008, SUBM.040.0286.
- 38 Confidential submission, 7 April 2008, SUBM.014.0137.
- 39 Confidential submission, undated, SUBM.076.0323.
- 40 Confidential submission, undated, SUBM.036.0105.
- 41 Confidential submission, 16 April 2008, SUBM.031.0059.
- 42 Confidential submission, 20 May 2008, SUBM.055.0096.
- 43 Confidential Mudgee hearing, 13 May 2008, transcript 2.30.
- 44 Confidential Concord hearing, 24 April 2008, transcript 18.1-18.17.

-
- 45 Confidential Prince of Wales Hospital hearing, 1 May 2008, Transcript 4.38-5.15.
- 46 Confidential Bankstown hearing, 13 May 2008, transcript 25.32-28.18.
- 47 Confidential submission, 22 April 2008, SUBM.040.0136.
- 48 Confidential submission, 7 April 2008, SUBM.074.0034.
- 49 Confidential submission, 11 February 2008, SUBM.006.0058.
- 50 Confidential submission, 18 April 2008, SUBM.024.0100.
- 51 Confidential submission, 5 June 2008, SUBM.074.0124.
- 52 Confidential Lismore hearing, 28 April 2008, transcript 7.19-10.1.
- 53 Confidential submission, 11 April 2008, SUBM.024.0002.
- 54 Confidential submission, 31 March 2008, SUBM.009.0086.
- 55 Confidential submission, undated, SUBM.049.0065.
- 56 Confidential Royal North Shore Hospital hearing, 2 April 2008, transcript 2.34-8.15.
- 57 Confidential submission, 28 May 2008, SUBM.037.0114.
- 58 Confidential submission, undated, SUBM.039.0009.
- 59 Confidential submission, 28 May 2008, SUBM.055.0159.
- 60 See NSW Parliament, General Purpose Standing Committee No. 2 Inquiry into the management and operations of the NSW Ambulance Service; <http://www.parliament.nsw.gov.au/prod/parliament/committee.nsf/0/7E1C5F2F6AD04129CA25744A000801E5>.
- 61 Submission by Cyril Brown (numbered 117) to the NSW Parliament, General Purpose Standing Committee No. 2 Inquiry into the management and operations of the NSW Ambulance Service, 4 July 2008, described the Professional Standards & Conduct Unit as more a "tool of abuse" by the Chief Executive rather than a responsible professional unit that should conduct itself without bias and with fairness.
- 62 Submission by Mrs Carolyn Hodder (numbered 108) to the NSW Parliament, General Purpose Standing Committee No. 2 Inquiry into the management and operations of the NSW Ambulance Service, 21 June 2008.
- 63 NSW Parliament, General Purpose Standing Committee No. 2 Inquiry into the management and operations of the NSW Ambulance Service, 4 July 2008, transcript pages 2-3.
- 64 NSW Health responses to additional questions from the NSW Parliament, General Purpose Standing Committee No. 2 Inquiry into the management and operations of the NSW Ambulance Service, 15 August 2008, question 1; [http://www.parliament.nsw.gov.au/prod/parliament/committee.nsf/0/1fc91afddd352557ca2574b700067a63/\\$FILE/NSW%20Health%20QoN%20combined.pdf](http://www.parliament.nsw.gov.au/prod/parliament/committee.nsf/0/1fc91afddd352557ca2574b700067a63/$FILE/NSW%20Health%20QoN%20combined.pdf)
- 65 NSW Health responses to additional questions from the NSW Parliament, General Purpose Standing Committee No. 2 Inquiry into the management and operations of the NSW Ambulance Service, 15 August 2008, question 1.
- 66 NSW Health responses to additional questions from the NSW Parliament, General Purpose Standing Committee No. 2 Inquiry into the management and operations of the NSW Ambulance Service, 15 August 2008, question 1.
- 67 NSW Health responses to additional questions from the NSW Parliament, General Purpose Standing Committee No. 2 Inquiry into the management and operations of the NSW Ambulance Service, 15 August 2008, question 7.
- 68 NSW Parliament, General Purpose Standing Committee No. 2, *The management and operations of the NSW Ambulance Service*, available at www.parliament.nsw.gov.au.
- 69 Dr Gerard O'Connor, Tamworth Hospital hearing, 25 March 2008, transcript 812.44-813.5.
- 70 Confidential Bathurst hearing, 17 March 2008, transcript 11.12-15.2.
- 71 Submission by Conjoint Professor John Duggan, AM, March 2008, SUBM.004.0104.
- 72 Dr Dean Fisher, Dubbo hearing, 19 March 2008, transcript 654.5.
- 73 Confidential submission, 23 April 2008, SUBM.023.0122.

-
- ⁷⁴ Dr Robert Wright, St Vincents Public Hospital hearing, 30 April 2008, transcript 2478.12-2478.29.
- ⁷⁵ Confidential submission, 18 April 2008, SUBM.043.0201.
- ⁷⁶ Confidential submission, 28 March 2008, SUBM.014.0375.
- ⁷⁷ Confidential Bankstown hearing, 13 May 2008, transcript 66.20-66.36.
- ⁷⁸ Confidential Bankstown hearing, 13 May 2008, transcript 89.21-90.16.
- ⁷⁹ According to Ms Meppem, "skill mix" means the correct ratio of registered nurses to enrolled nurses/trainee enrolled nurses to deal with sick patients. Ms Meppem told me that the workload for nurses is so different from 20 years ago: no longer are patients in hospital "for a rest"; patients one sees in a general ward now would have been Intensive Care Unit patients 20 years ago; this means the pressure at ward level is extreme and why "skill mix" is so important.
- ⁸⁰ Submission by NSW Health, April 2008, SUBM.075.0161
- ⁸¹ NSW Health, *Bullying – Prevention and Management of Workplace Bullying: Guidelines for NSW Health*, GL2007_011.
- ⁸² NSW Health, *Bullying – Prevention and Management of Workplace Bullying: Guidelines for NSW Health*, GL2007_011.
- ⁸³ NSW Health, *Bullying – Prevention and Management of Workplace Bullying: Guidelines for NSW Health*, GL2007_011.
- ⁸⁴ NSW Health, *Bullying, Harassment and Discrimination – Joint Management/Employee Association Policy Statement*, PD2005_223.
- ⁸⁵ NSW Health, *Bullying, Harassment and Discrimination – Joint Management, PSA and Nursing Association Statement*, PD2005_250.
- ⁸⁶ NSW Health, *Zero Tolerance Response to Violence in the NSW Health Workplace*, PD2005_315.
- ⁸⁷ NSW Health, *Training Program: A Safer Place to Work: Preventing and Managing Violent Behaviour in the Health Workplace*, PD2005_316.
- ⁸⁸ NSW Health *Code of Conduct – NSW Health*, PD2005_626.
- ⁸⁹ NSW Health, *Grievance Resolution (Workplace): for the Dept of Health and Public Health Organisations and GL2007_008 Grievance Resolution in the NSW Department of Health, User Guide for Staff & Managers*, PD2005_584.
- ⁹⁰ NSW Health, *Bullying – Prevention and Management of Workplace Bullying: Guidelines for NSW Health*, GL2007_011..
- ⁹¹ NSW Health, *Bullying – Prevention and Management of Workplace Bullying: Guidelines for NSW Health*, GL2007_011.
- ⁹² NSW Health, *Bullying – Prevention and Management of Workplace Bullying: Guidelines for NSW Health*, GL2007_011.
- ⁹³ NSW Health, *Bullying – Prevention and Management of Workplace Bullying: Guidelines for NSW Health*, GL2007_011.
- ⁹⁴ NSW Health Briefing, 28 May 2008, transcript 51.17 to 52.11.
- ⁹⁵ Material for this section of the report obtained from Outcome Engineering LLC, *Just Culture Training for Healthcare Managers*, rev 4, 2008 and *Patient Safety and the Just Culture – Overview*, rev D , 2008. © David Marx, JD and Outcome Engineering LLC. See www.justculture.org.
- ⁹⁶ Walker, SC *Final Report of the Special Commission of Inquiry into Campbelltown and Camden Hospitals*, 30 July 2004, page 89.
- ⁹⁷ See www.justculture.org.
- ⁹⁸ Outcome Engineering LLC, *Just Culture Training for Healthcare Managers*, rev 4, 2008 and *Patient Safety and the Just Culture – Overview*, rev D , 2008. © David Marx, JD and Outcome Engineering LLC.
- ⁹⁹ Banks, Jon M, M.Ed, "To Err is Human ... What Does it Mean?" in *The Just Culture Community News and Views*, Summer edition 2007 – see www.justculture.org.

- ¹⁰⁰ Ibid, page 51 – Example, the employee fails to wear their badge to work because their house was burglarised the previous night and the badge stolen.
- ¹⁰¹ Ibid, page 51 – Example, the employee is late for work because they chose to help someone in the hospital car park who was suffering from chest pain.
- ¹⁰² Alison Page, Fairview Health Services, “Making Just Culture a Reality: One Organization’s Approach” in *AHRQ WebM&M*, <http://www.webmm.ahrq.gov/printviewperspective.aspx?perspectiveID=50>.
- ¹⁰³ Alison Page, Fairview Health Services, “Making Just Culture a Reality: One Organization’s Approach” in *AHRQ WebM&M*, <http://www.webmm.ahrq.gov/printviewperspective.aspx?perspectiveID=50>.
- ¹⁰⁴ Meeting with Jan Potapof, RailCorp, 1 July 2008.
- ¹⁰⁵ RailCorp, *Just Culture Toolkit*, 2007.
- ¹⁰⁶ Meeting with Jan Potapof, RailCorp, 1 July 2008.
- ¹⁰⁷ In 2007, RailCorp established a Grievance Advisory Service, comprising professionals with expertise and experience in conflict resolution, to provide information, coaching and support to complainants (and respondents) about all types of workplace grievances. The Grievance Advisory Service explains the processes for complaint lodging and handling, helps the complainant to make an informed choice about options, comments on draft complaints, talks directly to the grievance handler if the complainant wishes, and works with grievance handlers and HR practitioners handling the complaints. The Grievance Advisory service is able to provide advice to both parties in a complaint, by using different “case officers” for the complainant and the respondent. The Grievance Advisory Service operates via a toll-free number.

